

Francis C. Moon

The Machines of Leonardo Da Vinci and Franz Reuleaux

Kinematics of Machines
from the Renaissance to the
20th Century

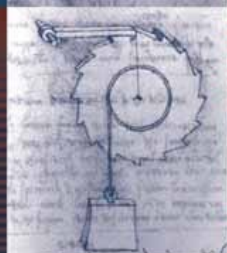
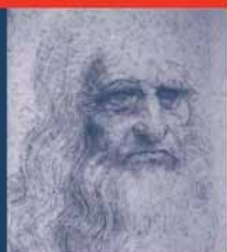

THE MACHINES OF LEONARDO DA VINCI AND FRANZ REULEAUX

HISTORY OF MECHANISM AND MACHINE SCIENCE

Volume 2

Series Editor

G.M.L. CECCARELLI

Aims and Scope of the Series

This book series aims to establish a well defined forum for Monographs and Proceedings on the History of Mechanism and Machine Science (MMS). The series publishes works that give an overview of the historical developments, from the earliest times up to and including the recent past, of MMS in all its technical aspects.

This technical approach is an essential characteristic of the series. By discussing technical details and formulations and even reformulating those in terms of modern formalisms the possibility is created not only to track the historical technical developments but also to use past experiences in technical teaching and research today. In order to do so, the emphasis must be on technical aspects rather than a purely historical focus, although the latter has its place too.

Furthermore, the series will consider the republication of out-of-print older works with English translation and comments.

The book series is intended to collect technical views on historical developments of the broad field of MMS in a unique frame that can be seen in its totality as an Encyclopaedia of the History of MMS but with the additional purpose of archiving and teaching the History of MMS. Therefore the book series is intended not only for researchers of the History of Engineering but also for professionals and students who are interested in obtaining a clear perspective of the past for their future technical works. The books will be written in general by engineers but not only for engineers.

Prospective authors and editors can contact the Series Editor, Professor M. Ceccarelli, about future publications within the series at:

LARM: Laboratory of Robotics and Mechatronics
DiMSAT – University of Cassino
Via Di Biasio 43, 03043 Cassino (Fr)
Italy
E-mail: ceccarelli@unicas.it

For a list of related mechanics titles, see final pages.

The Machines of Leonardo da Vinci and Franz Reuleaux

Kinematics of Machines from the Renaissance
to the 20th Century

By

FRANCIS C. MOON

*Mechanical and Aerospace Engineering,
Cornell University,
Ithaca, New York, USA*

A C.I.P. Catalogue record for this book is available from the Library of Congress.

ISBN 978-1-4020-5598-0 (HB)

ISBN 978-1-4020-5599-7 (e-book)

Published by Springer,
P.O. Box 17, 3300 AA Dordrecht, The Netherlands.

www.springer.com

Cover figures: Self portrait of Leonardo da Vinci, Royal Library Turin; Leonardo's ratchet drawing from *Codex Madrid*, National Library Madrid; Portrait of Franz Reuleaux and ratchet mechanism drawing from *Kinematics of Machinery*, Franz Reuleaux (1876)

Every effort has been made to contact the copyright holders of the figures which have been reproduced from other sources. Anyone who has not been properly credited is requested to contact the publishers, so that due acknowledgements may be made in subsequent editions.

Printed on acid-free paper

All Rights Reserved

© 2007 Springer

No part of this work may be reproduced, stored in a retrieval system, or transmitted in any form or by any means, electronic, mechanical, photocopying, microfilming, recording or otherwise, without written permission from the Publisher, with the exception of any material supplied specifically for the purpose of being entered and executed on a computer system, for exclusive use by the purchaser of the work.

To Lee, my helpmate in this six-year project; she is the only one I know who can read Reuleaux's handwriting.

Contents

Preface by the Series Editor, Professor M. Ceccarelli	xi
Preface	xiii
Acknowledgements	xvii
Notes	xxi
List of Figures	xxiii
List of Tables	xxxiii

PART I

I Leonardo da Vinci and Franz Reuleaux: Machine Engineers ..	3
I.1 Introduction	3
I.2 Modern Applications of Kinematics: Leonardo in Your Toothbrush	15
I.3 Deconstructing the Machine: Constructive Elements of Design	27
I.4 Leonardo, ‘Ingenieur Ordinaire’	37
I.5 Franz Reuleaux: Engineer-Scientist	47
I.6 Influence of Leonardo da Vinci on 19th C. Machine Theorists	59
I.7 Kinematics of Machines: The Geometry of Motion	66
I.8 Visual and Topological Thinking: Reuleaux’s Language of Invention	76
I.9 Summary	96

PART II

II Evolution of Design of Machines 99

II.1 Introduction 99

II.2 Visual Kinematic Perception of Mechanisms 102

II.3 Ancient Greek and Roman Machines 107

II.4 Machines in the Bible 116

II.5 Roger Bacon on Marvelous Machines in the 13th Century ... 118

II.6 Machines of the Middle Ages 121

II.7 Scientific and Technical Milieu in the Renaissance Machine Age 125

II.8 Francesco di Giorgio Martini: The Leonardo of Siena 135

II.9 Theatre of Machines Books: Imitation or Invention? 146

II.10 Mathematics, Mechanics and Design of Machines 160

II.11 Art and the Machine Engineer 175

II.12 Concepts of Design and Invention by Leonardo and Reuleaux 188

II.13 Models as the New ‘Theatre of Machines’ 199

II.14 James Watt and the Steam Engine: Pathways of Machine Evolution 212

II.15 Machine Engineers and Inventors in the 19th Century 223

II.16 Berlin and the Machine Age of the 19th Century 228

II.17 Lost Knowledge from the Age of Machines: Mathematical Kinematics and Rotary Engines 239

II.18 Prime Mover Machines: Thermodynamics, Kinematics and Materials 248

II.19 Flying Machines of Leonardo and Lilienthal 255

II.20 Kinematics of Animal and Human Motion 262

II.21 Leonardo in a Robot: Automata, Clocks and Controlled Machines 276

II.22 Leonardo and Reuleaux: A Summary 289

Color Plates 293

PART III

III Comparison of the Kinematic Mechanisms of Leonardo and Reuleaux 303

PART IV

IV References, Bibliography & Appendices	351
Cited References	351
Books on the Life of Leonardo da Vinci and as Machine Engineer .	364
Books on the History of Machines in the Industrial Age.....	365
Books on the History of the Renaissance in Europe	366
Books and Articles on Franz Reuleaux and the Kinematic Theory of Machines	366
Books and Articles on Kinematics of Human and Animal Motion .	368
History of Machines-related Books for a Teaching, Design Studio Library	369
Appendix I: A Summary of ‘Theatre of Machines’ Books 15th–18th Centuries	372
Appendix II: On-Line Books and Papers at Cornell University Library on The History of Machines and Mechanisms	391
Appendix III: Student Exercises in the History of Machines	394
Author Index	401
Subject Index	407
About the Author	417

Preface by the Series Editor, Professor M. Ceccarelli

This book is part of a book series on the History of Mechanism and Machine Science (HMMS).

This series is novel in its concept of treating historical developments with a technical approach to illustrate the evolution of matters of Mechanical Engineering that are related specifically to mechanism and machine science. Thus, books in the series will describe historical developments by mainly looking at technical details with the aim to give interpretations and insights of past achievements. The attention to technical details is used not only to track the past by giving credit to past efforts and solutions but mainly to learn from the past approaches and procedures that can still be of current interest and use both for teaching and research.

The intended re-interpretation and re-formulation of past studies on machines and mechanisms requires technical expertise more than a merely historical perspective, therefore, the books of the series can be characterized by this emphasis on technical information, although historical development will not be overlooked.

Furthermore, the series will offer the possibility of publishing translations of works not originally written in English, and of reprinting works of historical interest that have gone out of print but are currently of interest again.

I believe that the works published in this series will be of interest to a wide range of readers from professionals to students, and from historians to technical researchers. They will all obtain both satisfaction from and motivation for their work by becoming aware of the historical framework which forms the background of their research.

I would like to take this opportunity to thank the authors and editors of these volumes very much for their efforts and the time they have spent in order to share their accumulated information and understanding of the use of past techniques in the history of mechanism and machine science.

Cassino, April 2007

Marco Ceccarelli (Chair of the Scientific Editorial Board)

Preface

Ah the Machine; both coveted and criticized, life sustaining and life destroying yet always a symbol of human creativity and invention from the Renaissance to robotics from the Wright brothers to the Wankel engine. There are more than a billion mechanical machines in our world of six billion humans. These machines are the source of both marvel and mayhem in the life of our planet. This book is about the evolution of these machines and the inventors and engineers who created them from the early Renaissance to the early 20th century. I have chosen two personalities who are icons of these two machine ages, Leonardo da Vinci [1452–1519] and Franz Reuleaux [1829–1905], recognizing both the cadre of machine designers who influenced them as well as those who were influenced by the accomplishments of these two engineers. A major thesis of this book is that the evolution of machine design methodology, from the intuitive methods of the workshop to the math-based, engineering science analysis and synthesis of modern industrial design, was of equal achievement as the creation of the marvelous machines themselves.

In the past two decades there has been increasing interest in rational methods of design from topology and optimization theories to genetic algorithms. In the teaching of design at the novitiate level, the importance of design cycles and iteration is emphasized. Yet often the historical background for evolution of machine design is minimal or missing. With this book we provide an overview of design evolution from the Renaissance period to the early 20th century.

Why another book on machine evolution? Certainly there have been a long series of works that have both surveyed and analyzed machine evolution as well as Leonardo's drawings of machines such as Abbott P. Usher (1954),

Eugene Ferguson (1968), Bertram Gille (1966), Charles Gibbs-Smith (1978) and Ladislao Reti (1974) and more recently G. Bassala (1988). In the period, 1960–80, there appeared many encyclopedic works such as Singer et al (1961), Emberto Eco (1966) and Joseph Needham (1965) as well as translations and facsimiles of classic ‘theatre of machines’ books such as Taccola (1455) and Ramelli (1588). This book cannot hope to compete with the scholarly nature of those books. However this group of scholars has largely stepped off the stage of the history of technology. The mainstream of the history of technology has shifted its focus from scientific and technical issues, to social, cultural, economic and gender questions about technology, especially dealing with the post machine age era of the 20th century. However, new questions about the complexity of modern technology cannot be entirely separated from the early history of machines, given the premise of the evolution of technology.

And why another book on Leonardo da Vinci? Surely there have been hundreds written on this paragon of the Italian Renaissance and dozens about Leonardo as inventor and scientist. However many of these works were written before the discovery of Leonardo’s *Codex Madrid* in 1965. This previously lost work reveals Leonardo’s interest in a theory of machines and machine design, not simply clever inventions. Also recent work on the contributions of Francesco di Giorgio (1439–1501) and other Tuscan artist-engineers have put some of Leonardo’s oft-cited inventions in a wider context of contemporary Renaissance technology. This new status for Leonardo may diminish his role as an inventor but raises his image as a precursor of the mathematics and science-based engineer that Franz Reuleaux and his generation realized in the polytechnique schools of the 19th century.

And why study Franz Reuleaux? Most casual readers will not recognize the name. However in the works of most of the important historians of machines, such as Beck, Usher, Burstal, Eco, Ferguson and Reti, Reuleaux’s name is cited as one of the greatest machine theorists of the 19th century. As the reader will discover in the text to follow, Reuleaux was known as the ‘*father of kinematics of machines*’. During the height of his fame, the German engineer, of Belgian descent, was recognized around the world. After his death in 1905, his reputation faded, only to be rediscovered in the past decade in many mathematical and engineering works. He was one of the first proponents of a theory of machine invention and posited a series of principles of design that were a century ahead of his time. Mathematicians now cite his early work on so-called ‘curves of constant width’ and some high school geometry classes teach about the ‘Reuleaux triangle’.

In writing this book, I have taken a chance that there is a new generation of readers like myself who missed this earlier era of the history of machines in the 1960s and still respond with awe and wonder at the inventiveness of humankind in creating machines. Another reason for writing this book is to continue a theme put forward by the Leonardian scholar Ladislao Reti when he translated the rediscovered *Codex Madrid* in 1965. Reti posited the thesis that Leonardo had planned a book on basic machine elements of design. In Reti's thesis he compared Leonardo's machine drawings with the basic constructive elements proposed by Franz Reuleaux in his famous theory of machines published between 1854 and 1876. The Cornell University Library has recently added over 50 rare books on the theory of machines on the web including Leonardo's *Codex Madrid I* and translations of Reuleaux's two important works. This book will, I hope, serve as a guide to some of these works that the reader can now access without visiting a major library.

Lastly I have undertaken this work to showcase one of Reuleaux's major contributions, the creation of a mechanical alphabet of over 800 models of machine mechanisms in Berlin. This mechanical alphabet went beyond the earlier 18th century work of Christopher Polhem of Sweden and the early 19th century attempt of Charles Babbage to create a language of invention. The bulk of Reuleaux's Berlin collection of models did not survive WWII. However a large subset of this collection (over 230 models) was reproduced and acquired by Cornell University in 1882. I have attempted to compare some of the 19th century kinematic Reuleaux models with the 15th century designs of mechanisms of Leonardo da Vinci as a way of comparing the methodology of machine design in the 15th and 19th centuries.

My own path to writing this unorthodox book has been rather circuitous. I spent the greater part of my career in academic research and teaching in the field of theoretical and applied mechanics and dynamics, especially nonlinear dynamics and chaos theory mostly ignoring the subjects of machines and machine design. During the decades of the 1960s thru the 1980s, the Cornell Kinematic Collection was in benign neglect and almost no one knew who Reuleaux was. However during travels to Germany in the late 1980s under a Humboldt Foundation award, several European colleagues brought my attention to the importance of the Collection. When a Berlin Museum tried to purchase the Cornell Collection during my tenure as Director of the Sibley School of Mechanical and Aerospace Engineering, my curiosity was piqued and I started on a decade-long road of research and study about Reuleaux, the history of machines and inevitably to the question of Leonardo da Vinci's place in the history of machines.

Through my research on Reuleaux and the history of machines, I was surprised to learn of the major role that Cornell's Sibley College of Mechanical Engineering played in the development of mechanical engineering in the 19th century. Cornell Professor Robert Thurston, originally from Stevens Institute, was the first president of the American Society of Mechanical Engineers and three other Sibley faculty were presidents. Thurston met Reuleaux in 1873 in Berlin and Reuleaux translated one of Thurston's books into German. During this period Cornell not only acquired copies of a substantial part of the Reuleaux model collection in Berlin, but also built an important library of the most significant European books on the theory of machines, a collection I was fortunate to use for this book.

This book is also a supplement to a Cornell project to place the Reuleaux Collection in a virtual museum on the web as part of the United States National Science Digital Library or NSDL. We have also digitized many of the famous books in the Cornell History of Science Library on the history of machines from the 15th to the 19th century. This website called KMODDL, for Kinematic Models for Design Digital Library (<http://kmoddl.library.cornell.edu>), has had several hundred thousand visitors in its short life thus far, and the reader of this book can find pictures and movies of many of the machines and mechanisms on this website.

Acknowledgements

In writing this book I have been fortunate to have access to three major resources; the Cornell Collection of Kinematic Models, the Archive of the Deutsches Museum in Munich and the Cornell University Library, Rare and Manuscript Collection.

As faculty curator for the Cornell Collection of Kinematic Models, I have had daily access to the 230 Reuleaux kinematic models made by Gustav Voigt of Berlin in 1882. This project began over a decade ago during a 1995 sabbatical leave visit to Germany, where colleagues told me of the importance and fame of Franz Reuleaux and his kinematic model collection. In 2001 and 2002 I returned to Germany to study the Reuleaux papers in Munich as well as visit the Technical University of Berlin where he was professor and rector.

I am grateful to the Humboldt Stiftung of Germany for financial support to visit and study the Reuleaux archives and collections of the Deutsches Museum in Munich. This visit would not have been possible without the support from my friend and colleague Professor Franz Kollmann formerly with The Technical University of Darmstadt. Of particular help at the Deutsches Museum were Dr. Wilhelm Füssl, head of the Archiv, Karl Allwang, Curator for Mechanical Engineering, Manfred Spachtholz, Museum engineer and Mr. Sebastian Remberger.

Thanks are also due for support from the Cornell University Library staff, especially John Saylor, Director of the Engineering Library. Help is also acknowledged from Dr. David Corson, Head of the Rare and Manuscripts Collection and Dr. Elaine Engst, University Archivist. The Dibner Library at the Smithsonian Institution in Washington was a valuable resource as well as the

Library of Congress and the library of the American Philosophical Society in Philadelphia of which Franz Reuleaux was a member.

In Germany I also had help from Professor Reinhard Braune of the Institut für Getriebetechnik and the late Professor Karl Popp of the University of Hannover, Professor Friedrich Pfeiffer of the Technical University Munich, Professor Modler, and Professor Klaus Mauersberger, Technical University of Dresden. Thanks are also due to Professor Jörg Wauer of the Universität Karlsruhe for access to and for cataloging the Redtenbacher model collection, Professor D. Severin, of the Technical University of Berlin, Professor Dittrich and Professor Burkhard Corves for access to the kinematic model collection in the Rhein.-Westf. Technische Hochschule Aachen. I fondly remember my meeting in Berlin of the great grandson of Franz Reuleaux, Dr. Henning Reuleaux, who related some family stories about him.

In Italy I had help in retracing the paths of Leonardo da Vinci in Milan by Roberto Bragastini, a retired engineer and historian who arranged a visit to the Biblioteca Ambrosiana and to the Leonardo machine models at the Museo Scienza in Milan. In Florence thanks are due to Dr. Paolo Brenni, Fondazione Scienza e Tecnica/Istituto e Museo, Firenze.

A resurgence of interest in the history of machines has been sparked by the History of Machines and Mechanisms Commission, of the International Federation for the Theory of Machines and Mechanisms (IFTToMM), headed by Professor Marco Ceccarelli, University of Cassino, Italy who kindly invited me to several important workshops of IFTToMM in Cassino, Dresden and Moscow. My thanks are also offered to Professor H-S. Yan of National Chen Kung University, Taiwan, the current head of the HMM Commission.

In England I would like to thank Dr. Hugh Hunt, Engineering Department, Cambridge University for help in viewing the Robert Willis sketch book and the Cambridge kinematic model collection. At the Science Museum London I was able to visit the storage and archives through help from curators Mr. Michael Wright and Ben Russel. They also gave me access to original photos of the 1876 Kensington Scientific Instrument Exhibition at which were 300 models of Reuleaux. Special thanks also go to Gerald H.F. Seiflow (retired engineer and Reuleaux relative) of Leicester England for information on the Reuleaux family tree.

I was also privileged to have been given access to machine model collections at the Technical University of Dresden, The University of Porto, Portugal, the Hauch Physike Cabinet in Sorø Denmark, the Rothschild Patent Model Museum in Cazenovia New York, and the Bauman Moscow State Technical University Kinematic Collection.

I also want to acknowledge help from the late Professor Werner Goldsmith of the University of California Berkeley, Dr. S. Shiroshita, Kyoto University Museum, Jørgen F. Andersen of Sorø Academy, Denmark, Professor Hanfreid Kerle, Braunschweig and Professor Paulo M.S. Tavares de Castro, Universidade do Porto and Professor Alexandre Golovin and Dr. Valentin Tarabarin, Moscow. For help with the ASME historic designation for the Cornell Reuleaux Collection, I thank Professor Robert Friedel, University of Maryland, Diane Kaylor, ASME Heritage Committee, and Aaron J. Boltman of the ASME Southern Tier Section.

This book was also inspired by a Cornell project to place the Reuleaux Collection in a virtual museum on the web called KMODDL or *Kinematic Models for Design Digital Library* (<http://kmoddl.library.cornell.edu>). KMODDL is a part of the United States National Science Digital Library (www.nsdlib.org). I have enjoyed the fruitful interaction with the KMODDL team; Dr. Daina Taimina and Professor David Henderson of the Mathematics Department, Professor Hod Lipson of Mechanical and Aerospace Engineering, John Saylor Principal Investigator of the KMODDL project and Engineering Librarian, and Dr. Kizer Walker, Digital Projects, University Library. The help of KMODDL webmaster Matt Arnstein is also acknowledged, as well as graduate students David Caruso and Javier Lezaun of the Science and Technology Studies Department. Special thanks are due to Professors Emeriti Richard Phelan and Jack Booker who were the early custodians of the Reuleaux Collection at Cornell.

Thanks also to those who gave me helpful feedback from an early edition of this book, especially Professor David Ollis, North Carolina State University, Professor Emeriti Franz Kollman, Darmstadt Technische Hochschule, Dr. Klaus Mauersberger, Technische Universität Dresden, Professor Teun Koetsier, Vrije Universiteit Amsterdam and Professor Marco Ceccarelli, University of Cassino, Italy.

The author wishes to thank his editor at Springer, Nathalie Jacobs, and Jolanda Karada (Karada Publishing Services) for their support and attention to details in the production of this book.

Finally special thanks are due my wife Elizabeth E. Moon for transcriptions of the Reuleaux letter copy books in the Archiv of the Deutsches Museum, for copy editing many of the references in the book and for continuous encouragement and patience for my obsession with this project.

Photo credits

All photos in this book are by the author unless noted otherwise. Images from ‘theatre of machines’ books courtesy Cornell University Library. Details of machines and mechanisms of Leonardo da Vinci from *Codex Atlanticus* or *Il Codice Atlantico della Biblioteca Ambrosiana di Milano/Leonardo da Vinci*, facsimile edition: published by Regis Accademia dei Lincei, 1894–1904. Details of machines and mechanisms from *Codex Madrid* or *Tratado de Estatica y Mechanica en Italiano, 1493*, facsimile edition: *The Madrid Codices, National Library Madrid, No. 8937*, McGraw-Hill Book Company, NY, 1974. Figure II.1 Greek Antikythera Mechanism (de Solla Price, 1959), courtesy Scientific American, Figure II.43 Knee joint mechanism (Menschik, 1987), courtesy Springer Verlag, Berlin. Figure II.44, Chinese walking horse, courtesy Prof. H-S. Yan, Tainan University, Taiwan, Figure II.45, Passive walking machine, courtesy Prof. Andy Ruina, Cornell University.

Notes

Note to the Reader

There are four parts to this book each of which may be of interest to different readers. The author has written this book in the hope that it will find interest in the engineering community, the history of technology community as well as the lay reader. The first two parts are narrative and are written for non-technical as well as technical readers. Part III is a catalog of machine elements and mechanisms of Leonardo and Reuleaux that may find interest in teaching engineering design. Part IV contains over 300 references as well as a comprehensive annotated list of the so-called ‘Theatre of Machines’ books. Part IV also contains a list of project and problems for students and classroom use.

The author recognizes that each type of reader is used to a different style of reference, be it footnotes, endnotes or a list of references at the end of the book. Coming from the academic engineering tradition, the author has adopted the ‘Author (date)’ format for references with an alphabetical list at the end of the book. Historical dates such as [birth–death] are listed in square brackets.

References to the work of Leonardo da Vinci follows traditional format of citing the codex and the folio number:

Codex Atlanticus = CA; Folio number recto or verso

Codex Madrid = CM; Folio number recto or verso

Institute of France Manuscripts = Ms A etc.

In the reference to early manuscripts, the letter ‘r’ is for *recto* and ‘v’ is for *verso*. There are several different facsimiles of Leonardo’s codices. The folio number follows the more recent pagination. In the case of the *Codex Atlanti-*

cus the folios were renumbered in the last decades of the 20th century, I have used the new folio numbers first with the old numbers cited second.

Note to the Teacher and Student

The author hopes that this book will be useful in the teaching of several disciplines related to the history and design of machines. For this purpose a selection of problems and projects are included in Part IV of this book. Some of these exercises have been used in a sophomore design synthesis course in mechanical engineering at Cornell University. The Reuleaux models have also been used in an introductory architectural drawing course as well as courses in Computer Aided Design (CAD).

The material in this book can also be used for projects in the history of science and technology such as the comparative study of engineer-inventors, machine technology and sociological aspects of technology (see Part IV, Appendix II).

List of Figures

I.1	Portrait of Leonardo da Vinci [1452–1519]	5
I.2	Portrait of Franz Reuleaux [1829–1905]	6
I.3	Reuleaux’s six classes of kinematic mechanisms from <i>Kinematics of Machinery</i> (1876)	8
I.4a	Comparison of kinematic elements in machine design from the books of Franz Reuleaux (on the left) and drawings of Leonardo da Vinci from the <i>Codex Madrid I</i> (on the right). See also Table I.3	9
I.4b	Comparison of kinematic elements in machine design from the books of Franz Reuleaux (on the left) and drawings of Leonardo da Vinci from the <i>Codex Madrid I</i> (on the right). See also Table I.3	10
I.5	Selection of 350 kinematic models from Voigt Catalog of Reuleaux Models (c. 1900)	11
I.6	The Angel of Machines: from <i>Buch der Erfindungen Gewerbe und Industrien</i> , or Book of Inventions, Vol. 6, 1887, F. Reuleaux, Editor	13
I.7	Landing gear linkage for an Airbus jet. (Science Museum, London)	17
I.8	Micro-electromechanical System [MEMS] gear train; Courtesy: Sandia National Laboratory	17
I.9	Modern robotic manipulator arm with end effector gripper . . .	20
I.10a	Sketch of the mechanisms in a modern electronic toothbrush: Braun Model	22
I.10b	Sketch of the mechanism in a motorized toothbrush: Colgate Model	23
I.11a	Four-link mechanism of Leonardo da Vinci (<i>Codex Madrid I</i>)	24

I.11b	Slider-crank mechanism (<i>Codex Madrid I</i>)	24
I.11c	Gear and pinion (<i>Codex Madrid I</i>)	24
I.12	Top: toothbrush with crown wheel gear and pinion and slider-crank mechanism. Middle: Crown wheel gear and lantern pinion of Leonardo da Vinci from the <i>Codex Madrid I</i> . Bottom: Double slider-crank mechanism and worm gear drive of Leonardo da Vinci from the <i>Codex Madrid I</i>	25
I.13	First automobile of Carl Benz and the list of basic machine elements and mechanisms (c. 1885) (Courtesy of the Deutsches Museum, Munich)	29
I.14	Left: kinematic pairs; Right: (a) slider crank and (b) four-bar kinematic chains	30
I.15	Sketch of kinematic elements in Leonardo's textile spinning machine (based on <i>Codex Atlanticus</i> , Folio 1090v)	35
I.16	Leonardo da Vinci: Exploded view of a ratchet winch (<i>Codex Atlanticus</i> , Folio 30v/8v.b)	40
I.17	Influence network of Leonardo da Vinci	45
I.18	Influence network of Franz Reuleaux in the 19th century related to the kinematics theory of machines	55
I.19	Compilation of machine elements of Leonardo da Vinci by Theodor Beck (1899) after Grothe (1874)	64
I.20	Table of kinematic motions from Lanz and Betancourt (1809) after Hachette, Ecole Polytechnique	67
I.21	Sketch of anti-friction ball bearing of Leonardo da Vinci (<i>Codex Madrid I</i> , Folio 20v)	67
I.22	Sketch of planetary gear mechanism of Leonardo da Vinci (<i>Codex Madrid I</i> , Folio 13v)	68
I.23	Sketch of helical screw mechanism, Leonardo da Vinci (<i>Codex Madrid I</i> , Folio 57v)	69
I.24	Kinematic chain for a four-bar mechanism (Reuleaux, 1876a)	72
I.25	Centrodes or rolling curves for a four-bar mechanism (Willson, 1898)	73
I.26	Path points of motion of a Reuleaux triangle in a square bearing (Reuleaux, 1876a, plate VIII, figure 1)	73
I.27a	Inversions of the slider-crank mechanism (Reuleaux, 1876a)	82
I.27b	Expansion of elements of the slider-crank mechanism (right) into an eccentric mechanism (left). (Models from the Cornell Kinematic Mechanisms Collection: See models C-2, E-2, on the KMODDL website)	83

I.28	Sample symbol table for mechanisms from Reuleaux's <i>Kinematics of Machinery</i> (1876), for slider linkages and rotary pump-engine mechanisms	86
I.29	Kinematic circuits and symbols based on Reuleaux, published by Francesco Masi (1883)	87
I.30	Six-bar compound mechanism with one degree of freedom (Reuleaux, 1876a)	90
I.31	Reuleaux straight-line mechanism with six links and seven joints. ($F = +1$) Model S-32 in the Voigt catalog. (Cornell Kinematics Model Collection)	91
I.32	Table of eight-bar linkages with one degree of freedom when one bar is grounded (Grübler, 1917)	92
I.33	Peaucellier exact straight-line mechanism with eight links and ten revolute joints: one degree of freedom with one link grounded. (Reuleaux–Voigt Model S-35, Cornell Kinematic Mechanisms Collection; See also KMODDL website)	93
I.34	Sketch of Leonardo's 'lazy tongs' or 'Nürnberg shears' mechanism of Leonardo da Vinci; six links and seven revolute joints	94
II.1	Partial reconstruction of Greek Antikythera Mechanism by D. de Solla Price. This multiple gear device is believed to have been used to calculate the motions of the planets. (Scientific American, 1959, with permission)	101
II.2	Moving point lights experiment in kinematic perception of walking humans. (Johansson, 1973, 1975)	103
II.3	Six simple machines of antiquity	108
II.4	Wheeled chariot, Neo-Assyrian, 800 BC (Pergamon Museum, Berlin)	109
II.5	Lumber-cutting machine drawing by Francesco di Giorgio di Martini (15th C.) after Villard de Honnecourt (c. 1225)	119
II.6	Leonardo's drawing one of the Platonic solids for Fra Luca Pacioli's <i>De Divina Proportione</i> (1505). (Courtesy Cornell University Library)	130
II.7	Machine drawing hoist of Taccola (Mariano di Iacopo)	132
II.8	Portrait of Madonna by Francesco di Giorgio Martini [1439–1501] in the Siena Pinacoteca Nazionale	136
II.9	Drawing of water pumps with valves by Francesco di Giorgio Martini (c. 1460)	142

II.10	Drawing of four-wheeled carts with steering mechanism by Francesco di Giorgio Martini	143
II.11a	Design for a log-cutting machine by Besson (1578)	152
II.11b	Design for a log-cutting machine by Ramelli (1588)	152
II.12a	Log-cutting machine drawing of G.A. Böckler (1662)	154
II.12a	Double-piston pump drawing of Vittorio Zonca [1568–1602] .	154
II.13	Machine elements drawings (ratchets) of Jacob Leupold (1724)	155
II.14a	Mechanism classification table from Borgnis (1818)	157
II.14b	Drawings of mechanisms from catalog of Henry Brown (1868)	158
II.15	Leonardo’s quadrature of the cube using 6 tetrahedra. (<i>Codex Madrid II: Folio 70r</i>)	163
II.16	Path points of moving links; drawing of Leonardo da Vinci (<i>Codex Madrid I, Folio 63v</i>)	166
II.17	Architectural elements in steam engine design (Smithsonian Institution, Washington DC)	176
II.18	Reuleaux’s designs for bearings pedestals in machines (Courtesy Deutsches Museum Archive)	177
II.19	Kinetic sculpture with gears by contemporary artist Arthur Ganson (MIT Museum)	179
II.20	Engraving by Albrecht Dürer; ‘Triumphzug Kaiser Maximilians’ (1515) (Scherer, 1907)	182
II.21	Engraving by Albrecht Dürer: ‘Triumphzug Kaiser Maximillians’ (1515), showing two endless screw mechanisms (Scherer, 1907).	184
II.22a	Print of Peter Bruegel [c. 1520–1569] of two post windmills. (In <i>Estampes de Peter Bruegel l’ancien</i> , by R. van Bastelaer, 1908)	185
II.22b	One of many studies for ‘The Drawbridge’ by Vincent van Gogh (c. 1888) with four-bar mechanisms. (In <i>Vincent van Gogh; A Biographical Study</i> , by J. Meier-Graefe, 1922, plate xxvii)	186
II.23	Comparison of ‘globoid’ gear designs of Leonardo da Vinci (top) and Franz Reuleaux (bottom)	192
II.24	A sampler of gear designs by Leonardo da Vinci (<i>Codex Madrid I</i>)	196
II.25	Top: Leonardo da Vinci drawing of a wing in the <i>Paris Manuscripts</i> ; Ms. B Folio 88 verso. Bottom: Model of a wing by Leonardo in the Museo Nazionale delle Scienza e della Tecnica Leonardo da Vinci, Milano	202

II.26	Rapid prototype models of historic machines (Lipson et al., 2005). Top: Worm gear and slider-crank mechanism of Leonardo da Vinci (<i>Codex Madrid</i>); Bottom: Rapid prototype ‘printed’ model	210
II.27	Sketch of steam engine components of James Watt, 1784	214
II.28	Reuleaux–Voigt model of a Watt straight-line mechanism (Cornell University Collection of Kinematic Models)	221
II.29a	Robert Willis p[1800–1875] Professor, Cambridge University. Forerunner of rational machine design. (Photo, Royal Society of London)	224
II.29b	Drawing of Willis of mechanism for Babbage’s Difference Machine calculator. (Courtesy, Cambridge Univ. Engineering Library)	224
II.30	Professor Ferdinand Redtenbacher [1809–1863], Teacher of Franz Reuleaux, Eugen Langen and Karl Benz; Karlsruhe Polytechnic School, Germany	226
II.31	The Technische Hochschule Charlottenburg, Berlin c. 1900 . .	230
II.32	Top: Reuleaux Triangle model (Cornell Collection of Kinematic Mechanisms); Bottom: Lunate drawing of Leonardo da Vinci, with a curved triangle figure in the center (Paris Manuscript A, Folio 15v)	240
II.33	Drawing of Thomas Arithmometer by Franz Reuleaux (1862)	242
II.34	Reuleaux–Voigt Model S-35 of a Peaucellier straight-line mechanism (Cornell Collection of Kinematic Mechanisms) . .	243
II.35	Reuleaux rotary engine models (Cornell Collection of Kinematic Mechanisms)	245
II.36a	Wankel engine	246
II.36b	Wankel’s classification chart for rotary engines	246
II.37	Oliver’s Evans steam engine of 1803 (Thurston, 1878)	249
II.38	Leonardo da Vinci sketch for an experiment to measure the expansion of steam	250
II.39	Ornithopter design of Leonardo da Vinci, <i>Paris Manuscripts</i> .	256
II.40	Otto Lilienthal aircraft design sketch circa 1889 (Archives of the Deutsches Museum, Munich)	260
II.41	Left: Drawing of an arm by Leonardo da Vinci; Right: Drawing of an arm by Reuleaux (1900)	265
II.42	Man in the machine; sketch from Borgnis (1818)	269
II.43	Four-bar mechanism replacement for a knee joint (Menschik, 1987)	272

II.44	Chinese ‘walking horse’ design of H.-S. Yan (2005), Tainan University, Taiwan	273
II.45	Passive walking machine, Professor Andy Ruina, Cornell University (see Collins et al., 2005)	274
II.46	Automaton cart and possible automaton pulley system of Leonardo da Vinci (<i>Codex Atlanticus</i> ; upper Folio 812r/folio 296v.a; lower Folio 579r/folio 216v.b)	277
II.47	Modern Japanese Tea-serving Doll automaton (courtesy of S. Shiroshita, Museum of Kyoto University)	280
II.48	Clock and bell-ringing mechanism models of Reuleaux (Cornell Collection of Kinematic Mechanisms)	284
II.49	Chart of Influence of Renaissance Engineers after Reti (1963)	292

COLOR PLATES

1	Close-up of positive displacement pump of Dart. Reuleaux–Voigt Model I-7, Cornell University Collection of Kinematic Models, nickel-plated brass and cast iron, Berlin, circa 1882 (Photo, F.C. Moon)	295
2	Clemen’s universal joint coupling. Reuleaux–Voigt Model P-3, Cornell University Collection of Kinematic Models, nickel-plated brass and cast iron, Berlin, circa 1882 (Photo, F.C. Moon)	295
3	Geneva-wheel intermittent mechanism for watches. Reuleaux–Voigt Model N-8, Cornell University Collection of Kinematic Models, nickel-plated brass and cast iron, Berlin, circa 1882 (Photo, F.C. Moon)	296
4	Close-up of ratchet-wheel coupling. Reuleaux–Voigt Model N-7, Cornell University Collection of Kinematic Models, nickel-plated brass and cast iron, Berlin, circa 1882 (Photo, F.C. Moon)	296
5	Close-up of planetary gear train. Reuleaux–Voigt Model G-3, Cornell University Collection of Kinematic Models, nickel-plated brass and cast iron, Berlin, circa 1882 (Photo, F.C. Moon)	297
6	Positive-return cam with Reuleaux triangle. Reuleaux–Voigt Model L-6, Cornell University Collection of Kinematic Models, nickel-plated brass and cast iron, Berlin, circa 1882 (Photo, F.C. Moon)	297

7	Spiral positive-displacement pump. Reuleaux–Voigt Model I-4, Cornell University Collection of Kinematic Models, nickel-plated brass and cast iron, Berlin, circa 1882 (Photo, F.C. Moon)	298
8	Worm gear and rack. Illinois Gear Corp. Model, Cornell University Collection of Kinematic Models, brass and cast iron, Chicago, circa 1950 (Photo, F.C. Moon)	298
9	Close-up of cylinder escapement for a clock. Reuleaux–Voigt Model X-3, Cornell University Collection of Kinematic Models, nickel-plated brass and cast iron, Berlin, circa 1882 (Photo, F.C. Moon)	299
10	Close-up of gear teeth for rack and pinion mechanism. Reuleaux–Voigt Model Q-1, Cornell University Collection of Kinematic Models, nickel-plated brass and cast iron, Berlin, circa 1882 (Photo, F.C. Moon)	299
11	Planetary gear and four-bar linkage. Reuleaux–Voigt Model O-1, Cornell University Collection of Kinematic Models, nickel-plated brass and cast iron, Berlin, circa 1882 (Photo, F.C. Moon)	300
12	High and low pressure valve mechanism for a steam engine. Schröder Model, Cornell University Collection of Kinematic Models, brass and cast iron, Darmstadt, Germany, circa 1870–1880 (Photo, F.C. Moon)	300
III.1a	Four-bar linkage: <i>Codex Madrid I</i> , Folio 1r	309
III.1b	Four-bar linkage: Reuleaux–Voigt Catalog, Model C-1 (Cornell Collection of Kinematic Mechanisms)	309
III.2a	Slider crank mechanism and worm drive: <i>Codex Madrid I</i> , Folio 28v (see also Folio 30r or 2r)	311
III.2b	Slider-crank mechanism: Reuleaux–Voigt Model, C-2 (Cornell Collection of Kinematic Mechanisms)	311
III.3a	Lazy tongs or Nürnberg shears: <i>Codex Madrid I</i> , Folio 24v	313
III.3b	Lazy tongs – parallel mechanism: Reuleaux–Voigt Catalog, Model T-2 (Cornell Collection of Kinematic Mechanisms)	313
III.4a	Gimbals mechanism: <i>Codex Madrid I</i> , Folio 13v	315
III.4b	Universal joint: Reuleaux–Voigt Catalog, Model P-1 (Cornell Collection of Kinematic Mechanisms)	315
III.5a	Belt and pulley mechanism: <i>Codex Madrid I</i> , Folio 23r	317
III.5b	Belt and pulley mechanism: Reuleaux Deutsches Museum Model, DM 06/6275 (c. 1880)	317

III.6a	Endless screw or worm drive: <i>Codex Madrid I</i> , Folio 17v	319
III.6b	Endless screw or worm drive: Reuleaux–Voigt Catalog, Model C-9 (Cornell Collection of Kinematic Mechanisms) . . .	319
III.7a	Screw jack: <i>Codex Madrid I</i> , Folio 26r	321
III.7b	Screw pair: Reuleaux–Voigt Catalog, Model A-1 (Cornell Collection of Kinematic Mechanisms)	321
III.8a	Double helix reversing mechanism: <i>Codex Madrid I</i> , Folio 15r	323
III.8b	Double helix reversing mechanism: Reuleaux–Voigt Catalog, Model M-6 (Cornell Collection of Kinematic Mechanisms) . .	323
III.9a	Pin-teeth rotary reversing mechanism: <i>Codex Madrid I</i> , Folio 17r	325
III.9b	Pin-teeth reversing mechanism: Reuleaux Model; Deutsches Museum DM 06/62/78 (c. 1880)	325
III.10a	Two intermittent mechanisms: <i>Codex Madrid I</i> , Folio 7r	327
III.10b	Intermittent mechanism – Geneva Wheel: Reuleaux–Voigt Catalog, Model N-8 (Cornell Collection of Kinematic Mechanisms)	327
III.11a	Ratchet and pawl mechanism: <i>Codex Madrid I</i> , Folio 117r . . .	329
III.11b	Ratchet and Pawl Mechanism: Reuleaux–Voigt Catalog, Model N-17 (Cornell Collection of Kinematic Mechanisms) . .	329
III.12a	Verge clock escapement: <i>Codex Madrid I</i> , Folio 115v	331
III.12b	Verge and balance wheel escapement: Reuleaux–Voigt Catalog, Model X-1 (Cornell Collection of Kinematic Mechanisms)	331
III.13a	Pinion and spur gear teeth: <i>Codex Madrid I</i> , Folio 5r	333
III.13b	Involute spur gear teeth: Reuleaux–Voigt Catalog, Model Q-2 (Cornell Collection of Kinematic Mechanisms)	333
III.14a	Single-sided rack and pinion: <i>Codex Madrid I</i> , Folio 35v	335
III.14b	Rack and pinion gear teeth: Reuleaux–Voigt Catalog, Model Q-1 (Cornell Collection of Kinematic Models)	335
III.15a	Planetary-epicyclic gear train: <i>Codex Madrid I</i> , Folio 13v	337
III.15b	Planetary-epicyclic gear train: Reuleaux–Voigt Catalog, Model G-2 (Cornell Collection of Kinematic Mechanisms) . . .	337
III.16a	Bevel gears: <i>Codex Madrid I</i> , Folio 96r	339
III.16b	Conical friction wheels: Reuleaux Model, Deutsches Museum (c. 1880)	339
III.17a	Friction wheels: <i>Codex Madrid I</i> , Folio 113v	341

III.17b	Variable-ratio, friction wheel clutch: Reuleaux–Voigt Catalog, Model Y-10 (Cornell Collection of Kinematic Mechanisms)	341
III.18a	Cam actuated lever: <i>Codex Madrid I</i> , Folio 6v	343
III.18b	Positive-return cam with Reuleaux triangle: Reuleaux–Voigt Catalog, Model L-2 (Cornell Collection of Kinematic Mechanisms)	343
III.19a	Water wheel: <i>Codex Madrid I</i> , Folio 142r	345
III.19b	Behrens–Dart pump and steam engine of 1867: Reuleaux–Voigt Catalog, Model I-7 (Cornell Collection of Kinematic Mechanisms)	345
III.20a	Flywheel designs: <i>Codex Madrid I</i> , Folio 114r	347
III.20b	Flywheel or balance wheel: Reuleaux–Voigt Catalog, Model N-27 (Cornell Collection of Kinematic Mechanisms).	347
IV.1	Theatre of Machines: Roberto Valturio (1472); Trebuchet siege machine	377
IV.2	Theatre of Machines: Vannuccio Biringuccio (1540); Water wheel driven bellows	379
IV.3	Theatre of Machines: Jacques Besson (1578); Nürnberg shears and pendulum driven pump	381
IV.4	Theatre of Machines: Jacobus de Strada (1617); Cover with images of Archimedes and Vitruvius	383
IV.5	Theatre of Machines: Vittorio Zonca (1607); Endless screw and winch	384
IV.6	Theatre of Machines: Georg Böckler (1661); Perpetual motion machine design	386
IV.7	Theatre of Machines: Phillipe De le Hire (1695); Three-tooth escapement	387
IV.8	Theatre of Machines: Jacob Leupold (1724); Windmill	388

List of Tables

I.1	Modern applications of kinematic mechanisms	19
I.1	(Continued)	20
I.2	Classification of Leonardo's machines by application	34
I.3	Reti's comparison of Leonardo's and Reuleaux's basic machine elements	43
I.4	Selection of machines cited in Franz Reuleaux's <i>The Constructor</i> ; 4th Edn (1893)	51
II.1	Machine artifacts in Aristotle's <i>mechanical problems</i>	109
II.2	Comparison of Francesco di Giorgio's and Reuleaux's basic machine elements	139
II.3	Comparison of Francesco di Giorgio's and Reuleaux's basic kinematic chain mechanisms	140
II.4	Theatre of machine books	147
II.5	Model collections of kinematic mechanisms	204
III.1	Catalog of Reuleaux kinematic models, Gustav Voigt Werkstatt, Berlin (1907)	305
III.2	Comparison of Kinematic Mechanisms in Leonardo's <i>Codex Madrid</i> with Reuleaux's Kinematic Models (KMODDL)	306
III.3	Comparison of Machine Elements in Leonardo's <i>Codex Madrid I</i> and in Reuleaux's <i>The Constructor</i> , 4th edition (1893)	307

PART I

Leonardo da Vinci and Franz Reuleaux: Machine Engineers



Leonardo da Vinci
[1452–1519]
Artist-Engineer

Franz Reuleaux
[1829–1905]
Engineer-Scientist

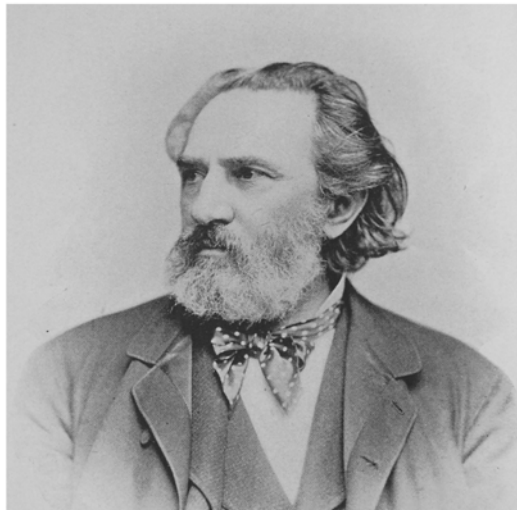

Leonardo da Vinci:

“Mathematical sciences are those which, through the senses, have a first degree of certainty. There are only 2 of them, of which the first is arithmetic, the second is geometry. One deals with discontinuous quantities, the other with continuous ones.”

[*Codex Madrid II*, Folio 67 recto; transl. L. Reti.]

Franz Reuleaux:

“A machine is a combination of resistant bodies so arranged that by their means the mechanical forces of nature can be compelled to do work accompanied by certain determinate motions.”

[*The Constructor*, 4th Ed., p. viii; transl. H.H. Suplee.]

Leonardo da Vinci and Franz Reuleaux: Machine Engineers

I.1 INTRODUCTION

The 21st century has been called the Information Age, a term that evokes images of cell phones, laptop computers, pagers and cell towers. Television and public flat panel screens in stadiums and airports confront us with flashing images, fantastic color shapes and ciphers offering information and visual promotions as if in some ethereal science fantasy world without need of energy or inertia. However behind the virtual worlds of the Internet, machines are still with us, often hidden behind shiny plastic and chrome or under the basement, closeted, silent and sentinel. Contrary to post millennium hype about the dominance of information technology, or IT, in the new millennium, our lives continue to be dependent on machines to transport us, cool and heat our homes, provide light and manufacture the very symbols of the IT Age.

There are of course machine aficionados such as clock collectors, motorcycle and car enthusiasts and children who love to play with LEGO® toy robots. But for most people, machines are hidden from their daily life. Machines are so reliable that we take them for granted, out of sight and out of mind unless they fail or some tragic plane or train crash forces us to face the reality of the world of energy and inertia. Some machine-based TV shows featuring flashy, chrome-built motorcycles have appeared recently and *Zen and the Art of Motorcycle Maintenance* has made a small comeback. But for the public and press the *Machine* has lost its power and symbolism in the postindustrial world. In addition, our knowledge of how and why machines work or what components they are made of has also declined in recent decades.

The complexity of modern technology is a hallmark of our age. We have created large networks for energy, communication and transportation that involve millions of components that seem to act as intelligent systems beyond

the capacity of the average human to contemplate. Machines are an important sub-class of these complex technologies. The Boeing 787 airliner for example is said to have over a million parts. The average automobile is made up of more than 20,000 parts and an office copy machine has over a 1000 parts counting all the miniature components of electronics in these devices. How did humankind learn to create, design and produce these complex technologies? It is a topic as important as the history of art or the history of the social and political milieu in which these technologies appeared.

This book is about our machines and their evolution over the centuries as seen through the lives of two engineers who became symbols of their own machine age, Leonardo da Vinci, an Italian artist-engineer of the Renaissance, and Franz Reuleaux, a German engineer-scientist of the late 19th century Industrial Revolution. It is a story of the beginnings of the scientific study of the machine, its codification into a language of invention and its deconstruction into basic machine elements. It is not a story of lone geniuses and machine inventors working in isolation. It is about the evolution of knowledge that originated in guilds and workshops, was handed down across the centuries in machine-books by artist-engineers and was finally liberated and promulgated through the use of mathematics and scientific principles.

The modern origins of the Machine Age of the 19th century began in the Renaissance in 15th century Italy. In Siena and Florence, artist-engineers such as Mariano Taccola, Francesco di Georgio Martini, and Leonardo da Vinci, produced collections of drawings of hundreds of machines and machine elements. Some drawings were published in book form as was the case of Taccola and Francesco di Georgio, while those of Leonardo remained in manuscript form well after his death. Leonardo's manuscripts were broken up and were subsequently dispersed throughout Europe. Some of the more famous Leonardo manuscripts that contain machines are the *Codex Atlanticus* in Milan, *Manuscript B* in Paris, and the *Codex Madrid I* in Madrid, Spain. The first two contain the famous drawings of flying machines. However the *Codex Madrid* is unique in that it marks the first attempt to deconstruct machines into basic machine elements or mechanisms or what Leonardo called 'elementi macchinali'. Had Leonardo actually published this work, it might have accelerated the development of machine design. Also the *Codex Madrid* with close to a 1000 drawings of machines and machine elements was lost for more than a century in the National Library of Spain and only rediscovered in 1965.

Recognition of Leonardo's work in science and technology emerged slowly at first through reproductions of his drawings in the early 19th century



Figure I.1. Portrait of Leonardo da Vinci [1452–1519]

and accelerated at the end of the 19th century with publication of facsimiles of the *Codex Atlanticus* in Milan and the Leonardo Notebooks in the Institute of France. As early as 1864, a few German engineers had access to the variety of mechanisms in Leonardo's drawings, one of whom was the famous 19th century mechanical engineer, Franz Reuleaux [1829–1905] of Berlin.

Shortly after the *Codex Madrid* was rediscovered in 1965, the da Vinci scholar Ladislao Reti translated the text into English and published several popular books on 'Leonardo the inventor'. He showed that da Vinci had attempted to compile a basic compendium of machine elements. To compare Leonardo's drawings of machine mechanisms with modern machine design books, Reti chose the list of machine elements proposed by Franz Reuleaux in his popular, 19th century book on machine design, *The Constructor*, first published in 1864 and translated into four languages and four editions. In the present book we have expanded on Reti's thesis that Leonardo had anticipated the codification of machine design in the 19th century. In the process



Figure I.2. Portrait of Franz Reuleaux [1829–1905]

we hope to evaluate the extent of Leonardo's influence on the education of late 19th century machine engineers.

One of our principal themes is that Leonardo da Vinci was a key node in a network of artist-architect-engineers, which passed on an unbroken chain of knowledge on the nature of machines through four centuries.

One of the fundamental questions of human evolution is how mankind learned to create the almost infinite variety of complex machines. Franz Reuleaux sought to address this question in his study of the theory of machines. The principles of design and building of machines was also a prime interest of the Renaissance engineers. Reuleaux raised a related question in 1885 on whether the capability to create complex technologies is more natural to certain races, ethnic groups or people from certain geographic areas. (Reuleaux's essay was a precursor to a contemporary book on a similar theme, *Guns Germs and Steel*, by Jared Diamond, 1999.) Reuleaux argued that the creation of an advanced technical society was not a matter of ethnicity but

depended on the commitment of that society to educate all its citizens on the truths of science and the process of rational thought. Leonardo in his time espoused a related theme, namely that the ability to invent new machines involved an experimental search for scientific truths and the use of mathematics to codify those truths.

In the last century we have witnessed the spread of the knowledge and ability to create complex technology to all cultures, races and geographic areas of the globe to the point that our new technical endeavors involve the entire human race. This transformation of creativity from the mind of an individual to a global collective technology has a long history that spans three or four millennia. Two important periods of technical history that witnessed a revolution in the process of creation of new technologies and in the creation of new machines in particular, were the Renaissance of the 15th and 16th centuries and the Industrial Age of the late 18th and 19th centuries.

The Machine Age of the 18th and 19th centuries marked the beginnings of the profession of mechanical engineering. Franz Reuleaux was one of the major theorists on the philosophy of machine design who taught in both Zurich and Berlin. He is credited with bringing order to the welter of inventions and hundreds of new machines that emerged in the industrial revolution by proposing that all machines are constructed of basic ‘*constructive elements*’ and basic ‘*kinematic chains*’. He enumerated six basic topologies of these machine elements, called kinematic mechanisms that determine the motions within machines; *crank chains*, *screw chains*, *wheel chains*, *pulley chains*, *ratchet* and *cam kinematic chains* as illustrated in Figure I.3.

In his famous book *Kinematics of Machinery* (1876), he also proposed a list of 22 building blocks of machines. In a companion book translated as *The Constructor* or ‘The Designer’ (1861–1893), he gave detailed formulas and figures on how to design each of these basic machine elements in this list (Figures I.4a and b). To complement these books Reuleaux designed and built 800 models of brass and iron as a museum of machine mechanisms in Berlin. He authorized several workshops to reproduce these models for teaching engineers and inventors and a number of sets of models were sold in Europe, North America and Japan (see Figure I.5). Many collections never survived the destruction of World War II including the original Berlin Collection. Approximately 60 models are in the Deutsches Museum in Munich, 113 models are in the University of Porto, Portugal and 230 models are in the Kinematic Mechanism Collection of Cornell University.

The beginnings of the deconstruction of machines into basic elements of machine design began in the Renaissance where parallels to Reuleaux’s for-

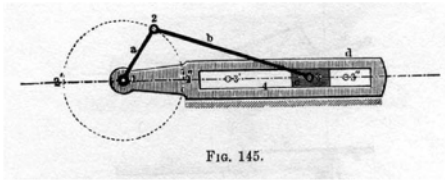

FIG. 145.

Crank Chain

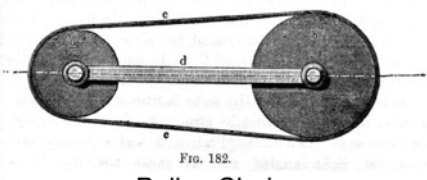

FIG. 182.

Pulley Chain

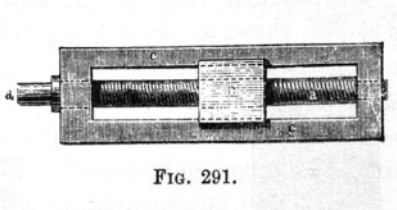

FIG. 291.

Screw Chain

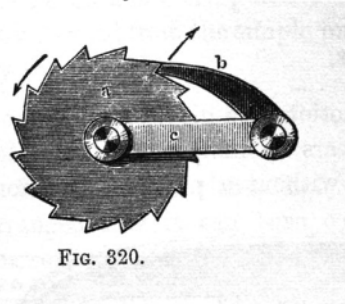

FIG. 320.

Ratchet Chain

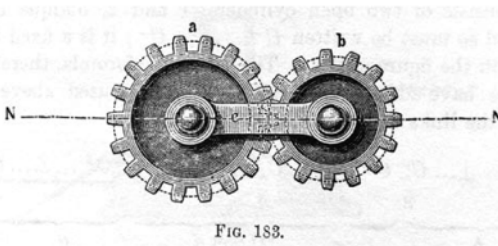

FIG. 183.

Wheel Chain

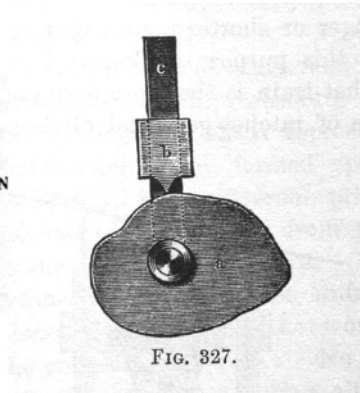

FIG. 327.

Cam Chain

Figure I.3. Reuleaux's six classes of kinematic mechanisms from *Kinematics of Machinery* (1876)

mal classification theory can be found in the drawings of Leonardo as shown in Figures I.4a and b. In this book we compare the variety of machine elements of the Industrial Age as codified in Reuleaux's models and books, with the known machine components of Leonardo's day. There is no claim that Leonardo da Vinci invented all or any of these components. There is reason to believe that many of the drawings simply recorded the devices produced in workshops in his time. Of course, it is likely that some of his combinations of mechanisms describing complete machines were true inventions of Leonardo. After his death, several picture books of machines were published

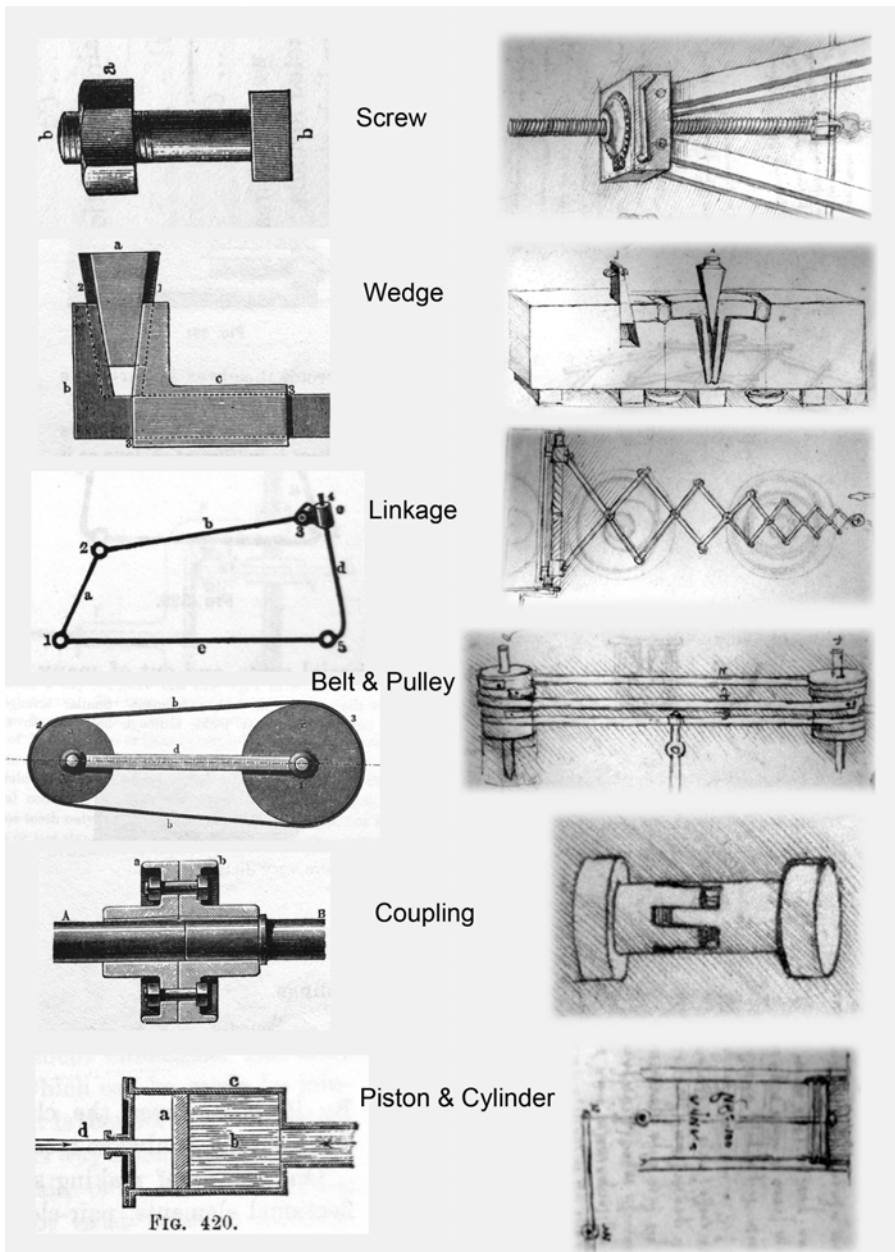

Figure I.4a. Comparison of kinematic elements in machine design from the books of Franz Reuleaux (on the left) and drawings of Leonardo da Vinci from the *Codex Madrid I* (on the right). See also Table I.3

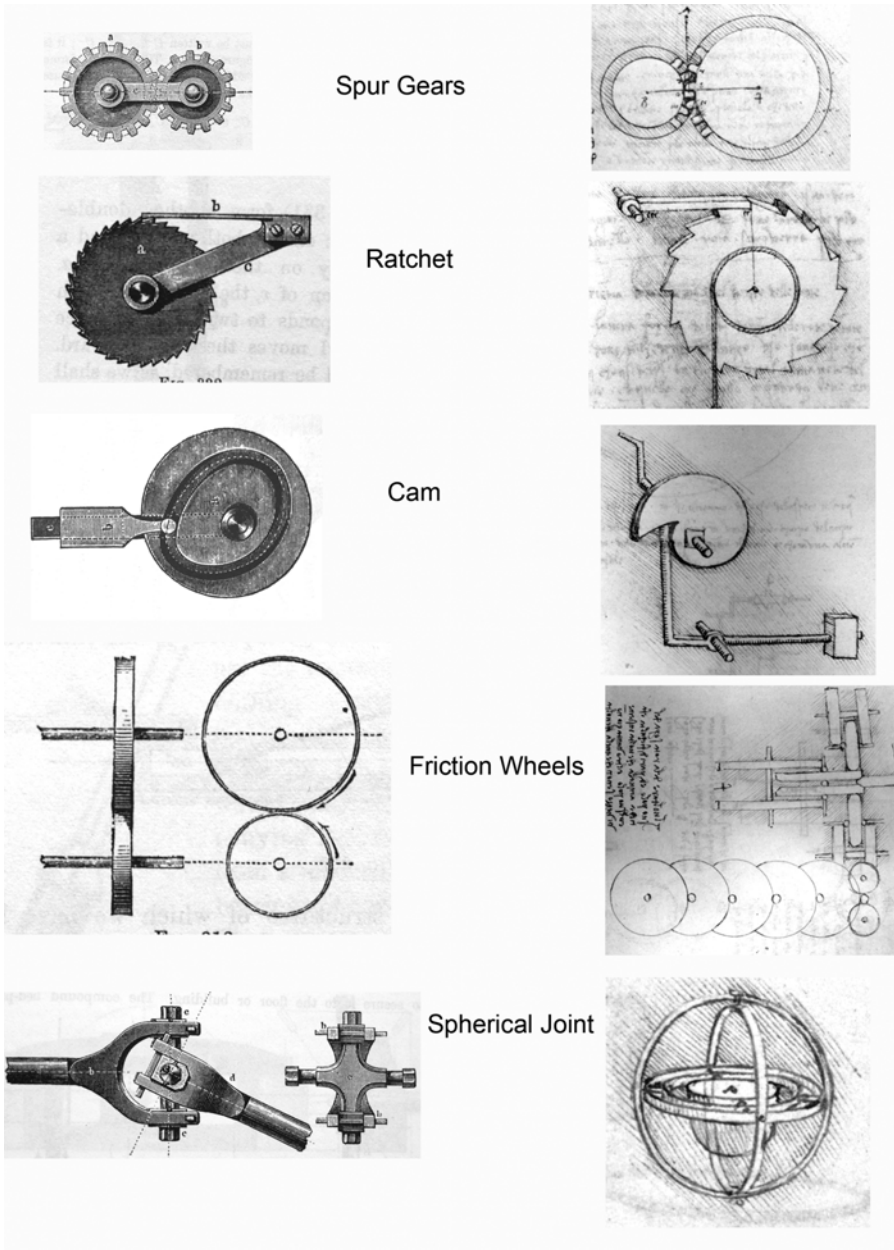

Figure I.4b. Comparison of kinematic elements in machine design from the books of Franz Reuleaux (on the left) and drawings of Leonardo da Vinci from the *Codex Madrid I* (on the right). See also Table I.3

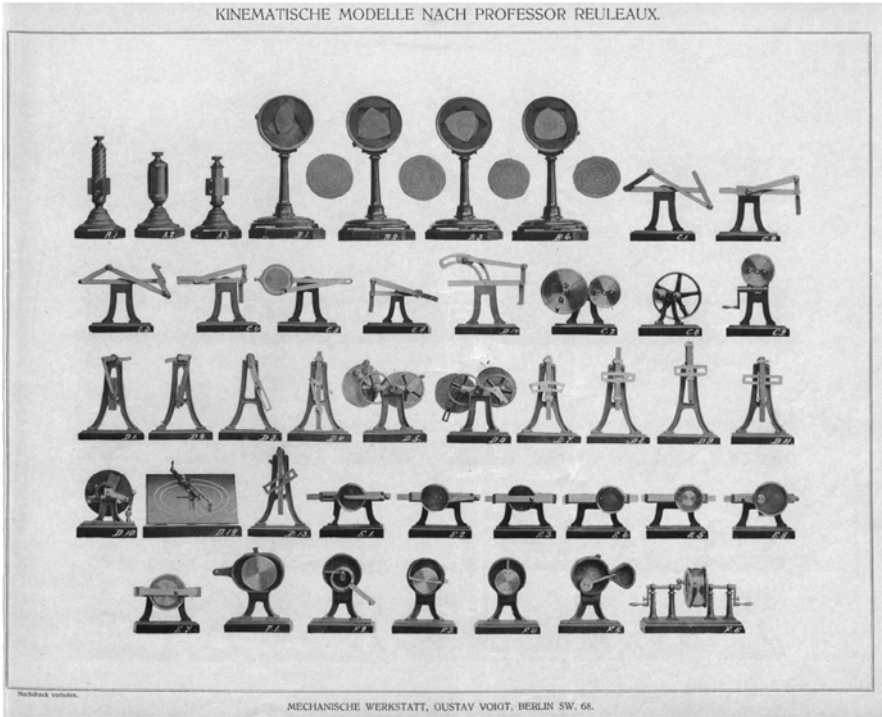

Figure I.5. Selection of 350 kinematic models from Voigt Catalog of Reuleaux Models (c. 1900)

such as that of Agostino Ramelli in 1588 called *Le diverse et artificieuses machine* (The Various and Ingenious Machines of Agostino Ramelli). Ramelli recorded complete machines employing many of the ‘elementi macchinali’ that appeared in Leonardo’s drawings, which Ramelli had not likely seen. It is highly probable that the bulk of the elements in both Leonardo and Ramelli’s works were common knowledge of craftspeople and machinists that had been handed down over the centuries with origins in Babylonian, Egyptian, Greek, Roman, Chinese and Arab civilizations that preceded the Renaissance revival of scientific and technical progress.

Late in his career, Franz Reuleaux (1884) edited a nine-volume, encyclopedic work called in English, *The Book of Inventions*, chronicling the history of technology. A forerunner of a later work by Singer et al. (1956), it begins the story of invention among primitive peoples and ancient civilizations and traces the path of technical progress into the machine age of the late 19th century. In a time when the hero-inventor paradigm was popular in the 19th

century American press, Reuleaux pursued the idea that it takes a society to produce a machine or any new technology.

The evolution of the process of technical creation is often ignored in conventional history books, explained sometimes in terms of individual genius-inventors and scientists. Careful study of the history of any technology such as clocks, computers, engines, or material processing will reveal a long path of evolution over many centuries, involving both the famous and not so famous inventors and craftspeople. In the creation of mechanical machines, this development was refined into a rational method that was codified in textbooks, design codes and in engineering societies. This codification enabled the diffusion of this methodology to all parts of the world. This was a remarkable achievement in the history of technology. This book will attempt to present a guide to a small part of this evolutionary path to the creation of technical complexity in our modern world.

In the frontispiece of Reuleaux's edited Volume VI, *Book of Inventions*, there is a beautiful lithograph showing the various components of machine design, gears, belts and pulleys, wheels and pistons, with an angel hovering and controlling the motions of these machine parts (Figure I.6). Both in Reuleaux's Industrial Age and the Renaissance, machines were often viewed in the same context as architecture and art and that the invention of new machines involved the same mindset and skills as that of the artist. This is another facet of comparison between Leonardo and Reuleaux that we will explore in this book.

OUTLINE OF THIS BOOK

This book consists of four parts; Part I, Sections 1–8, provide an introduction to the engineering careers of Leonardo da Vinci and Franz Reuleaux as well an assessment of the influence of the machine art of Leonardo on machine engineers and theorists in the Industrial Age of the 19th century. Part I also has a brief introduction to kinematics of machines and mechanisms for the reader not familiar with this subject.

Part II, Sections 1–21, consists of a survey of the evolution of machines and their design methodology from the time of the Renaissance to the beginning of the 20th century. We discuss the roles of mathematics, mechanics and art in the process of machine invention and design and try to understand Leonardo's methodology as a machine engineer. We posit a list of five essential factors in the invention of a successful machine and review how these conditions were met in the development of the Watt–Boulton steam engines

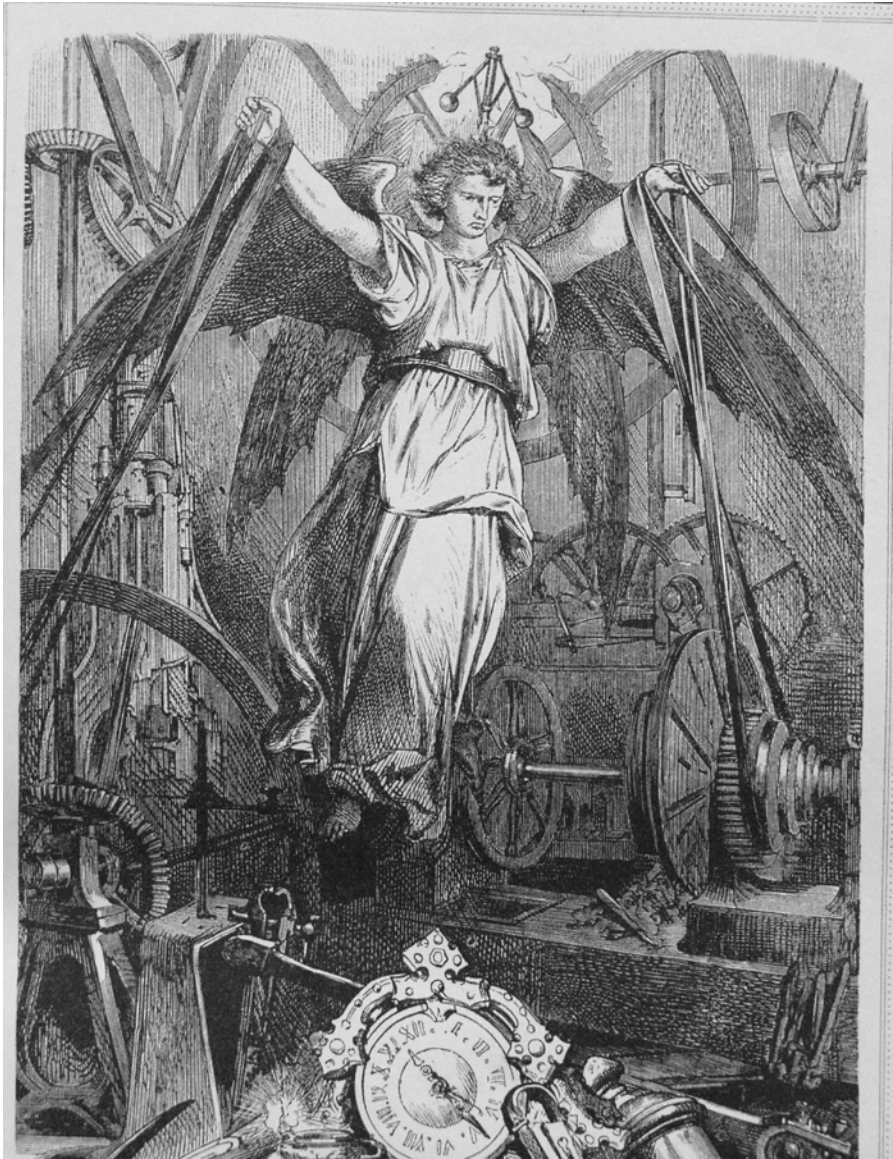

Figure I.6. The Angel of Machines: from *Buch der Erfindungen Gewerbe und Industrien*, or Book of Inventions, Vol. 6, 1887, F. Reuleaux, Editor

of the late 18th century. We end Part II with a discussion of machines, robots and biology and the early development of flying machines.

Part III is a kinematics mechanism reference section, containing detailed comparisons between the machine drawings of Leonardo da Vinci and the kinematic models of Franz Reuleaux.

Part IV has the usual list of cited references but also contains lists of texts on Leonardo da Vinci, kinematics and the work of Franz Reuleaux and his school of machine theorists. The Appendices in Part IV contain a valuable summary of 'Theatre of Machines' books from the 15th to the 19th century. This section also contains a set of problems and projects for students and instructors of design and history of engineering courses.

Parts I and II were written so that sections could be read or assigned for study in a somewhat random order. The author hopes that the serial reader will not be too critical of a certain amount of redundancy in the background information.

I.2 MODERN APPLICATIONS OF KINEMATICS: LEONARDO IN YOUR TOOTHBRUSH

The current era of technology has been called the microelectronics, and nanotechnology revolution. Contemporary high technology is identified with computers, cell phones and other communication devices. Macro-technology, in the form of high-speed trains such as the 240 km/h (150 mph) Acela Amtrak machines in the US, and the 430 km/h (269 mph) German-Chinese Transrapid MagLev train in Shanghai or the Boeing 787 and the Airbus 380, the largest airliner in the world that will enter service in 2007, are almost invisible in the media. Machines today are taken for granted even though we all ride in cars or planes, brush our teeth with them and copy and print our documents with machines (see e.g. Table I.1). Thus it is hard to imagine the excitement that machine technology produced in the 19th century.

The American celebration of the Machine took place at the Centennial Exposition in 1876 in Philadelphia. The centerpiece of this world's fair was the grand Machinery Hall with its hundreds of machines on display including the largest steam engine in the world, the Corliss Engine. President Ulysses S. Grant was on hand to turn the valve that started the huge engine and power the rest of the machines through a network of moving belts and pulleys. Over seven million people attended the Philadelphia world's fair in six months, an astounding figure in an age without automobiles. Such was the attraction of technology and machines a century ago. Though many Americans spend more each year on new sport utility vehicles than on personal computers, the news about these new vehicles is often on the global positioning (GPS) map system and the on-board portable video for the children than about any new mechanical technology, let alone the mechanisms that comprise the heart of the machine.

Modern consumer packaging has largely placed the technological nucleus of machines out of sight. This is especially true of the set of mechanisms that are linked together to make the machine transform energy into useful applications. Yet mechanisms and the science of kinematics upon which the design of these devices depends are very much at the heart of many of the modern technologies that we shall review in this section. Beginning in the time of Leonardo da Vinci, and culminating in the work of Franz Reuleaux in the 19th century, engineers were able to view the construction of machines as a set of interconnected modular elements called 'constructive elements' by Reuleaux or 'elementi macchinali' by Leonardo.

An important contribution of Reuleaux was the recognition that mechanisms in machines consist of a kinematic chain of simpler elements. A kine-

matic mechanism is one in which the motion of one element determines the motion of all the other parts. Thus in a child's tricycle the motion of the pedal crank determines the rotation speed of the three wheels and the forward speed of the tricycle. The interrelationship between the motions of all the parts is determined by the geometric constraints between the parts, such as the size of the pedal and the diameter of the wheels. Any machine can be deconstructed into sets of basic mechanisms in the same way that a sentence is the sum of words with grammatical relationships. Reuleaux developed a language of symbols for this deconstruction of machines in the hope that it would help in the invention of new machines. In the newly discovered *Codex Madrid* of Leonardo, there is evidence that da Vinci had planned to set down a basic set of mechanisms through the use of technical drawings, which could be used by engineers and designers to construct new machines. Unfortunately like many of his unfinished projects, Leonardo never published such a book and his notebooks with these drawings were scattered in private and Royal Libraries and some were lost for many centuries.

In the Renaissance, the principal applications of machines were for warfare, construction, canal digging, water pumps, clocks as well as water wheels for transmitting energy and machines for producing textiles as illustrated in the notebooks of Leonardo da Vinci. In Reuleaux's time, the steam engine was replacing water as a prime mover and the applications ranged from pumping water out of deep mines, blowers for iron production, railroad engines, steam ships, as well as agricultural and production machines in the 19th century. At the same time mechanisms began to be employed for calculating machines, thus anticipating the age of computers.

In the current age, mechanisms and the theory of kinematics find application in another set of technologies that did not exist in Reuleaux's time. These include automobiles, aircraft, space vehicles, robots, assembly line manufacturing as well as in electronic printers and cameras. And as illustrated in Figures I.7 and I.8, modern mechanisms can be found at either a scale of meters or micrometers.

In the 'information age', a new era of machine design has emerged called '*mechatronics*', which combines the three fields of machine design, electronic control and artificial intelligence and computer science. In the new era of mechanical design, mechanical components of high strength and endurance are still required to run at high speeds and carry high torques, but many of the control linkages found in 19th century machines are now replaced with electromagnetic and optical sensors and the prime movers are often electromagnetic motors. In contrast to early 20th century control in machines, analog



Figure I.7. Landing gear linkage for an Airbus jet. (Science Museum, London)

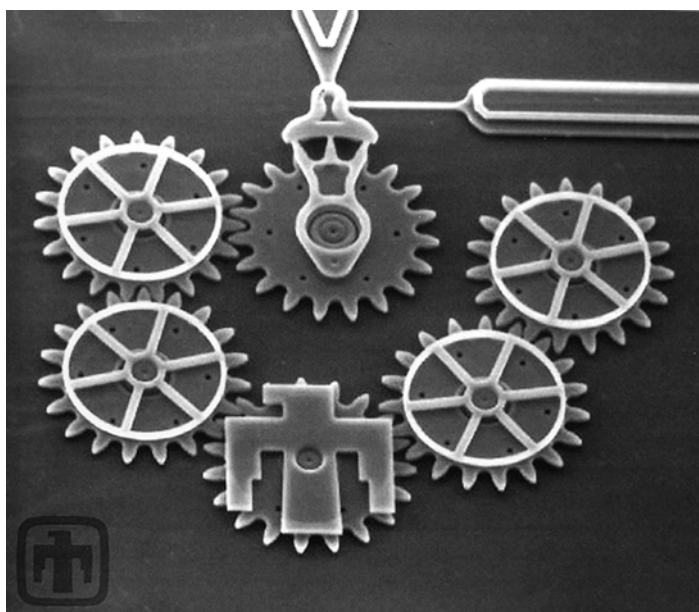

Figure I.8. Micro-electromechanical System [MEMS] gear train; Courtesy: Sandia National Laboratory

controllers have largely been replaced by digital electronics and associated microprocessor computer control. Modern robotic machines are often characterized in the media as emanating from computer technology. However key

components in robots such as the topology of the linkage, joints and end effectors are derived from the field of mechanism design.

There are thousands of modern applications of kinematic mechanisms, many of whose basic elements were known at the time of Leonardo da Vinci. Reuleaux and other machine engineers later codified these mechanisms, using mathematical principles in the 19th century.

From the Renaissance to the Industrial Age, machines were largely constructed from assemblies of fairly rigid objects such as gears, cams, screws, links and pistons with some use of flexible elements such as belts and springs. Today modern kinematic mechanisms can be made entirely of compliant elements, so much so that the line between machine and structure has become blurred. Also as illustrated in the gear array in Figure I.8, micro-electromechanical systems or MEMS are using kinematic elements on a scale of microns, many of which use compliant mechanisms. At a much smaller scale of nanometers, molecular arrangements of molecules are being synthesized to function as kinematic mechanisms with screw and rotary motions.

Whether the scale is 1–10 meters as in the landing gear of jetliners (Figure I.7) or at the submicron level of molecular machines, the key design guideline of machine invention and creation is ‘*geometry and topology rules*’. Machines transform motion and in doing so transmit forces, energy and information. And although physical laws are essential to their operation, the geometric arrangement of machine elements is key to how successful this transformation of motion is. As we shall see throughout this book, geometric thinking was key to the design of machines for both Leonardo da Vinci and Franz Reuleaux.

Our final thought in this discussion of modern applications of kinematics is the roles that energy-based machines and information-based machines played in the evolution of technology. Throughout the period from the 15th to the 20th century, both types of machines were developed. Beginning in the 16th and 17th centuries, clocks and automata required the development of precision manufacturing to create accurate gearing and linkages, especially in digital devices such as clocks, calculators and arithmometers that later appeared in the 19th century. In the development of power machinery, especially internal combustion machines in the middle to late 19th century, the need to develop strong materials to resist high stresses and high temperatures pushed the development of materials engineering. Both technologies of precision fabrication and advanced materials came together in the aeronautical engines of the 20th century as well as in the information processing technologies of the early computer age. Most of the data storage of the late 20th and early 21st

Table I.1. Modern applications of kinematic mechanisms

Automobiles
Engine components: pistons, crankshaft, cams, valves
Gear transmission: planetary gears
Rear axel: universal joint and differential, ball bearings
Brake system
Doors, hatches, hood
Aircraft
Fuselage: passenger and cargo doors and hatches
Landing gears
Wings: flaps, control surfaces, ailerons
Engine: bearings, gearing
Robotics
Manipulator arm linkage
End effector, grippers
Hydraulic actuators, pistons and valves
Bio-engineering
Artificial limbs: linkages and cable systems
Artificial hands
Joint replacements: bearings
Mobile chairs: wheels, brakes
Space Technology
Spacecraft antenna: folded structures
Nose cone shroud
Solar panels
Planetary rover vehicles
Space shuttle robotic arm
Manufacturing
Machine tools: lathes, milling centers
Assembly line components
Machining centers
Textile production machines
Electronics and Computer Technology
Cameras: lens focus mechanism
Disc drives, microdrives
Video recording and playback devices
Computer printers: belt drive mechanisms

Table I.1. Continued

Food Production
Farm machinery: plowing, seeding, harvesting
Crop picking machines
Food packaging and bottling machines
Construction Machines
Cranes: pulleys, cables
Backhoes, loaders
Cement mixing machines
Tunnel boring machines

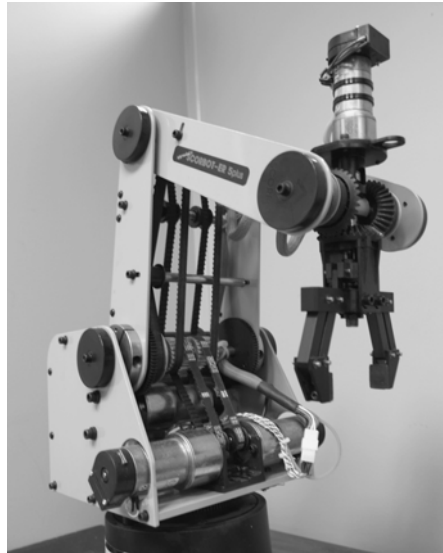

Figure I.9. Modern robotic manipulator arm with end effector gripper

century is on rotating disc machines in which the read-write head rides above the surface at less than a micron. The modern creation of machines spans not only a wide range of applications (listed in Table I.1), but a wide spectrum of scales from 10 to 10^{-9} meters and a wide spectrum of energy densities.

LEONARDO IN YOUR TOOTHBRUSH: KINEMATIC MECHANISMS IN DAILY LIFE

Two popular products are the ‘Spin-Brush’ or motorized toothbrush and the ‘iPOD’. In the latter, wires in listeners ears lead to a small box with an electronic chip that stores music from the web sometimes on a micro hard disc.

The ‘iPOD’ is an icon of 21st century information technology. In contrast are the wireless, motorized toothbrushes initially costing \$30–50 that can now be bought for a few dollars or euros. Some of these dental devices also embody modern mechatronics and electronic chips, but most possess kinematic mechanisms that have roots in the Italian Renaissance 1450–1600.

An example of one of the first motorized toothbrushes is the upscale model by the German company Braun, circa 2001, shown in Figure I.10a. This is a marvel of miniature *mechatronic* design. The brush sits in a holder (not shown) that picks up electrical power from an alternating voltage outlet in the wall. A coil in the brush converts the ac power to dc current that charges the batteries using an electronic circuit board in the handle. This is the ‘-tronic’ part of the *mecha-tronic* machine. The battery drives a small continuous speed electric motor. The goal of the machine design is to convert the motor motion into oscillating motion in the small brush at the end that cleans your teeth. The mechanical parts consist of three kinematic mechanisms:

- (i) a brass gear-pinion mechanism;
- (ii) a four-bar linkage;
- (iii) a three-dimensional ball joint mechanism.

These mechanisms produce the following change of motions in your toothbrush:

- (I) change of high speed continuous rotation into lower speed rotation;
- (II) the crank in the four-bar linkage converts continuous rotary motion into oscillating motion in the follower link;
- (III) the three-dimensional ball linkage converts oscillating motion about the vertical axis in the handle into oscillating motion about a transverse axis that ‘spins’ the brush; the final motion that helps clean the teeth.

Another dental product that costs much less than the 2001 Braun is the Crest ‘*Spin Brush Pro*’ shown in Figure I.10b. Here there is no on-board rechargeable circuit: just a AA battery. In this device there are also three kinematic mechanisms:

- (i) a plastic crown wheel gear and pinion mechanism;
- (ii) a slider-crank mechanism with the crank and the drive link;
- (iii) another slider-crank mechanism with the slider and the drive link.

These mechanisms provide the following change of motions in your toothbrush:

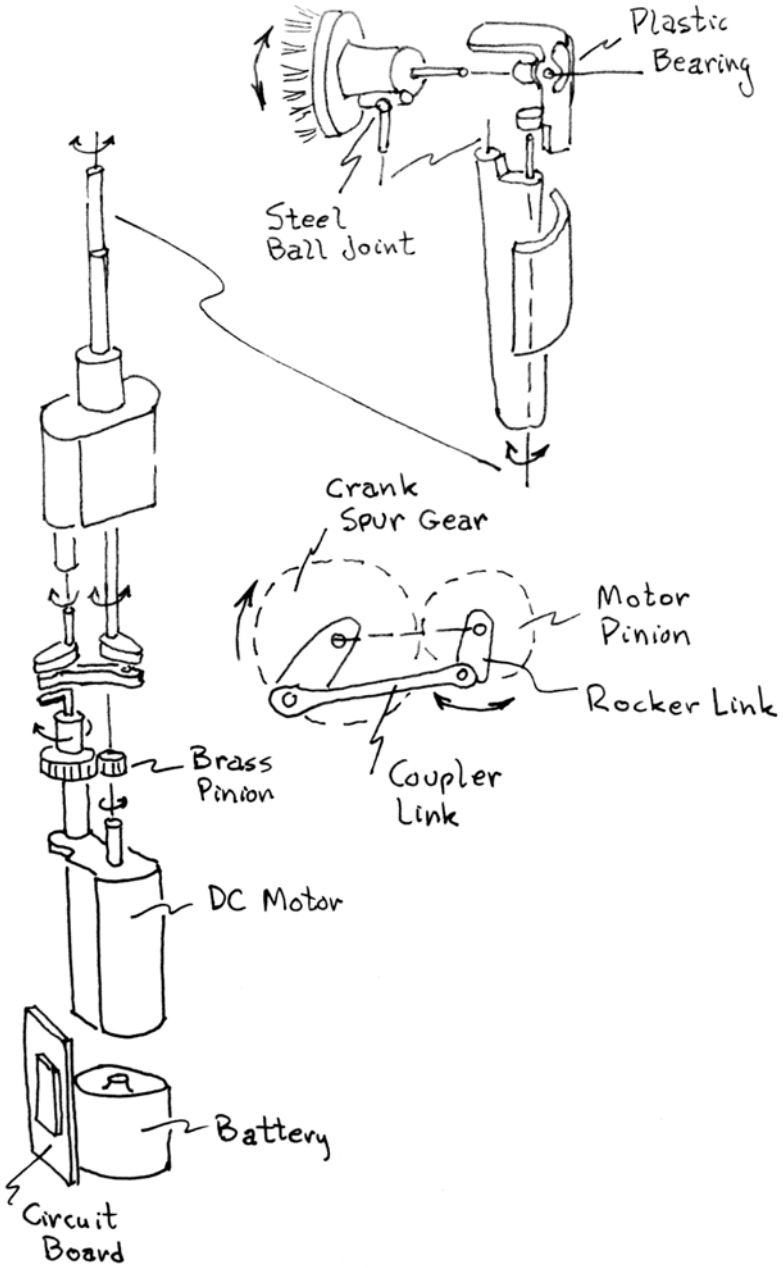

Figure I.10a. Sketch of the mechanisms in a modern electronic toothbrush: Braun Model

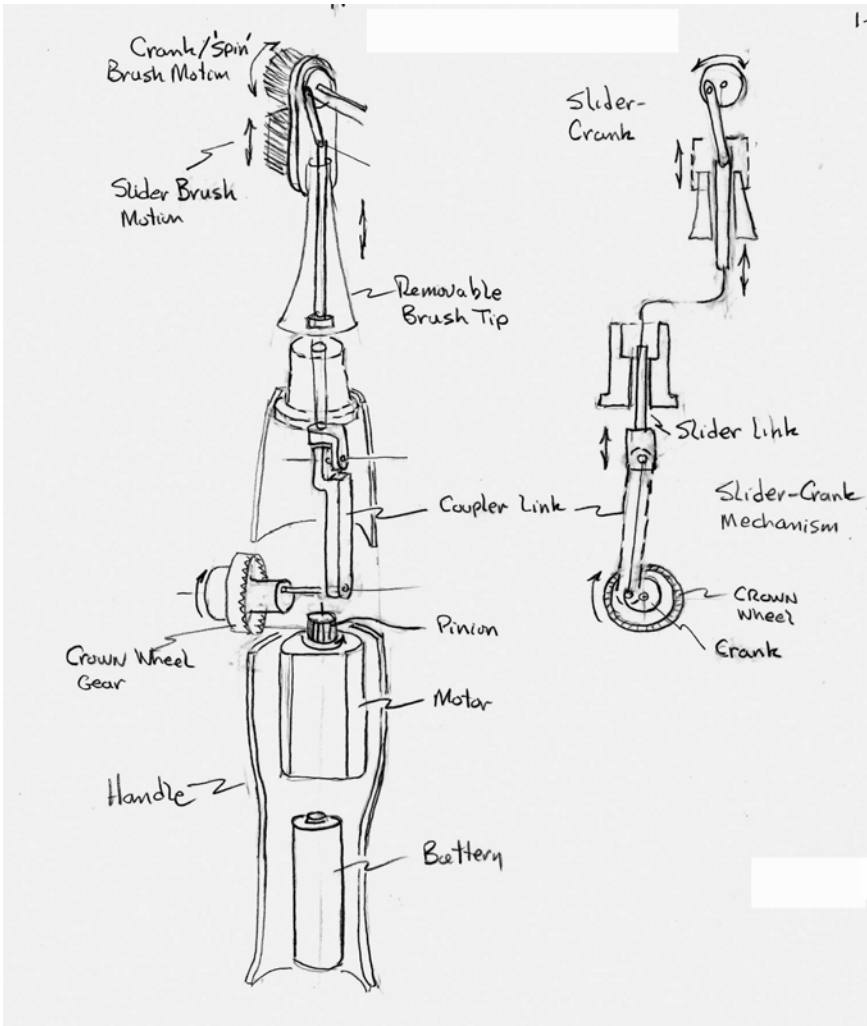

Figure I.10b. Sketch of the mechanism in a motorized toothbrush: Colgate Model

- (I) the crown-wheel and pinion change high-speed motor rotation about the vertical axis into lower-speed motion about a transverse axis;
- (II) the crank in the slider crank mechanism converts continuous rotary motion into oscillating motion of the slider along the vertical axis;
- (III) the upper slider-crank converts the oscillating motion of the slider into oscillating motion of the brush.

It should be noted that the brush is really oscillating about a horizontal axis and is not spinning with constant speed, as the name would imply.

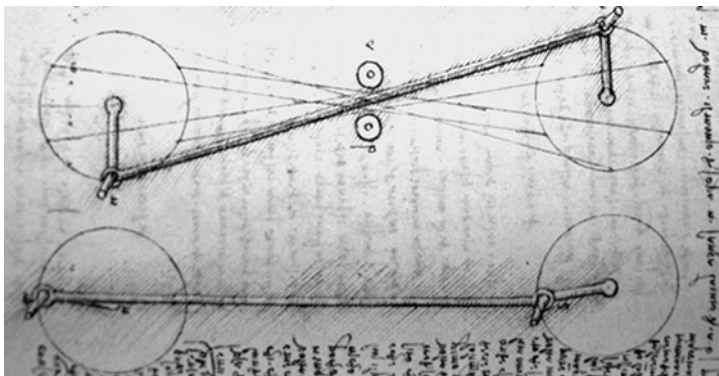

Figure I.11a. Four-link mechanism of Leonardo da Vinci (*Codex Madrid I*)

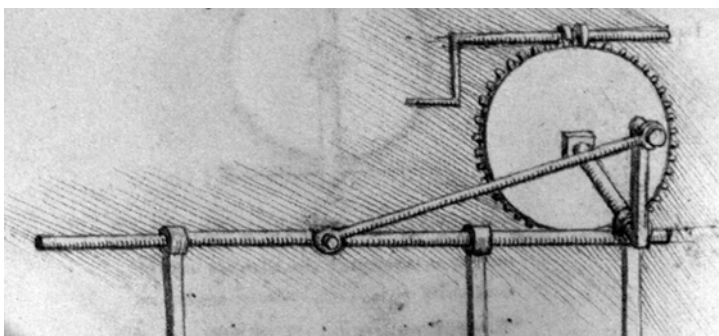

Figure I.11b. Slider-crank mechanism (*Codex Madrid I*)

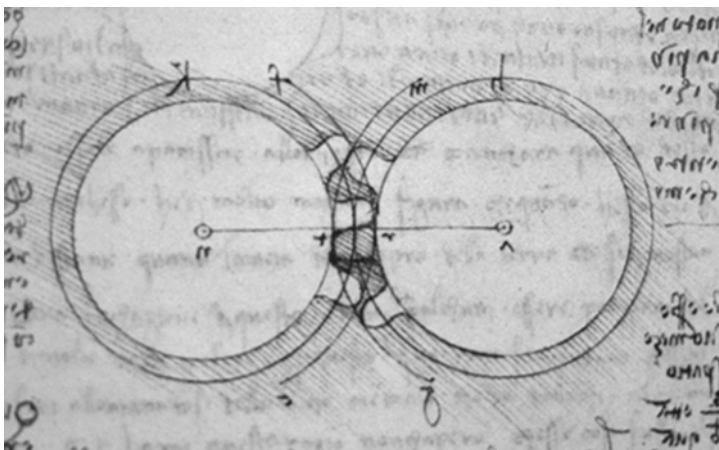

Figure I.11c. Gear and pinion (*Codex Madrid I*)

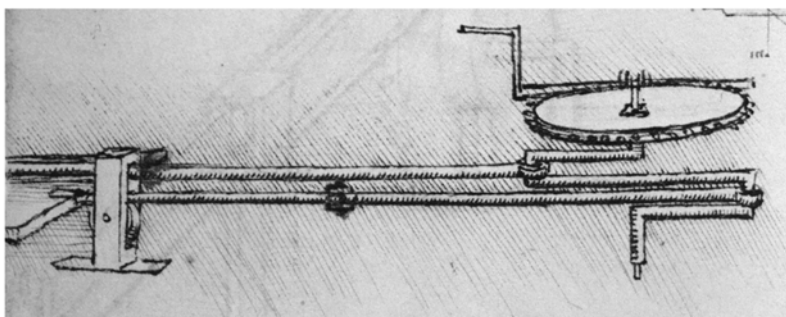
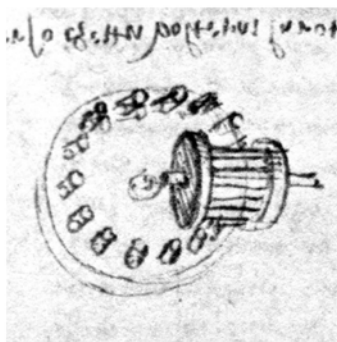
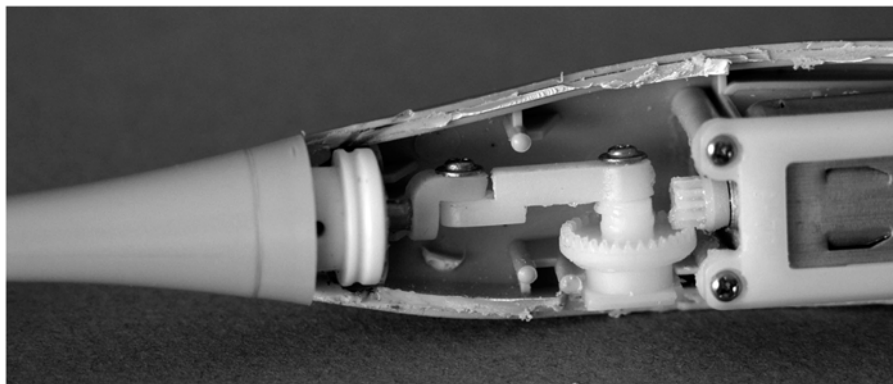

Figure I.12. Top: toothbrush with crown wheel gear and pinion and slider-crank mechanism. Middle: Crown wheel gear and lantern pinion of Leonardo da Vinci from the *Codex Madrid I*. Bottom: Double slider-crank mechanism and worm gear drive of Leonardo da Vinci from the *Codex Madrid I*

Although several manufacturers have secured patents on these devices, the sub-mechanisms that change the constant rotary motion of the motor into the oscillating brush motion can all be found in the machine books of the Re-

naissance notably in the drawings of Leonardo da Vinci. Two of the principal manuscripts with drawings of machines and mechanisms are the *Codex Atlanticus* in the Ambrosiana Library in Milan, Italy and the *Codex Madrid* in Spain. In these manuscripts one can find hundreds of drawings of machines, geometric exercises, architectural designs and textural descriptions and notes intermingled with the drawings. Although Leonardo's writings were thought by some scholars to have been designed for formal books on painting, machine design or bird flight, what survives is more or less the first sketches, ideas and musings of one of the principal icons of the Renaissance man.

There are many drawings of Leonardo of complete machines. But there are many other drawings of machine components that are used in all machines. In Leonardo's machine elements the focus is often on how the mechanism converts motion from one form to another as from continuous rotation of a water wheel into oscillating motion in a linkage in a textile machine.

The geometric principle of conversion of motion from one form to another, without regard to the forces, is called *kinematics* or the study of pure motion. This name was given by the French mathematician, A.M. Ampere, in the early 19th century.

Several of the toothbrush mechanisms can be seen in Leonardo's drawings from his *Codex Madrid I* as shown in Figures I.11. In Figure I.11a is a drawing of a four-bar mechanism and Figure I.11b shows a slider crank device. Another drawing is a pinion-gear pair (Figure I.11c) similar to the pair in the toothbrush shown in Figure I.10a. The difference between the two gear pairs in Figures I.10a and b is that the axes of rotation of the pinion-gear set are parallel in contrast to the crown wheel-pinion gears the axes of rotation are at an angle of 90 degrees to each other.

A motorized toothbrush with a slider-crank and crown wheel gear is shown in Figure I.12. Leonardo's drawings corresponding to these toothbrush mechanisms are also shown in Figure I.12.

I.3 DECONSTRUCTING THE MACHINE: CONSTRUCTIVE ELEMENTS OF DESIGN

The evolution of machine theory has some similarity with biology. By the middle of the 19th century, machines had been invented and built that had their own sources of energy, were mobile, and were undergoing a process of multiplication and evolution, becoming more complex with every new generation. To bring order to the welter of new machines, engineers began to search for ways to codify and classify these devices. Beginning in the 16th century, compendia of machines, such as those of Besson (1578) and Ramelli (1588), organized machines according to application, such as pumps, manufacturing machines, construction machines, etc. This methodology paralleled similar attempts to organize the biological world such as the *Systema Naturae* of Carolus Linnaeus in 1735.

Beginning in the 18th century, with Leupold (1724) and the French Ecole Polytechnique in Paris, another theoretical path to machine theory was opened that attempted to organize machines from a reductionist point of view based on modular elements. The *Codex Madrid* of Leonardo da Vinci provides evidence that Leonardo envisioned a similar deconstruction of complex machines into basic machine elements in the late 15th century. By the 19th century however, mechanisms began to be viewed as *motion-changing devices* and this path was formally codified by Charles Babbage of computer fame, Robert Willis of Cambridge and later by Franz Reuleaux. Reuleaux introduced ideas based on kinematic pairs, kinematic chains, and compound mechanisms. Other codifiers of machine systems however included *prime movers* and *automata*. In recent years new terminology have appeared to deal with the inclusion of electronics and computers into mechanical devices with terms such as smart machines, mechatronics and micro-electromechanical systems or MEMS.

The codification of machine design has been taken for granted in the history of technology. The creation and design of machines on a rational basis freed the industrial age from the secrecy of the guild and workshop and helped to diffuse this knowledge all over the world, changing once feudal societies like Japan into emerging industrial powers by the end of the 19th century.

To help in our discussion of the theory of machines we present a short list of concepts to be used in this book.

CONSTRUCTIVE ELEMENTS OF MACHINE DESIGN

When many different machines are disassembled into their constituent parts, there is a surprising similarity in the types of parts common to different machines even though the machines have entirely different applications. Most machines have rotating parts such as shafts, bearings and bearing supports. Others have belts, chains and gears to transmit motion from one part of the machine to another. An example of the deconstruction of a machine is the first automobile of Carl Benz, 1885 shown in Figure I.13. Benz was trained at the Karlsruhe Polytechnique in Germany under Ferdinand Redtenbacher, the same professor of mechanical engineering under whom Reuleaux studied.

Although machine builders knew of many machine elements by the 18th century, Reuleaux attempted to summarize the basic set of elements common to most machines of his time and organized them according to geometric principles. This list appeared in his *Kinematics of Machinery*, (1875–1876), and also in his earlier *Der Constructor* (The Designer) (1861–1893). These ‘*constructive elements*’, as Reuleaux called them, had been anticipated by Leonardo da Vinci, mainly in his unpublished *Codex Madrid*. Machine elements appear today in standard machine design textbooks and many have been modularized in subcomponent catalogs of manufacturers in the form of bearings, gearing, motors, etc. In Reuleaux’s list of constructive elements are included both kinematic and load bearing elements. Gears for example represent kinematic elements whose principal role is to change and transmit motion, while shafts, axels and bearing pedestals are required to support loads, forces and torques in the machine.

SIMPLE MACHINES

The ancient Greeks defined six types of so-called simple machines: the *lever*, *wedge*, *screw*, *pulley*, *wheel and axle*, *winch and inclined plane*. These machine elements were often viewed in terms of equilibrating and transforming forces. In Franz Reuleaux’s classification however, the ‘simple machines’ are each kinematic pairs designed to change motion through geometric constraints. This new view of mechanisms, in terms of constraints, changed the way engineers viewed the design of complex machines in the late 19th century. The so-called ‘simple machines’ evolved when human effort was the major prime mover. Given the force limitation on a human worker, the simple machine such as the lever enabled the low force and large motion of the human to be transformed into the small motion and large force of lifting heavy objects such as stone for construction projects. With the evolution of water mills, windmills and steam engine mine pumps, the focus of machines

**Deconstructing Carl Benz's First Automobile of 1885
Into Reuleaux's Machine Elements**



- Friction Wheels
- Chain Drive



- Belt Drive and Shifter
- Bevel Gears
- Cam Mechanism
- Valve Linkage
- Slider Crank Linkage
- Piston and Cylinder
- Flywheel

Figure I.13. First automobile of Carl Benz and the list of basic machine elements and mechanisms (c. 1885) (Courtesy of the Deutsches Museum, Munich)

shifted to the transformation of motion. Beginning with the French mechanicians of the Ecole Polytechnique in the late 18th century, the complex nature of the rotating, translating, alternating and ratcheting motions began to take equal importance with the forces and strength of materials issues in machines. This trend can also be seen in the drawings of Leonardo da Vinci's notebooks

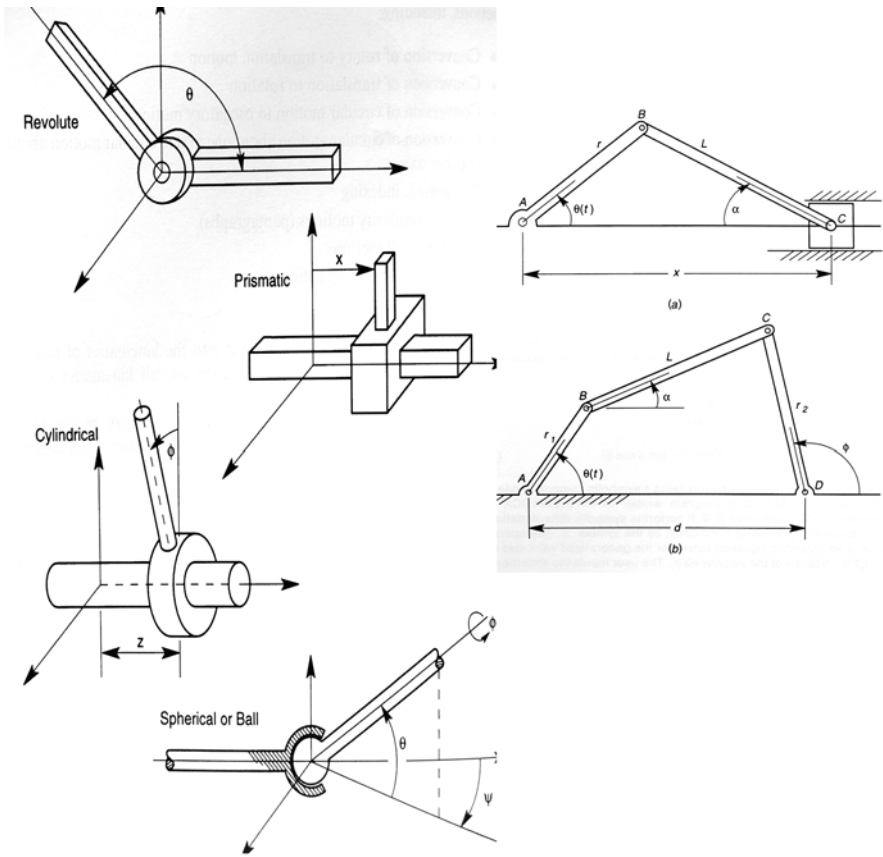

Figure I.14. Left: kinematic pairs; Right: (a) slider crank and (b) four-bar kinematic chains

that show his passion for the almost infinite topological variety of motion-changing mechanisms possible in complex machines.

KINEMATIC PAIRS

Reuleaux defined the constrained motion between two neighboring parts in a machine a *kinematic pair*, such as a piston in a cylinder of an internal combustion engine. (Figure I.14) These two parts can translate relative to one another called a *prismatic joint*. Two links connected by a pin joint on the other hand can only rotate with respect to each other in a *revolute joint*. A screw and a nut move in a helical motion relative to each other in a *screw joint*. Reuleaux called joints with surface contact such as a cylindrical bearing a *lower pair* constraint and he called joints with point or line contact a *higher pair* con-

straint. Several sets of linked kinematic pairs form the basis of a higher level concept in a machine called a *kinematic chain*.

KINEMATIC CHAIN

A kinematic chain is a connected series of kinematic pairs that form a closed loop or circuit, similar to an electrical circuit (Figure I.14). A bicycle chain is a set of cylindrical pairs or *revolute joints*. The closed loop of a crankshaft, piston rod, cylinder and cylinder block form one of the most ubiquitous kinematic chains found in all internal combustion machines called a *slider-crank chain* (Figure I.14a). The key property of the kinematic chain is the fact that the motion of one or more of the pairs in the chain, determines the motion of the parts in the rest of the chain. This places the design of mechanisms in the realm of geometry and mathematics.

MECHANISMS

Mechanisms are simple or compound kinematic chains which are designed to transform motion. The motion of one link or element in the mechanism determines the type of motion in the rest of the links in the kinematic chain. For example, the slider crank kinematic chain in an internal combustion engine, i.e. the crank, piston and cylinder and connecting rod, changes the translation motion of the pistons into rotary motion of the crankshaft. In the early 19th century French school of kinematic design, mechanisms were classified as to how they changed motion; from say rotary into translation or from alternating into rotary motions. In 1826, Charles Babbage of England tried to develop a '*mechanical notation*' for mechanisms based on the transformation of motions in the machine.

COMPLEX MACHINES

Several mechanisms coupled together, along with a source of motion or energy, form complex machines. An example is the first automobile of Benz (1885) shown in Figure I.13. It consists of several kinematic pairs (i.e. piston and cylinder block, or bevel gear pair) and coupled kinematic chains (e.g. the slider-crank formed by the piston or the chain drive coupled to the friction wheels on the ground), along with the chemical reactions of the fuel-air mixture that provide the force to drive the piston. In a mechanical clock however, the energy source is either gravity or an elastic spring and the motion is modified kinematically (i.e. geometric constraints) by a set of gears and often a ratchet wheel called an escapement.

PRIME MOVERS OR ENGINES

Prime mover machines are sometimes referred to as ‘engines’ as in gas turbine engines or internal combustion engines. From the 14th to 18th centuries, water power was a dominant adjunct to machines. Wind power in Europe had its origins in the late 13th century, especially in the region that is today Holland. Beginning in the 18th century and accelerating in the 19th century, the steam engine replaced windmill and water mill prime movers. By the 20th century, the steam turbine and electric motor had almost eliminated the reciprocating steam engine as a major prime mover. Franz Reuleaux played a role in the development of the Otto internal combustion engine of 1867 and one of his fellow alumni of Karlsruhe University, Karl Benz demonstrated its application in automobiles in 1885, a use that continues more than an century later. Electromagnetic motors of all forms, based on magnetic forces as well as actuation using hydraulic actuators have become principal drivers of many small to medium machines including robotic devices. In contemporary MEMS machines, micro-electric actuation based on direct electric forces finds application in acceleration sensors in automobile air bags.

AUTOMATA

The automated machine has a connotation of performing its tasks without human intervention according to an embedded set of instructions. Water driven automata were mentioned in ancient Greek literature as well as in Arab books describing machines of the 13th century. Before the industrial age *automata* devices were identified with clock-like mechanisms for telling time or driving mechanical musical devices as well as doll or robotic-like devices for entertainment. The player piano was a popular mechanical form of automata. In the Renaissance, engineers such as Leonardo da Vinci often designed fountains with time changing flows or moving props for stage productions and pageants as part of their duties for their patron. In the late 18th century, Jacquard designed punched cards to control textile machines. James Watt also invented a rotating ball speed controller for his steam engines. In the early 19th century Charles Babbage tried to build a machine with 15,000 parts to automatically generate mathematical tables for astronomy and navigation. By the 20th century, the idea of the *controlled-machine* and robotics reached maturity with the development of electronics.

SMART MACHINES, MECHATRONICS

Smart machines contain arrays of sensors and small computers called micro-processors to monitor the state of the machine and to adjust the actuation forces. *Mechatronics* is a term coined by Japanese engineers and reflects the interaction between mechanical, electrical and information or computer sciences to create a smart machine. *Smart machines* introduce new basic elements into machine design such as ‘*piezoelectric patches*’ for sensing and actuation, *microprocessors* and embedded computers for handling information and decision-making or video-cam optical devices and MEMS sensors. The individual ‘machine designer’ has been replaced by an interdisciplinary *team* with specialists and generalists who piece together the hundreds of mechanical elements and electronic components in each new generation of machine. In this process, the ‘team’ pushes the boundaries of the previous model using both conventional machine elements and whatever new electronic, optical and software technologies have made it into the marketplace.

DECONSTRUCTING LEONARDO’S MACHINES

There are many books on the machines and inventions of Leonardo da Vinci. In this book however, we are focused on the basic language of machine invention – the fundamental machine elements and basic kinematic mechanisms. In the previous sections we have illustrated the deconstruction of a modern consumer machine and also the first automobile of Karl Benz and here we deconstruct one of Leonardo’s machines for textile manufacturing. A question of interest to us is; to what extent was Leonardo aware of using a basic language of machine invention?

Of the hundred or more complete machines that he drew in his manuscripts, the Automated Spool-winding Machine is extremely interesting because it was not only drawn in a fairly complete way, but it also contained many machine elements and five kinematic mechanisms. Often Leonardo’s machines are portrayed in the context of war and adventure; multiple cross-bows, catapults, flying machines and an automated three-wheeled vehicle (see Table I.2). However, both Florence and Milan were important textile producing cities and Leonardo seems to have had some motivation to design several machines for wool and silk textile machines, so much so that there are two modern monographs describing his machines for the textile trade, Giovanni Strobino’s 1939 book in Italian, *Leonardo inventore tessile*, and Kenneth G. Ponting’s 1979 book, *Leonardo da Vinci, Drawings of Textile Machines*.

Table I.2. Classification of Leonardo's machines by application

Manufacturing Machines	Source	Construction Machines	Source
Lathe	F1059r/381r.b	Cranes	F4r/1v.b
Screw cutting machine	Ms. G 70v	Swing bridge	F855r/312r.a
Rope making machine	F12r/2v.a	Canal dredge	Ms. E 75v
File making machine	F24r/6r.b	Canal lock gates	F90v/33v.a
Drilling machine	F34r/9v.b	Pumps	F20r/5r.b
Lens-grinding machine	F1057v/380r.b	Hydraulic screw pump	F1069v/386v.b
Needle-making machine	F86r/31v.a	Chain-of pots pump	F1069v/386v.b
Thread spinning machine	F1090v/393v.a	Pulley systems	F1102v/396v.g
Textile machines	F106r/38r.a	Windlass	F1112r/400r.a
Book press	F995r/358r.b		
Wine and olive press	F47r/14r.a	Power and Transmission	
Mechanical saw	F1059r/381r.b	Boat paddle wheels	F945r/344r.b
		Air turbine wheel	F46a-r/13v.b
Military Machines		Water power systems	F26v/7v.a
Bombs	F33r/9v.a	Spring-propelled cart	F812r/296v.a
Balistica	F145r/51v.b	Power transmissions	F26v/7v.a
Trebuchet	F160a-r/57v.a	Flying machines	F844r/308r.a
Catapults	F150r/54r.a	Human powered wheel	F1070r/387r.a
Armed chariots	Turin BB 1030		
Breech-loading mechanism	Ms. B 24v	Measurement Devices	
Giant Cross-bow	F149b-r/53v.b	Clock escapements	F96r/35r.a
Rapid-repeating crossbows	F182b-r/64v.b	Odometer cart	F1b-r/1r.bk
Steam-gun	Ms. B 33r	Weighing machines	Ms. A 52r
Multi-barrel gun	F157r/56v.a	Drawing compass	F696r/259r,a-b

Sources: *Codex Atlanticus*; Folio: F; New/Old numbers

Paris Manuscripts; Ms. A-M

The automated spool-winding machine can be found in the *Codex Atlanticus*, Folio 1090v, shown in an isometric drawing with shading and a cross-sectional view of the axel system (see Figure I.15). The main steps in textile production involve spinning thread, weaving, calendaring or pressing the cloth, beating the wool and dyeing the cloth. In the drawing of Figure I.15 the input motion is represented by a crank on the rear right side and the output is the thread wound on the spool on the right front side.

The action of the flyer is to twist the thread in a helical pattern on the spindle. To achieve this pattern the flyer and spindle are caused to rotate at different speeds and the flyer is made to move back and forth. Leonardo cre-

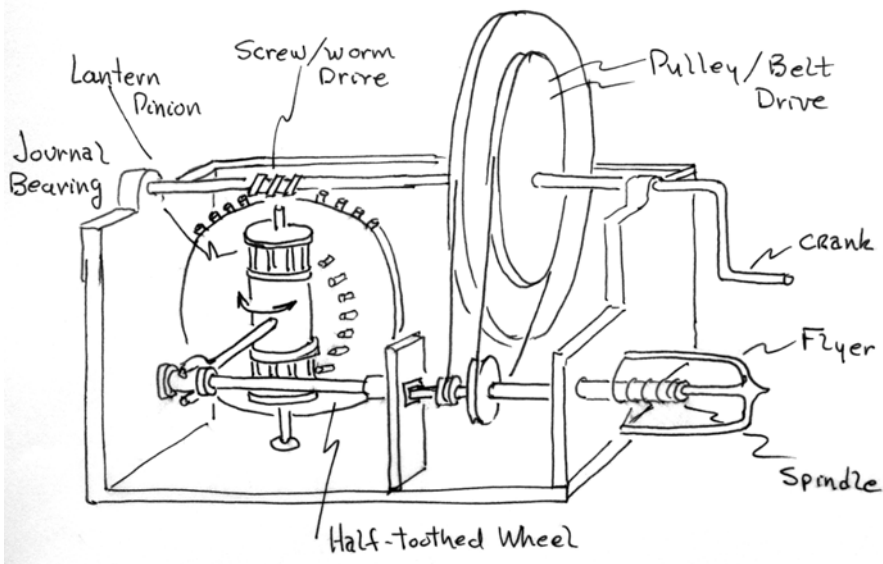

Figure I.15. Sketch of kinematic elements in Leonardo's textile spinning machine (based on *Codex Atlanticus*, Folio 1090v)

ated a speed differential in rotary motion of the flyer and spindle by using two different wheel-belt pulley drives, both fed off the same crank motion. To create a relative oscillatory motion of the flyer and spindle, the shaft is feed through a double-slider linkage coupled to an oscillatory cylinder rotated on the left side about the vertical axle. The oscillating motion is produced with an *intermittent mechanism*. Leonardo created a mangle by using two lantern pinions on the same vertical shaft and using a partially toothed crown-wheel gear rotating about the horizontal axis. The teeth on the vertical wheel first engage the double pinion at the bottom turning it in one direction, and then engage the upper lantern pinion turning it in the opposite direction. The sliding link attached to the double pinion moves the horizontal shaft back and forth. Finally the partially toothed crown wheel gear has another set of pin type teeth on its outer rim that are driven by a helical screw, called an endless screw or worm drive mechanism.

The machine elements in this machine as categorized by Franz Reuleaux include:

- (i) journal and thrust bearings;
- (ii) belts and pulleys;
- (iii) toothed wheels (gears);
- (iv) revolute and prismatic (sliding) joints;

(v) screw elements.

The kinematic mechanisms in this machine include:

- (i) two belt drives;
- (ii) a double slider linkage;
- (iii) a mangle or intermittent mechanism;
- (iv) an endless screw mechanism.

We do not know if Leonardo invented this design or whether he copied it from existing machines of the time. However, it is an interesting proposition that if one is given the need for such a machine and given a list of five machine elements and four mechanisms, could one create such a machine? How did Leonardo create such a machine if he did not copy it? Perhaps he saw a similar machine and was inspired to make improvements. He was trained as a painter and sculptor not an engineer. Or was it because as some have claimed, he was a genius.

Reuleaux believed that genius was not essential to creating a new machine; there was a rational process behind invention, though he had never quite discovered it. Reuleaux posited that a necessary condition for machine synthesis was knowledge of its basic language; machine elements and kinematic mechanisms. Leonardo da Vinci believed that there were rational principles to the art of painting based on mathematical proportions and perspective. There is now evidence that Leonardo had similar beliefs about invention of machines.

I.4 LEONARDO, 'INGÉNIEUR ORDINAIRE'

Was Leonardo an artist who dabbled in sketching machines or was he an engineer who painted in his off-hours? To place our discussion of Renaissance machine design and invention in context, we review the salient facts about the life and times of Leonardo da Vinci. There are literally hundreds of books on Leonardo as an artist, though there are less than a dozen paintings attributed to him. In this brief summary we review those aspects of his life related to his work as a royal engineer. There is often debate as to the facts and dates surrounding the life of Leonardo. Many of the dates given here are from the works of Kenneth Clark (1939, 1988), Ivor B. Hart (1961) and Charles Gibbs-Smith (1978).

Leonardo was born on April 15, 1452 in the village of Vinci northwest of Florence. His death is recorded as May 22, 1519 in Amboise, France. His was an out-of-wedlock birth whose father Ser Piero da Vinci was a notary and who acknowledged Leonardo's patronage and took him into his home. As a teenager, Leonardo was apprenticed into the workshop of the painter, sculptor and goldsmith, Andrea del Verrocchio [1435–1488] around 1470 where Sandro Botticelli was also a student. There he learned the skills of drawing, painting, sculpture and perhaps architecture. Leonardo later joined the Guild of St. Luke as a painter at the age of 20 while still living in Verrocchio's studio. Several biographers write that he likely had some formal education and studies in mathematics. However he did not receive study in Latin and tried to learn this language of science and literature later in life. Leonardo's Notebooks were written in Italian and he had considerable knowledge of geometry. His right to left writing was likely a consequence of his left-handedness and not an attempt to hide his knowledge as some have speculated.

From the age of 20 to 30 in Florence, Leonardo developed a reputation as a genius artist with creations such as the 'Ginevre de' Benci' (1474) now in the National Gallery in Washington DC, 'The Madonna and Child' (1476) in the Alte Pinakothek, Munich, and the 'The Benois Madonna' (1478–1480) now in the Hermitage, St. Petersburg. The definitive text on the paintings of Leonardo da Vinci is that of Kenneth Clark (1939). However this classic work does not discuss nor describe Leonardo's drawings of machines in Leonardo's Notebooks, not even from an artistic point of view.

The 15th century was a time of tremendous change and political tension, especially in the Italian states. Two of the most powerful rulers during Leonardo's years in Florence were Cosimo de' Medici [1389–1464] and Lorenzo de' Medici [1449–1492]. Under both rulers art, architecture and literature flourished. Under the reign of Cosimo, the architect-engineer, Filippo

Brunelleschi, completed the great octagonal dome (55 meters across) of the Cathedral of Florence in 1436. The movable-type printing press was invented by Gutenberg in 1450, and by 1500 there were nearly 300 printing press workshops in the Italian states. (This is important because Leonardo would have had an opportunity to disseminate his ideas and writings had he so chosen.) Florence was a center of silk and wool textile manufacturing, Italian mariners had taken a new class of sailing ships as far west as the Azores and later in 1492, Columbus would make the most fantastic voyage to the New World. Copernicus was born when Leonardo was 21. Politically however, times were very unstable. Constantinople fell to the Turks in 1453, and there was constant strife between the multifarious Italian states as well as interlopers such as the French and the German states that looked on this lack of unity as an opportunity to acquire new territory and hegemony. One can clearly understand the demand for military engineers by powerful regional rulers as well as for artists and sculptors.

At the age of 30 in 1481, Leonardo wrote a remarkable resume for the Duke of Milan, Ludovico Sforza [1452–1508], known also as ‘il Moro’. A draft of this letter in his notebooks (CA Folio 1082r/Folio 391r.a), boasts of Leonardo’s skills as a military and civil engineer and briefly mentions his considerable skills as a painter and sculptor at the end of this letter.

Having, most illustrious sir, seen and considered the experiments of all those who profess to be masters in the art of invention of the apparatus of war and, having found that their instruments do not materially differ from those in general use, I venture, without wishing to injure anyone, to make known to your Excellency certain secrets of my own, briefly enumerated as follows;

Among the list of ten skills that Leonardo boasts to Il Moro are the following;

4. I know how to make light cannon of easy transport, capable of ejecting inflammable matter, the smoke from which would cause terror, destruction and confusion among the enemy.

7. I can make cannon, mortars and engines of fire, etc., of form both useful and beautiful and different from those at present in use.

10. In times of peace I believe that I can compete with anyone in architecture and in construction of both public and private monuments and in the building of canals.

—; in painting I can do as well as anyone else.

This job description is not unlike that of a modern engineer, who is often employed in defense industries in times of real or threatened war. The other

interesting point is Leonardo's description of these engines of war as 'beautiful'. Engineers then and now often look at a new creation with a sense of beauty and awe, independent of the moral use of the new technology and Leonardo seems to be no different.

In 1482, Leonardo left for Milan and was appointed 'ducal painter and engineer'. He spent the next 18 years working for Il Moro, serving as consultant on fortifications at Milan, Pavia, and Vigevano. He completed his famous painting 'The Last Supper' in 1497. In 1498, he was given a vineyard property by his patron with the title *ingegnere camerale*. Leonardo stayed in the service of the Duke for 17 years. In 1499–1500, Ludovico Sforza was displaced by the French King Louis XII in his occupation of Milan, and Leonardo left for a brief stay in Venice in 1499 and later returned to Florence in 1500. In Venice he was occupied with some military consulting for the Venetian Senate. He also worked with the mathematician Pacioli who had fled with Leonardo from the troubles in Florence.

Besides undertaking some paintings, a great deal of Leonardo's service to 'Il Moro' was involved in surveying fortifications, devising town plans, drawing plans for canals, organizing pageants and providing advice on military technology. To carry out these tasks there are a number of names in his Notebooks of workers and students in his Milan workshop whose professions were machine makers, locksmiths and glass craftsmen suggesting that he was surrounded by men who had some experience and knowledge of machines and technical processes.

During his time in Milan, Leonardo traveled to Pavia in 1490 and met the older Francesco di Giorgio Martini [1439–1501] from Siena a respected artist-engineer who, following the work of another Siennese engineer Mariano Taccola, had published a widely circulated book with descriptions and drawings of machines for military and construction purposes. From a record of books in Leonardo's library, we know he had a copy of Francesco's book on architecture and machines. In fact most of Leonardo's own Notebook drawings of machines date from after this time (Table I.2).

Another important contact *vis-à-vis* his education as a machine designer and engineer, was his friendship with the mathematicians such as Fazio Cardano of the University of Pavia and Fra Luca Pacioli who later wrote on arithmetic and geometry. Leonardo drew the illustrations for Pacioli's book *De Divina Proportione* in 1509. The relation between mathematics and machines has its origins in the work of Aristotle, Hero, and Archimedes. The earlier picture books of Taccola, and Francesco di Giorgio however, did not show the precision that was necessary for machine construction until the work

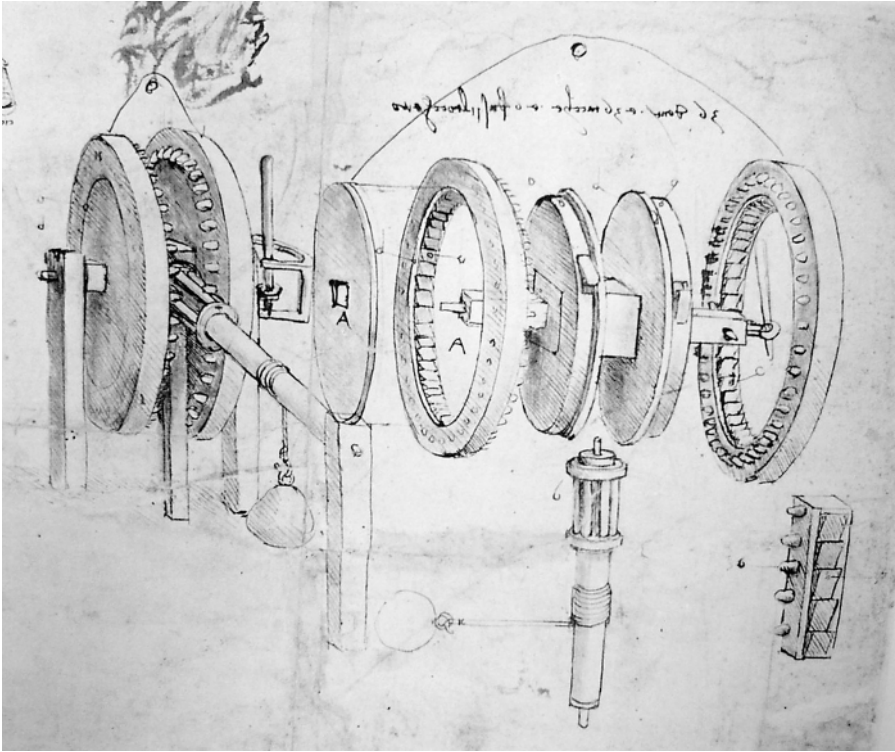

Figure I.16. Leonardo da Vinci: Exploded view of a ratchet winch (*Codex Atlanticus*, Folio 30v/8v.b)

of Leonardo whose interest in geometry is clearly visible in his machine drawings. Often one finds both geometric drawings and machine components drawn on the same page. His exploded views for some machines give one the confidence that one could reproduce these machines from his illustrations (Figure I.16). This emergence of careful attention to geometric and perspective details later appeared in the machine books of Besson (1578) and Ramelli (1588).

Leonardo's Notebooks contain many studies on the science of mechanics and dynamics. In later centuries, Galileo and Newton would focus such study on the motion of heavenly bodies. However the science of mechanics is also intimately connected to the design of machines. Leonardo spent considerable time on the subjects of equilibrium of forces, strength of materials, friction, elastic bodies and the bending of beams, cracks in solids, the motion of projectiles and a considerable effort on the motion of fluids or hydrodynamics. The subject of mechanics is highly relevant to the design of machines such as

in the problem of bearings to reduce friction, and in the design of pumps to move water or the construction of large flexible crossbows. Leonardo's troika of interest in geometry, mechanics and machines was the beginning of the scientific codification of engineering design, a process that continued to the end of the 19th century and the work of the engineer-scientist Franz Reuleaux. Of the study of mechanics Leonardo would write in his Notebooks (Ms E 8v) this oft quoted aphorism: '*Mechanics is the paradise of the mathematical sciences because by means of it one comes to the fruits of mathematics*'.

In 1500, Louis XII of France occupied Milan and Leonardo left for Venice and Florence and then a tour of duty in Rome with Cesare Borgia, Duke of Romagna. During this time Leonardo produced maps for the construction of canals, another engineering task that involved careful geometric drawing skills. In the 20 years after he had left Florence he had started a number of paintings and sculpture projects, but very few were ever finished or survived. Shortly after the Milan period, Leonardo completed his famous Mona Lisa, completed in 1503, now in the Louvre in Paris. In 1506, Leonardo returned to Milan for a few months. The French who were still in Milan referred to Leonardo as '*notre peintre et ingénieur ordinaire*'. He also spent a short time in Rome from 1514–1516, but was overshadowed artistically by the younger Michelangelo and Raphael.

In the post Milan period 1507–1509 Leonardo took a stronger interest in scientific studies especially those involving anatomy, hydrodynamics of water and the flight of birds including the design of flying machines. One of his notebooks of 30 pages is entitled *Codice Sul Volo degli Uccelli* (1505) or 'On the Flight of Birds'. Some of these wing-like devices exhibit cable and linkage designs similar to those that appeared centuries later in the work of Otto Lilienthal, who was a student of Franz Reuleaux at the Berlin Polytechnique.

Finally like a man without a country, in 1516–1517 Leonardo received an offer to reside in the palace of the French King Francis I at Chambois, where he received an appointment as '*Premier peintre et ingénieur et architecte du roi*'. Here Leonardo lived in an 'emertius' status, a royal trophy artist, often conversing with the King but with few duties. Leonardo died in 1519 at the age of 67 and was buried at the Church of St Florentin, Amboise.

Although Leonardo made thousands of drawings, sketches, designs and pages of notes on dozens of subjects, we have no record of a published book. There is some historical reference to a book on principles of painting. But in engineering, he did not write or publish any book on the subject for which he later gained universal respect, the design and invention of machines. His drawings, papers and notebooks were bequeathed to a younger

pupil, Francesco Melzi [-d. 1570] who kept them until his death at which time Melzi's son mishandled them. These papers were later given to the sculptor Pompeo Leoni who tried to reorganize the welter of drawings into codices related to several themes. In this work he often cut out drawings and pasted them into other works. The largest collection of manuscript pages was called the *Codex Atlanticus*, over 1000 folios, and was given to the Biblioteca Ambrosiana, Milan. This large twelve-volume work contains hundreds of machine drawings. This work was first published in facsimile in 1894 and can be found in many large libraries around the world. A compressed three-volume version has recently been published in Italian in 2000.

Another codex is in Windsor, England as well as a few smaller books at the Victorian and Albert, in London. There was a set of 13 smaller notebooks labeled A–K that were looted in Milan by Napoleon's troops in 1796 and now reside at the Institut de France in Paris. Several of these books, namely *Manuscripts B, G, and H* contain machine drawings. The other major books were in the National Library Madrid, Spain but were 'lost' in the 19th century due to misfiling. In 1965, the *Codex Madrid I and II* was found and were translated and reproduced in facsimile. These works contain over a 1000 important drawings of so-called *machine elements*, the basic building blocks of all machines.

The late da Vinci scholar, Ladislao Reti, in the process of translating the newly discovered *Codex Madrid*, made a very important observation that is summarized in Table I.3; that Leonardo's drawings of elements of machines correlated with a list of such machine elements compiled by Franz Reuleaux in the late 19th century.

In 1938, Edward MacCurdy published a translation of many of the text sections in the Leonardo's Notebooks. These quotations reveal the extent of his self-education and readings. In different codices Leonardo mentioned the Roman engineer Vitruvius, Archimedes, the Commentaries of Caesar, or the geometry of Euclid. In a remarkable discovery in the recently translated *Codex Madrid II*, was a list of "*books I have left locked in a chest*". This list of over 100 books includes works on Aristotle, The Bible in Italian, Letters of Ovid, St Augustine, Justinus-Roman historian, Fables of Aesop, Petrarch and Pliny. In mathematics, he had books by Euclid and Luca Pacioli. In architecture and engineering his library contained books by Alberti, Valturio and Francesco di Giorgio as well as one entitled 'A Book of Engines'. There is also one likely to be Philon of Byzantium's 'Pneumatics'. It is interesting to note that although the Roman engineer Vitruvius is mentioned by Leonardo in several locations in his manuscripts, his work is not listed in the book list

Table I.3. Reti’s comparison of Leonardo’s and Reuleaux’s basic machine elements

Reuleaux’s ‘Constructive Elements’ in <i>Kinematics of Machinery</i> , 1876	Leonardo’s ‘Elementi macchinali’ <i>Codex Madrid I</i>	
Screws	Section 107	Folio 26r
Keys	Section 108	Folio 46v
Rivets	Section 109	—
Bearings	Section 112	Folio 101r
Pins, Axles and Shafts	Section 110	Folio 10v
Couplings	Section 111	Folio 62r
Ropes, Belts and Chains	Section 113	Folios 9r, 23r, 10r
Friction Wheels	Section 114	Folio 102r
Toothed Wheels	Section 115	Folio 15v
Flywheels	Section 116	Folio 35r
Lever, Connecting Rods	Section 117	Folio 1r
Click Wheels	Section 119	Folio 117r
Ratchets	Section 121	Folio 12r
Brakes	Section 122	Folio 10r
Engaging & Disengaging Gear	Section 123	Folio 2r
Pipes	Section 125	Folio 25v
Pump Cylinders, Pistons	Section 125	Folio 5r-b (<i>Cod. Atlanticus</i>)
Valves	Section 126	Folio 115r
Springs	Section 127	Folio 85r
Cranks and Rods	Section 117	Folio 28v
Cams	Section 145	Folio 6v
Pulleys	Section 158	Folio 155r

in *Codex Madrid II*. Vitruvius’s Book X of his treatise on Architecture was a key reference to machine engineering of Roman and Greek antiquity.

Compared to today’s students of engineering and science, Leonardo had a wide knowledge of the liberal arts. He certainly did not fit the modern stereotype of the narrow technologist or what is today called a ‘nerd’. Leonardo was widely read and cosmopolitan in his interests as well as widely traveled, which also characterized the 19th century engineer-scientist Franz Reuleaux whose life we describe at the other end of the four centuries of the evolution of the machine.

INFLUENCE NETWORK OF LEONARDO DA VINCI IN MACHINE DESIGN

Leonardo da Vinci is sometimes portrayed in contemporary media as a singular genius especially in the subject of machines and inventions. However as there were artistic influences of earlier painters and sculptors on Leonardo's art, there were also earlier architect-engineers and artist-engineers who were either building or drawing designs for machines and whose work likely had some influence on Leonardo.

One of the popular methods to graphically summarize the evolutionary influences of ideas in machine design and invention on Leonardo da Vinci is with an influence network chart shown in Figure I.17. A similar chart was made by Ladislao Reti for the work of Francesco di Giorgio (see Figure II.33 in Part II of this book), as well as the chart for Franz Reuleaux in the following section. In this chart, time flows from left to right. On the left representing antiquity, we have the work of Archimedes, Ctesibius and Hero of the Greek Alexandrian School summarized by the Roman architect-engineer Vitruvius around 27 CE. These works are cited as influencing Leonardo because the work of Vitruvius was rediscovered in the 15th century and Francesco di Giorgio attempted a translation himself. There is also the influence of thinkers such as Roger Bacon and scholars in mathematics and mechanics in the late Middle Ages such as Villard Honnecourt or perhaps the Arab writer al-Jazari, but the direct links to the Renaissance engineers is not clear. Another engineer of record is Guido de Vigevano (1335).

What is clear is the influence of Filippo Brunelleschi and his chroniclers such as Ghiberti and Sangallo, who made drawings of many of his construction machines (see e.g. E. Battisti, 1981, 2002, pp. 132–136; P. Galluzzi, 1997, pp. 93–116). Another established line of influence is that of Mariano Taccola and Francesco di Giorgio Martini. Since Leonardo had a copy of di Giorgio's work in his library, a direct connection between Leonardo and Francesco di Giorgio seems appropriate. I have shown a solid arrow to indicate that Leonardo had copies of the works of other nodes of the chart, such as Leon Batista Alberti, Roberto Valturio, and Bonaccorso Ghiberti. Dashed lines indicate probable influence on Leonardo's machine work, such as that of Giuliano da Sangallo. Earlier machine catalogs of the late 14th century such as those by Giacomo Fontana and Konrad Kyeser (c. 1405) are likely to have influenced 15th century engineers but the direct evidence is not clear.

The influence lines of Leonardo himself on other contemporary and later nodes are more problematic since his manuscripts were never published. However some scholars, such as Ivor Hart (1961) believe that the executor of the manuscripts after Leonardo's death in 1519, Francesco Melzi, may

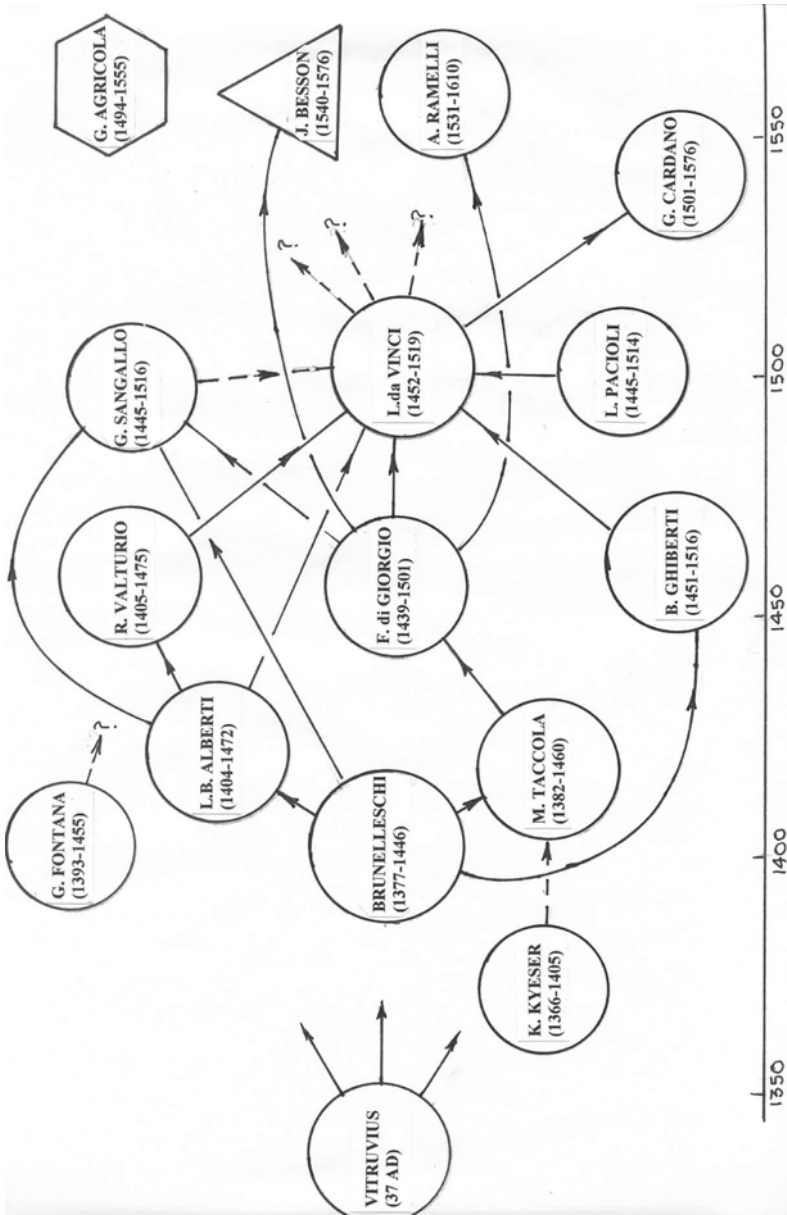

Figure I.17. Influence network of Leonardo da Vinci

have allowed certain artists to make copies from the manuscripts or allowed scientists and scholars to read some of the manuscripts in the half century period that Melzi had them in his possession. Two possible lines of influence of Leonardo are Fazio Cardano [1444–1524] and his son Girolamo (Jerome) Cardano [1501–1576]. The latter became a famous mathematician and is credited by Reuleaux as having described the famous kinematic mechanism for transmitting rotary motion from non-aligned shafts called the *Universal Joint*.

Within the half century period of Melzi's caretaking were published important machine books of the Italian Agostini Ramelli (1588) and Besson (1578) in France. The machine book on mining by the German, Georgius Agricola (1556) was also published in this period as was one on metallurgy by Biringuccio (1540). (See Section II.9, for a discussion of the so-called 'theatre of machines books' of the 14th through 18th centuries.) According to Gille (1966) other technology books on agriculture, chemistry and arms appeared in 16th century after Leonardo's death by authors from what is now England, Spain, Germany and Italy. This plethora of knowledge books on engineering and technology was one of the hallmarks of the Renaissance machine age.

One can debate the details about direct or indirect influence on and by Leonardo's work in machines and mechanics. However the overall features of the influence chart in Figure I.17 support the premise of this book and earlier works, that workshop knowledge of machine creation evolved over several centuries, especially during the Renaissance.

I.5 FRANZ REULEAUX: ENGINEER-SCIENTIST

The Age of Machines in the 19th century had many well-known personalities such as Siemens and Otto in Germany, Watt and Brunel in England, and Fulton and Edison in the United States. When a lesser-known figure such as Franz Reuleaux is studied, it is natural to compare him with the more famous men of the industrial revolution. However in his day, Franz Reuleaux [1829–1905], was very well known for his theories in machine design and was a player on the stage of new technologies. He was a principal consultant to Otto and Langen on the gas combustion engine as well as a friend of Siemens. He was ambassador to international expositions, a proponent of German educational theories and an advocate for machine style and art in the industrial age. He was such a cosmopolitan personality that he garnered recognition and honors around the world, was referenced in dozens of books and papers and memorialized in Berlin with a monument and a named street, yet was forgotten by the end of the 20th century. Reuleaux was not an inventor like James Watt, or an entrepreneur like Werner Siemens, nor was he a scientist like Faraday or Henry. Yet he played a crucial part in the later stages of the 19th century machine age, the role of engineer-scientist, professor, university head, advisor to industry and government.

One way to begin to understand a historical figure like Reuleaux is to paint a portrait of him through his words and images. Picture a bearded man with a large head, high forehead, deep set eyes, receding hairline, dark wavy hair swept back over large ears to just below his collar. His pictures show a hand tied cravat and a vest or waistcoat under a frockcoat. His letter books contain copies of thousands of letters in German, French and English written in a flowing pen with a bold finish of his name *Reuleaux*. These letters are addressed to colleagues, students, and industrialists in a formal, gracious, courtly style that one often associates with the Victorian age. There is one picture of Reuleaux standing next to his desk in a silk lapelled morning coat that suggests he was no more than one meter and two-thirds in height, or about five feet five inches. Yet his photographs convey an imposing personality.

If Leonardo's fame as an artist overshadowed his life as an engineer and scientist, in the case of Franz Reuleaux, his practical books on machine design have overshadowed his interest in a theory of invention and creativity in mechanical artifacts.

In each new age of intellectual creation, the inventor works as does the artist. His genius steps lightly over the airy masonry of reasoning—It is useless to demand of the artist or inventor an account of his steps. (Reuleaux, 1876a, p. 6)

At the same time Reuleaux recognized the new role of science and mathematics in developing a rational method of machine design. In speaking about the industrial progress of the 19th century he remarked that

The forces of nature which that advance taught us to look for – are mechanical, physical and chemical; but the prerequisite to their utilization was a full [employment] of mathematical and natural sciences. (Reuleaux, 1885, p. 7)

Short biographies and obituaries written about Franz Reuleaux are laudatory and respectful, in awe of his accomplishments. Though he had many admirers, he also had strong critics. One does not play a leading role in the development of engineering at the Zurich Polytechnique, sit on the German patent board, head the Berlin Industrial Academy for 12 years and play an important role at the Royal Technical University in Berlin without making political enemies.

Reuleaux's family had Belgian roots in the 18th century as pump makers and hydraulic engineers in a village near Liege. Later in the early 19th century the family moved to a village outside of Aachen called Eschweiler-Pumpe. After the fall of Napoleon in 1814, Aachen or Aix la Chapelle was ceded to Prussia and later became absorbed into Bismarck's united Germany after the German-Franco war in 1867. Franz's father was one of the first manufacturers of steam engine pumps in Belgium and Germany. Franz was born in 1829. His father died in 1833 before he was five and the family moved to Koblenz where one of his uncles continued the family business. Living in the Rhine Valley, it was perhaps natural that the young Reuleaux would attend the Karlsruhe Polytechnique Institute [1850–1852] to study machine engineering with the then famous Ferdinand Redtenbacher. After two years Reuleaux went to Berlin to study philosophy and the natural sciences and then to Bonn to continue studies. Returning to the Rhine Valley, he worked in the family business building machines. He also worked at a mechanical institute in Cologne. In 1856 at age 27 he was invited to become professor of mechanical engineering at the Zurich Polytechnique Institute, now known as the Swiss Federal Technical University, or ETH (Eidgenössische Technische Hochschule).

In 1864 he began his leadership positions in Berlin, where he would spend the rest of his career first as director of the Gewerbeakademie (1868–1879) and then as rector (1890–1891) of the combined Gewerbeakademie and the Bauakademie, that formed the Technische Hochschule Berlin. At TH Berlin, Reuleaux was the director of mechanical engineering. He also held the title,

Royal Privy Councilor, and served as a consultant to the new German Reich. Reuleaux was a member of the Imperial Patent Office for eight years.

Reuleaux's father Johannes Joseph was born in Eschweiler-Pumpe in 1796. Records indicate he was baptized a Catholic. He is listed in records as a 'Mechanikus und Fabrikant' Reuleaux's mother, Walburga Carolina Heloisa Graeser [1803–1867] also from Eschweiler was baptized Evangelical or Lutheran as called in the US. His mother was a writer of children's books and novels for young girls under a pen name 'Die Grossmutter'. Reuleaux's parents had five boys and two girls. One of Franz's sisters died in 1832, age 13 months, and a younger brother died shortly after the death of his father at age 8 months. Of his three older brothers, two became engineers. One brother, Ludwig (Louis in some records) is recorded as a manufacturer or 'Fabrikant'. Later in life he became head of the Mainz Trade Council. Because his father died when Franz was age six, it is likely that Franz was influenced more by his uncle and older brothers, than by his father. Also, his mother, who later moved with Franz and his wife to Berlin, may have encouraged his interest in art and literature (see Zopke, 1896 and Seiflow, 1999).

Reuleaux married Charlotte Overbeck [1829–1908] of Antwerp, Belgium. They had three girls and two boys – Caecilie [1857], Mathilde [1859], Else [1869] who died at age four. One son Oscar [1861–1920], had the title Major in references, while the younger son Eugen, born in 1866, went to the US in 1894. There are genealogical records that trace his family to Canada and Wyoming. There is a copy of a letter of Reuleaux to a manufacturer in the US seeking a job for his son. Although Reuleaux traveled all over the world in his professional life, there are no references in his letters we have seen that his wife ever traveled with him.

Franz Reuleaux was a collector. He not only built a collection of 800 models of machine mechanisms in Berlin, at home he collected spindles used by primitive and non-industrial societies to spin thread. A rare photo of him in his office at home shows him attending to this collection. The darkly paneled Victorian decorated room also shows a collection of vases on shelves below the ceiling. Letters of Reuleaux to the Smithsonian Institute in Washington DC contain references to stuffed animal heads that he wanted sent to him in Berlin. He was also interested in anthropological artifacts during his trips to Australia and India. Reuleaux was president of the Berlin Art Dealers Association for several years and was appointed by the Kaiser to purchase art for a museum in Berlin.

His penchant for collecting reached its pinnacle with his vast kinematic model collection in Berlin. Even here, many models were of mechanisms

that had origins in antiquity such as the endless screw or the verge and foliot clock escapement of the late Middle Ages. Reuleaux believed that understanding machines of the past had lessons for contemporary design; ‘*the thorough understanding of old mechanisms is even more important than the creation of new ones*’ (Reuleaux, 1876a, p. 21).

After leaving Karlsruhe, Reuleaux published a handbook on machine design in 1854 with a fellow student Carl L. Moll. Their former Professor Redtenbacher from Karlsruhe however was not happy and accused his former students of publishing his class notes. Later Reuleaux published the first edition of his popular machine design text *Der Constructeur* in 1861. This work went to four editions and four languages, including an English edition in 1893. This work contains descriptions of many different types of machines as well as machine components (Table I.4). The first editions of this work had very little kinematics of machines. Reuleaux’s German text *Theoretische Kinematik* appeared in 1875 and was quickly translated into English in 1876 as *The Kinematics of Machinery: Outlines of a Theory of Machines*. A second volume appeared in German in 1900.

Besides his prolific technical writing, Reuleaux wrote a controversial book on his visit to the 1876 Centennial Exposition in Philadelphia, called *Briefe aus Philadelphia*. He also wrote a book on his travels to India in 1881, (*Eine Reise Quer durch Indien*) complete with numerous lithographs of the people and sights there. During his visit to the Chicago Columbian Exposition in 1893, Reuleaux was inspired to translate Hawthorne’s poem ‘Hiawatha’ into German. As a result of his second visit to America, he wrote a report on American machine industry (*Mittheilungen amerikanische Maschinen-Industrie*). A truly remarkable achievement is his editorship of a nine volume series of books on inventions, called *Buch der Erfindungen*, in the 1890s. What is special about this encyclopedic work are the nearly 1000 lithographs that show not only machines and industrial processes but also hundreds of pictures showing workers and machines including many of women involved with technology and in the factories.

Reuleaux also had concerns about the impact of technology on society and the disparity between the nations with technology and those who are without. In a speech in the 1880s titled, ‘Cultur und Technik’ later translated into English in 1885 and published by the Smithsonian Institution, he posed this enigma:

- a full two thousand years ago,– Indian poets had produced their nation’s Odyssey, the Mahabharata, and dramas in rich abundance.
- Philosophy flourished – Mathematics too was fostered. – Where

Table I.4. Selection of machines cited in Franz Reuleaux's *The Constructor*; 4th Edn(1893)

Manufacturing Machines	Page	Construction Machines	Page
Cotton-spinning machinery	124	Cranes	27, 38, 89
Seller's engine lathes	126	Bridge roller bearings	126
Seller's planing machine	140	Hoisting machinery	156
Wine press	154, 241	Chinese windlass	174
Saw mill feed mechanism	160	Pumps: Pappenheim, Payton, etc.	219, 220
Jacquard loom-ratchet gearing	163	Archimedes screw pump	221
Eckert threshing mill	186	Franklin's double pump	224
Jacob's grinding mill	187	Canal locks	227
Hydraulic riveting machine	228	Hydraulic ram	233
Sand blast machines	241	Worthington duplex pump	231, 232
Electro-plating machines	241		
Nasmyth steam hammer valve	286	Power and Transmission	
		Steam engines	110
Military Machines		Steam engine flywheels	143
Gun locks; releasing ratchets	162	Corliss steam engine valve gears	162
Mauser revolver; locking ratchet	166	Dynamo-electric machines	171
		Hot-air engines	171
Transportation Machines		Hydraulic piston and cylinder	216
Wagon wheel suspension springs	20	Compressed air distribution	219
Locomotive Wheels	125	Water turbine wheels-Borda	220
Stephenson's locomotive valve gear	143	Screw turbine, Cadiat's turbine	220
Railroad brakes	164	Windmills	220
Westinghouse railroad air brakes	171	Hornblower compound engine	234
San Francisco cable tramway	174	Vacuum pump valve gear	236
Atmospheric railway of Pinkus, 1834	227	Riedler pumping engine	278
Hydraulic ship steering gear	237	Gas main gate valving	282
Davies steering gear	238		
Locomotive boilers	271	Measurement & Communication	
		Thomas Calculating machine	153, 156
		Morse telegraph	163
		Thomson telegraph	164
		Clock escapements, Le Roy, Arnold	167, 168
		Recording telegraph	171

then, is the difference in intellectual sphere which has allowed a separation between them and us? – Let us ask, whence is the source of our material preponderance over them? How, for example, has it become possible that England, with a few thousands of her troops, should rule supreme over a quarter of a milliard [*sic*] of the natives of India. (Reuleaux, 1885, p. 3)

Reuleaux went on to argue for an education system based on science. This and other writings, shows his interest in societal questions beyond his technical studies.

What is also amazing about Reuleaux is that these books and writings were accomplished throughout a period from Zurich in 1856 to Berlin 1896 when he was either head of a department, institute or president of a university, along with his royal appointments in the patent office and as industrial consultant.

How can we compare Franz Reuleaux with Leonardo da Vinci? Both grew up in a workshop tradition but attempted to generate principles of machine invention and design later in life. Both were engineering advisors to government and royalty. They each communicated with many creative and influential people of their day. Though Reuleaux was never a professional artist like Leonardo, he loved to draw and illustrate his books with hundreds of drawings. In spite of their love of machines, neither became a producer of machines though Reuleaux did reproduce his small kinematic models for universities. Their differences are also important. Leonardo never received a formal education. Reuleaux married and had a family. Both Leonardo and Reuleaux were famous in their day; yet at the end of their lives, each had suffered a loss of influence. Perhaps their most unifying trait was their love of machines and the belief that the invention of mechanical devices was a wonderful gift to those who could master this art.

‘FATHER’ OF KINEMATICS OF MACHINES

Unlike James Watt, who was an instrument maker and craftsman, Reuleaux and his fellow engineer-scientists were trained in science and mathematics, philosophy and literature as well as in ‘mechanical arts’, influenced in part by the French ‘Polytechnique’ tradition with its strong emphasis on mathematics and mechanics. Unlike the craftsman-engineer who believed in trial and error, hands on education, the engineer- scientist believed that machines could be created and designed using scientific principles guided by rigorous mathematics.

Reuleaux is remembered today as one of the principal founders of modern kinematics of machines. *Kinematics* is the study of *pure motion* in machines without reference to forces. Classical theory of machines had roots in the Greek and Roman description of *simple machines*; the lever, wedge, screw, pulley and wheel. The focus of this ancient theory of machines was not on motions, but on overcoming large forces. This was a time when animal and human labor were principal sources of energy. By the end of the 18th century, the steam engine was more than a half a century old and French thinkers re-defined the machine as a device that transformed *motions* as well as forces. Reuleaux's theory portrayed the machine as a chain of geometric constraints between kinematic pairs in which the motion of one link determined the motion of the rest of the parts.

Reuleaux also stressed the importance of *synthesis* in design and the use of topological concepts to enumerate a class of machine elements. In particular he advanced the use of the concept of pure rolling or *centrodes* for description of relative motion between machine parts. He developed methods of *kinematic synthesis* based on this idea of equivalent rolling between moving parts. Reuleaux also clearly enumerated a basic set of '*constructive elements*' in machine design that was largely copied in 20th century texts on machine design. Combining his technical and artistic interests, he espoused an aesthetic in machine design analogous to the optimum design of structures: namely that *an aesthetically pleasing shape in a machine structure will lead to an efficient use of materials*.

Reuleaux believed in the use of demonstration models to express mathematical and kinematic ideas. He built a large collection of 800 mechanism models in Berlin and marketed 350 of them to universities around the world. Unfortunately much of this collection was destroyed during World War II, but some originals and reproductions of these models can be found in the Deutsches Museum in Munich, the University of Hannover, Kyoto University, the technical university in Porto, Portugal, the technical university of Moscow and at Cornell University in Ithaca, New York which has the largest known collection of 230 models. (See Table II.5, Section II.13 for a list of international collections kinematic models.)

Franz Reuleaux's major work in kinematics was first published as a series of articles by the Prussian Society for the Advancement of Industry in 1871–1874 and published as a book in 1875 under the title, *Theoretische Kinematik: Grundzüge eine Theorie des Maschinenwesen*. It was translated almost immediately into English by Professor Alexander B.W. Kennedy of University College London in 1876 under the title, *The Kinematics of Ma-*

chinery: Outlines of a Theory of Machines. It was also translated into French and Italian, such was its impact on the engineering community in Europe. The ideas that Reuleaux presented in this book influenced the field of machine design for a century. A graphical summary of Reuleaux's influence is shown in Figure I.18. His theory of machines was seen as genius by many of his contemporaries and early generations of kinematics theorists into the 20th century.

Reuleaux introduced his *symbol notation*, a language of machines, which extended the ideas of Charles Babbage, one of the pioneers of computer science. His sequence of kinematic constraints in a mechanism became a sequence of symbols, each representing a unique geometric constraint. Thus a mechanism became a 'word' and a complex machine a connected sequence of symbols, i.e. a sentence of 'words'.

Reuleaux's principal philosophical question in his theory of machines was; how did the machine and its mechanisms come into the mind of the inventor? In the Introduction to his book he wrote,

What is left unanswered is however the other, immensely deeper part of the problem, the question: How did the mechanism, or the elements of which it is composed originate? What laws govern its building up? Is it indeed formed according to any laws whatsoever?

To this question Reuleaux quoted Newton and Göethe and commented that both the machine inventor and the artist must use similar mental processes; "*art and science flourish together in the same soil*". Reuleaux believed that there were logical processes to machine invention and that his ideas of kinematic chains of element pairs and topological expansion of a class of mechanisms were key tools in this logical process. "*I believe I have shown, —, that a more or less logical process of thought is included in every invention*".

In addition to having major industrialists such as Siemens and Langen as friends, Reuleaux produced some famous students such as Lilienthal of glider fame, Mannesman, Linde and Junkers who later became a major airplane producer. Reuleaux can also take some credit for driving a student to fame outside of engineering, namely the American photographer Alfred Stieglitz. Sent by his New York father to study mechanical engineering with the famous Berlin engineer, Stieglitz found Reuleaux's lectures so boring and that he quit engineering and took up the study of photography.

Franz Reuleaux was one of the optimists of the machine age who believed in the power of technology to free mankind from the slavery and prejudices of peasant life, in spite of the terrible toll on the industrial worker. In his time, machines were viewed with awe and marvel. He and his generation saw the

KINEMATICS THEORY NETWORK

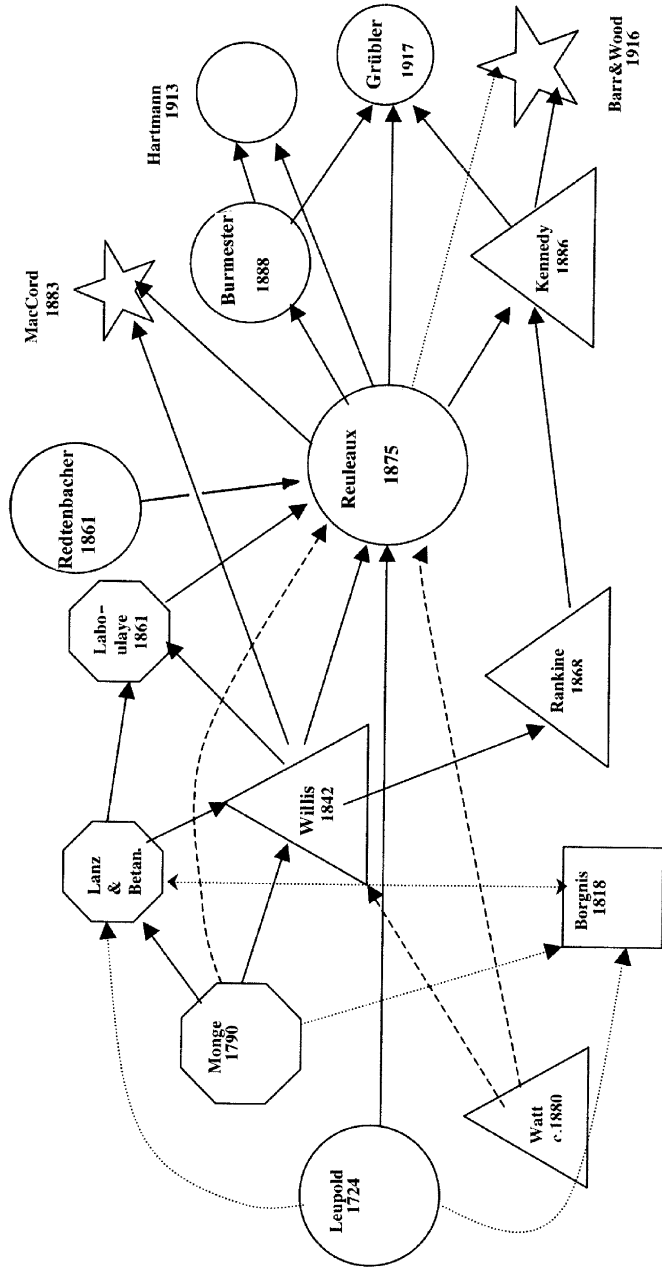

Figure I.18. Influence network of Franz Reuleaux in the 19th century related to the kinematics theory of machines

Age of the Machine as a continuity of progress reaching back to the Greeks and Egyptians as part of the destiny of humankind. Machines were the embodiment of man's knowledge and control over nature. He viewed the evolution in the development of the machine as an analog to the development of advanced societies in which education, crafts, manufacture and government are linked in a chain of mutual dependency for the common good (Reuleaux, 1885).

Reuleaux's life spanned the period of enormous growth in travel spurred by the development of powerful steam engines that carried people across oceans and continents by steamship and railroad. He traveled to World Exhibitions in London (1862), Paris (1867), Vienna (1873), Philadelphia (1876), Sidney (1879), Melbourne (1881) and Chicago (1893), often as German ambassador to these fairs. His professional life coincided with new communications such as overseas mail and the telegraph that linked the growing industrial world with the first Internet.

Reuleaux was a player in the political world of the machine age. One of his most famous roles was as the German ambassador to the Centennial Exhibition in Philadelphia in 1876. In his official duties at Philadelphia he sat on judging panels and wrote articles on industrial advances exhibited at the Exposition. These articles were published in Berlin newspapers and appeared as a book, *Briefe aus Philadelphia* (1877) or 'Letters from Philadelphia'. He called the German manufactured goods at the Fair 'cheap and shoddy' (*billig und schlecht*) compared to British and American manufacturing. In this book he proposed an economic design principle; *when faced with competition, one should raise the quality, not lower the price*. Though he faced criticism for his remarks at home, this principle later became a hallmark of German manufacturing. Later at the 1893 Columbian Exposition in Chicago, Reuleaux was questioned by reporters from several technical magazines as to whether German manufacturers had improved over his 'billig und schlecht' description of 1876. He proudly responded that German goods were quite good but that the Americans had continued a lead in precision manufacturing, to which he was widely quoted in the American press and again criticized at home.

As mentioned above, Reuleaux believed there were scientific principles behind invention and the creation of new machines or what we call *synthesis* today. He attempted to posit principles of *design theory*, a subject that has come into vogue a century later. This belief in the primacy of scientific principles in the theory and design of machines became the hallmark of his worldwide reputation particularly in the subject of machine kinematics. His views also gained him critics, who believed he had placed too much empha-

sis on theory and not enough on engineering practice. After his death these critics tried to reverse the educational structure Reuleaux had helped to build in German engineering institutions.

In recent decades there has been increasing interest in artificial intelligence, synthesis and creativity. Reuleaux's works contain many early ideas about machine invention and synthesis, machine aesthetics, design principles, modular elements as well as best practice rules for design. He viewed his kinematic ideas as prefatory to a theory of scientific invention of machines. He also referred to "*general laws of invention*". He compared creative thinking to the motion of links in a machine, a process governed by logical rules.

Essentially invention is nothing less than induction, a continually setting down and therefore analyzing of the possible solutions which present themselves by analogy. The process continues until some more or less distant goal is reached. (*Kinematics of Machinery*, 1876, p. 52)

Reuleaux's general interest in the history of invention is exhibited in an eight volume series that he served as editor, *The Book of Inventions* (*Buch der Erfindungen*) a pictorial, popular book on the history of invention from the early Egyptians to the end of the 19th century (Reuleaux, 1884). He did not accept the contemporary theory of invention as resulting from scientific discovery, a view that is often expressed in popular literature on technology in the United States. Nor did he believe in the discontinuous genius theory of invention, where the 'hero' inventor, working alone, makes an important advance that benefits humankind. He viewed both scientific discovery and technical invention as evolving from a tension between the two, sometimes within the same man. Reuleaux viewed the development of new machine technology as one of *evolution*, that every invention has had a close antecedent developed further by clever inventors, new scientific ideas and the pressure of marketplace competition. These ideas have appeared anew in recent books on history of technology and technical creativity.

Both Leonardo da Vinci and Franz Reuleaux spent a substantial part of their careers in the study of machines. There are some quotes in da Vinci's notebooks that speak of his passion for invention. But given his wide interests from painting to optics to anatomy we do not really know if he had a passion for machine design or whether he looked on engineering as simply a means to earn funds so he could devote time to his other scientific and artistic interests. Certainly some authors of books on Leonardo tend to draw that conclusion.

For Reuleaux, who himself had interests in art and anthropology, the study of machines was a passion for him. A few quotations of Reuleaux illustrate his 19th century philosophic and romantic view of The Machine. In describing the consequences of the idea that all relative motions of machine elements can be reduced to rolling, he wrote: *“the machine becomes instinct with a life of its own through the rolling geometric forms everywhere connected with it, – mechanisms carry on “the noiseless life-work of rolling”, – “they are as it were the soul of the machine ruling its utterances – the bodily motions themselves – and giving them intelligible expression. They form the geometric abstraction of the machine”.*

On Franz Reuleaux’s death in 1905 at the age of 75, the American Machinist, published in both New York and London wrote a lead column in its September 14th issue:

By the death of Prof. Dr. Reuleaux the engineering world loses one of its truly great men. Not merely was Prof. Reuleaux great in the sense of being an expounder of mechanical science and a teacher of it, but along with and above that he was a man of singular nobility of purpose and was actuated by the broadest and highest conception of his duty to himself and mankind. – The benefit to mankind resulting from the life and work of Prof. Reuleaux is simply incalculable: his reward is in a modest competence and an undying fame. Many a Wall Street operator, gambling in the things produced by aid of Prof. Reuleaux’s work makes more money in a day that Prof. Reuleaux accumulated in a lifetime. — To many engineers in the United States he was a warm friend and by all was accepted as an exponent of what he himself called the union of science and practice in the art of the mechanical engineer.

I.6 INFLUENCE OF LEONARDO DA VINCI ON 19TH C. MACHINE THEORISTS

Did Leonardo da Vinci influence engineers and inventors in the 19th century Age of Machines? Did other Renaissance machine engineers such as Francesco di Giorgio Martini have any impact on machine design in the industrial age? For nearly three centuries Leonardo's manuscripts were in private and royal libraries. His thousands of separate folios were sorted and resorted, cut and pasted into several Codices now housed in Milan, Paris, Madrid, London and several other locations including Bill Gates home in Washington State, USA. However, the principal manuscript collections that pertain to machines and mechanisms are the *Codex Atlanticus* in the Biblioteca Ambrosiana in Milan, the *Codex Madrid* in the National Library Madrid, Spain, and the *Manuscripts A–M* in the library of the Institut de France in Paris.

Construction of machines in the early 19th century industrial revolution was primarily carried out in guild-like workshops, not too much different from that of the Renaissance workshops. These workshops were often run as a partnership of an inventor and entrepreneur as in the case of James Watt and Matthew Boulton in their building of steam engines in the late 18th century or Nicolas Otto and Eugen Langen and their internal combustion machines three quarters of a century later. The historical record shows that most inventors had little or no formal training in the sciences or technology, but as a group had a keen interest in new scientific ideas. For example, in a new book on James Watt and his contemporaries (Ugnow, 2002), Watt is said to have learned German in order to read the *Theatrum Machinarum Generale* of Leupold (1724). Some of Leupold's drawings are very similar to the 15th C. work of Francesco di Giorgio Martini. Thus the work of Francesco di Giorgio may have had indirect impact on machine design in the 18th century especially the development of mechanisms for the steam engine.

Most of these new machines however developed out of earlier technologies and in the late 18th and 19th centuries it is unlikely that someone read a book about a machine invention of Leonardo and decided to build it. As Reuleaux noted in his theory of invention, inventors generally observed what was already built, absorbed some new scientific and mathematical ideas, imagined a new application or more demanding performance or economic specifications and then created a new machine. Thus if it is unlikely that Industrial Age engineers were directly influenced by Renaissance engineers, who in the technical world of the 19th century might have been influenced by Leonardo and his contemporaries?

As new machines emerged in the 19th century from inventors and entrepreneurs, another group of engineers were developing a theory of machines based on mathematics and science. It is amongst this group of theorists that there is evidence that Francesco di Giorgio Martini's and Leonardo da Vinci's drawings may have contributed to the science of machines if not to the actual invention of new machines in the Industrial Revolution.

The Age of Enlightenment in the late 18th century, as well as the political revolutions in North America and France, coincided with a renewed interest in Leonardo's art and manuscripts. The defeat of the Lombard Italians by Napoleon's forces led to the removal in 1796 of Leonardo's manuscripts from the Ambrosiana Library in Milan to Paris, an echo of an earlier defeat of Leonardo's patron by Louis XII. An unintended consequence was the study of these manuscripts by scholars in Paris. In 1796 Giovanni Battista Venturi, professor at Modena, studied Leonardo's notebooks in Paris and wrote a work entitled, '*Essai sur la ouvrages physico-mathematiques de Leonard de Vinci*'. Venturi is known for his scientific work in hydraulics and the flow of fluids. Trained in Italy in divinity studies he had the background to unravel Leonardo's reverse writing in Italian. His work brought attention to Leonardo's scientific studies that inspired other scientific and mathematical scholars in the second half of the 19th century to examine the manuscripts long neglected in Milan.

Another element in the link between Leonardo and Reuleaux is the writing of French mathematician Chasles in 1837 and Guillaume Libri in 1840. Chasles published a history on methods in geometry in which he mentions an ellipse-drawing mechanism of Leonardo da Vinci, citing of course the essay of Venturi. The Italian Libri wrote a long history of mathematical sciences in Italy in 1840, but he had direct access to Leonardo's manuscripts in Paris. Hart (1961) relates how scholars suspect that Libri stole a section of the Leonardo *Manuscript B* in 1848 and took it to Italy where he sold them in 1867. The manuscript later ended up in the University of Turin. Libri does not have much discussion of Leonardo's machines except to say that he had worked on many sciences as well on mechanics and machines. But Libri's work may have inspired Grothe's study of Leonardo's machines.

The first published facsimiles of Leonardo's notebooks occurred in Paris with the facsimile of the French held Notebooks A–M in 1880 and the facsimile of *Il Codice Atlantico di Leonardo da Vinci* in Milan in 1894–1904, edited by G. Piumati. However there were a number of excerpts of the Notebooks published earlier, such as folios related to the flow of water, released in Bologna in 1828 and a collection of individual folios published in 1872 in

Milan under the title *Saggio delle Opere di Leonardo da Vinci Tavole tratte dal Codice Atlantico*. (See V.P. Zubov, 1968, for a history of the facsimiles of Leonardo's works.) It is perhaps this work that Grothe had access to.

In 1873, Hermann Grothe [b. 1839] of Berlin wrote a series of articles on Leonardo the inventor, in which he cited references to Leonardo's work by the Italian Alessandro Cialdi (1873) who had 24 photographic tables of Leonardo's drawings. Grothe also refers to a Michel Alcan who wrote about a 'scheermachine' of Leonardo in 1870. As a historical note, Grothe, ten years younger than Reuleaux, had attended the Philadelphia Exposition in 1876 as a German trade representative and later wrote an extensive review of American manufacturing technology. Reuleaux was also at Philadelphia as German ambassador to the Exposition. Thus it is likely that these two Berliners were in close contact and that Reuleaux knew of Grothe's research on Leonardo's machines.

There may be evidence that Leonardo's machine drawings may have had some influence on German theoretical engineers such as Franz Reuleaux in the late 19th century, but there is no evidence that his Notebooks, nor the essay of Venturi had any influence on the professor-engineers and students of the Ecole Polytechnique in Paris around in the early 19th century. If Leonardo's work had any impact, it would have been cited in the books of Gaspard Monge, Jean Hachette, or Lanz and Betancourt.

The late historian Eugene Ferguson (1962) wrote that the origins of the Ecole Polytechnique stemmed from the military school in the old city of Mezieres northeast of Paris. Lazare Carnot, Gaspard Monge and Jean Hachette all came from Mezieres to Paris to organize a new curriculum in the theory of machines. Jean Nicolas Pierre Hachette [1769–1834] was a junior member of Monge's department of descriptive geometry upon which the new science of machine kinematics was built. Monge however was called to serve in Napoleon's campaign in Egypt and Hachette was left to design a curriculum in machines that was first offered in 1806. The text for this course was published in 1811 under the title, *Traite elementaire des Machine*. This was an influential book and was even used in the US Military Academy in 1824 or earlier. Hachette's theory of mechanisms was based on the conversion of one type of motion to another and attempted to categorize machines in this manner. Two Spanish students at Ecole Polytechnique published an even more popular book, using Hachette's ideas. Phillipe Louis Lanz and Augustin de Betancourt's work of 1808 was translated into English under the title *An Essay on the Composition of Machines*.

In neither Hachette's work nor Lanz and Betancourt's book is there mention of Leonardo da Vinci or Venturi's essay of 1797. Today this would not be unusual because technical authors normally cite only recent scientific work. But in the 19th century, it was common for authors to review the history of the subject, often over several centuries from the late Renaissance to the early 19th century. For example in Hachette's textbook on machines he references the machine books of Besson (1578), Ramelli (1588) and Leupold (1724). However Leonardo's work is not cited. In 1830, Hachette published a book on the history of the steam engine, *Histoire des Machine a Vapeur* in which he mentioned the ancient Greek and Roman contributions of Hero of Alexandria and Vitruvius as well as the Renaissance engineer Roberto Valturio (1472), but there is no mention of Leonardo's use of steam to drive a vertical shaft turbine wheel that drove a roasting spit, a device often cited by modern authors writing of Leonardo's inventions.

The book by Lanz and Betancourt had a detailed tabular classification of mechanisms and machines based on the change of motion from say rotary to translation or rotary to intermittent motion. In the 158 pages of the English translation, the authors cite well-known machine books of Besson (1578), Ramelli (1588), Strada (1617), Branca (1629), Böckler (1661); but not Leonardo. The most referenced work in Lanz and Betancourt was the treatise of machines book of Leupold (1724). The da Vinci scholar Ladislao Reti (1963) had traced the copying of machines in the machine book of Francesco di Giorgio Martini through the 16th, 17th and 18th centuries to Leupold (see Sections II.8 and II.9). Thus we can claim that di Giorgio's machines may have had evolutionary influence on machine theorists in the Ecole Polytechnique and by inference on the British machine theorist Robert Willis as well as Reuleaux's teacher, Ferdinand Redtenbacher in Karlsruhe.

An Italian named Borgnis published a machine classification book in (1818) that added a further six categories or orders to the classification scheme of Lanz and Betancourt with ideas such as *recepteur or regulateur*. Reuleaux also cited this work. But again Borgnis offers no reference to Leonardo. By mid century, the leading theoretician in the theory of mechanisms was the Englishman Robert Willis [1800–1876] who became professor at Cambridge University lecturing on the subject of kinematics of machines. Again there is no reference to Leonardo's machine drawings.

The evidence is clear, that although there were a few published works on Leonardo's machine drawings in the early 19th century, they apparently did not influence the thinking in machine theory in the first half of the 19th century.

Specific discussion of Leonardo's work on machines emerged some 80 years after Venturi's essay in the work of Hermann Grothe of Berlin in 1873 and 1874 who published a series of articles on 'Leonardo Engineer and Philosopher'. Grothe surveyed the earlier work of Venturi on Leonardo. He also cited a paper by Franz Reuleaux on a machine to draw ellipses attributed to Leonardo. Reuleaux created a model entitled 'Leonardo Oval work' in his kinematic model collection based on a double slider mechanism. In describing the ellipse-drawing machine of Leonardo, Reuleaux (1876a) cited the 1837 book of Chasles who had written a history of mathematics. Grothe also mentioned an encyclopedic work of Professor Karmarsch [1803–1879] of the Technical School in Hanover on the history of technology in which some of Leonardo's work on machines was reviewed. Grothe's monograph highlighted a number of basic mechanisms drawn by Leonardo and compared them to the division of machine elements published by Jacob Leupold a century earlier in 1724 (Figure I.19).

Concerning the influence of Leonardo's work on Reuleaux, Grothe provides evidence that Reuleaux was aware of at least some of the machine drawings of Leonardo. In the Preface to his book, Grothe thanked Reuleaux for reviewing the book before publication. He also referred to a collection of Leonardo's drawings and photographs based on the French and Milan codices that were brought to the Royal Industrial Institute in Berlin around 1869–1873. Reuleaux was Professor and Rector of the Royal Industrial Academy in Berlin at the time. Reuleaux's important book on the *Kinematics of Machinery* contains long discussions about the evolution of machines and mechanisms however his only mention of Leonardo da Vinci is in connection with the 'ellipsograph' mechanism. The spirit of Reuleaux's book placed his new theory in a wider context of technical history including references to 16th century machine books. It is not inconceivable that Reuleaux's review of Grothe's manuscript on Leonardo might have reinforced his ideas about evolution of machines and the deconstruction of machines into basic mechanisms.

At the end of the 19th century, several collections of da Vinci drawings and facsimile editions began to appear (see e.g. Zubov, 1968, 2002; pp. 294–296). A facsimile of the Paris Codices was printed in Paris between 1881–1891. The *Codex Atlanticus* was printed in facsimile in Milan between 1894–1904, with excerpts appearing as early as 1872.

In 1899, Theodor Beck of Darmstadt published a German book with a title translated as '*Contributions to the History of Mechanical Engineering*' containing analysis of dozens of mechanisms from Leonardo manuscripts with more than a hundred drawings based on Leonardo's sketches in the volumi-

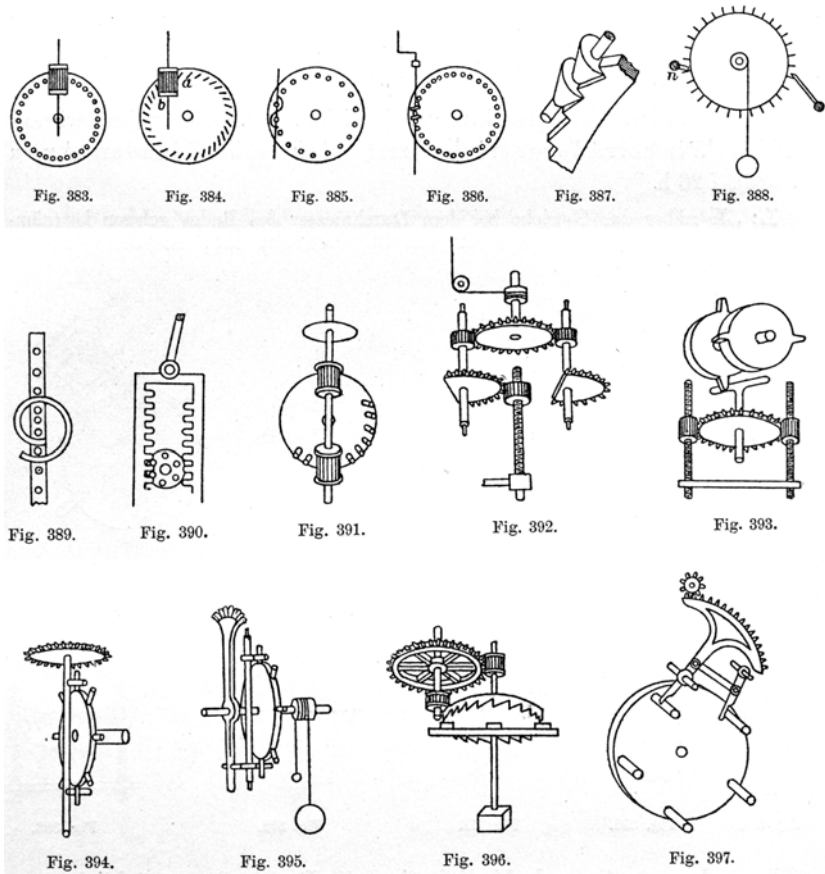

Figure I.19. Compilation of machine elements of Leonardo da Vinci by Theodor Beck (1899) after Grothe (1874)

nous *Codex Atlanticus* as well as the newly translated *Manuscripts A–M* in Paris. Finally in 1922, 17 years after Reuleaux’s death, Franz M. Feldhaus published a work describing Leonardo da Vinci as an engineer and inventor. Until Ladislao Reti’s comparison of Leonardo’s ‘elementi macchinali’ with Reuleaux’s ‘constructive elements’ of machine design in 1963, the work of the Germans, Grothe, Beck and Feldhaus formed the major interpretation of Leonardo’s machine drawings with the modern age of machines.

To return to our question as to Leonardo’s influence on 19th century machine design, by the time that scholars such as Venturi and Grothe had published interpretations of Leonardo’s work, the pace of technology was in full gear and had surpassed most of the advances recorded and invented by Leonardo in the Renaissance age of machines. Most of those advances

were passed on through the guilds and the encyclopedic ‘theatre of machines’ books that were published in the 16th, 17th and 18th centuries. (These books are discussed in Section II.9 of this book, as well as in Part IV; see also Table II.4.) The development of new materials in the 19th century such as high strength steel had also changed the way in which basic machine components were designed and manufactured which was dramatically different from the Renaissance age of machines. Still it is likely that *ideas* about the decomposition of machines into basic components, espoused by machine theorists such as Reuleaux, were reinforced by the newly discovered machine drawings of Leonardo in the 19th century.

One area where there may have been direct influence on the design of machines was in the field of flying machines. One of the pioneers of flight Otto Lilienthal was a student of Franz Reuleaux in 1867 at the Royal Industrial Academy in Berlin (Königliche Gewerbe Akademie) six years before Grothe wrote his reports on Leonardo’s machines and at a time that Grothe recorded that a collection of notes and sketches of Leonardo were brought to the Institute. Drawings of wing flapping mechanisms by Lilienthal for flying machines have many of the kinematic elements found in Leonardo’s manuscript drawings on flying as is illustrated in the discussion in Section II.19 below.

In summary we reiterate a theme of this book once again; although we have no direct evidence for specific inventions of Leonardo being copied in the Industrial Age of machines, the evidence for the evolutionary influence of Renaissance machine engineers through guilds, workshops, and mutual copying from the famous ‘theatre of machine’ books of the 16th, 17th and 18th centuries is compelling. This thesis will be discussed in greater detail in Part II of this book.

I.7 KINEMATICS OF MACHINES: THE GEOMETRY OF MOTION

Aristotle and early machine theorists such as Archimedes, Hero and Pappas, described the *simple machines* in terms of a balance of forces or what is technically called equilibrium or statics. The *lever*, *screw*, *pulley*, *inclined plane* were analyzed in terms of the force advantage that these components could provide in machines to amplify human and animal muscular power. Although one can still find this approach to machine theory in elementary physics books, the modern view, culminating in the pioneering work of Franz Reuleaux, was the geometric description of machines in terms of a set of mechanisms. This concept is based on the fact that the motion of one link in the mechanism determines the motion of all the other links in the kinematic chain. For example the circular motion of the pedals in a bicycle determines the angular velocity of the sprocket and the chain, which in turn, through the gear train, determines the forward speed of the bicycle and the rider.

The geometric relationship between the motions of all the connected parts in a machine is the subject of kinematics. The French term *cinématique* (from the Greek word for movement) was introduced in 1838 by André-Marie Ampere in his classification of the sciences. (A classic, short history of kinematics is the very readable report of the late historian Eugene S. Ferguson (1962), that can be found on the KMODDL website of Cornell University Reuleaux Kinematic Models; <http://kmoddl.library.cornell.edu>.) Although kinematics of machines was still in an infant state during the Renaissance, a reading of the *Codex Madrid* of Leonardo da Vinci shows that he was as much concerned with the geometry of motion in machines as with the state of forces in his mechanisms.

In discussing kinematics in the 15th century, one has to remember that many basic concepts pertaining to motion of particles, rigid bodies and fluids had not matured. This includes concepts of velocity, acceleration, angular rotation, composition of motions, the use of coordinates in space and time, as well as the graphical representation of motion. Concepts such as average velocity were discussed by the 13th and 14th century Schoolmen such as those at Merton College. However, the mathematical tools of differential and integral calculus would not be discovered until the time of Newton and Leibniz in the late 17th century. In contrast, during Reuleaux's career in the late 19th century, mathematical kinematics and dynamics reached sophisticated heights especially in the work of Lagrange and Hamilton in dynamics. Thus Reuleaux's contributions to the kinematics of machines were at a more advanced level than those of Leonardo.

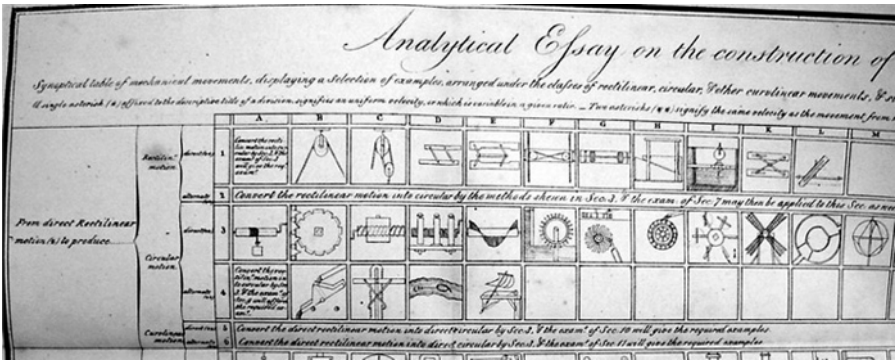

Figure I.20. Table of kinematic motions from Lanz and Betancourt (1809) after Hachette, Ecole Polytechnique

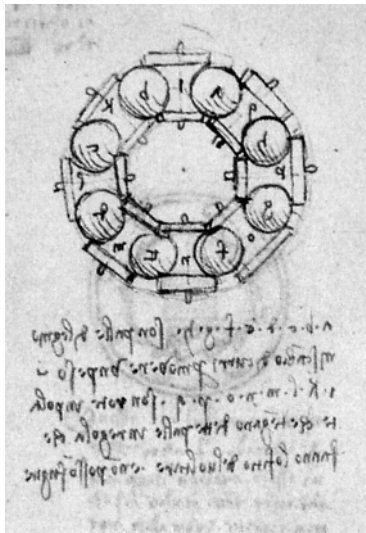

Figure I.21. Sketch of anti-friction ball bearing of Leonardo da Vinci (Codex Madrid I, Folio 20v)

The recognition that kinematics was of equal if not paramount importance in machines *vis-à-vis* forces and stresses arose in the work of a group of engineers and mathematicians at the Ecole Polytechnique in Paris led by Gaspard Monge (1795) in the late 18th century. At this time the emergence of the steam engine had triggered a plethora of mechanical inventions and many researchers sought a rationale to try to bring some ordering principle along the line carried out in biology by Linnaeus in 1735 and later in chemistry by Mendeleev in 1869. Many classification schemes were proposed which were based on the idea of the machine as a device that transformed motion,

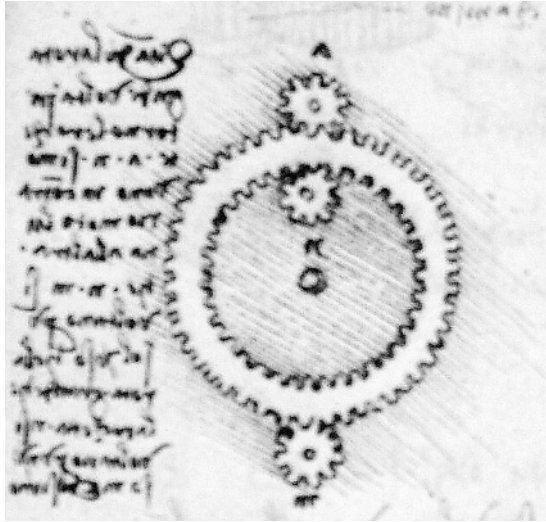

Figure I.22. Sketch of planetary gear mechanism of Leonardo da Vinci (*Codex Madrid I*, Folio 13v)

from say circular to rectilinear or from linear to intermittent etc. One of these classification tables is shown in Figure I.20.

Many drawings of kinematic mechanisms can be found in Leonardo's *Codex Madrid*, such as the lever, screw, pinions and toothed wheels, escapements, linkages and belt mechanisms. For example consider the so-called 'ball bearing' of Leonardo shown in Figure I.21, Folio 20v. From the top view it appears as a modern set of steel balls supported by an inner and outer race. However the accompanying text reveals a more complicated device:

a b c d e f g h b are wooden balls, rather than rollers are used to support a weight. **i K l m l n o p q** wheels provided with axels that keep the balls in place so that the balls turn but are unable to escape.

Here Leonardo describes a thrust bearing, not the usual radial ball bearing in modern machines with a similar geometry. He clearly understands the role of different elements in the mechanism in providing constraints so that the mechanism will perform the desired motion.

In another example from the *Codex Madrid*, Folio 13v, he describes the motion of a planetary gear with inner planet pinion **n** and outer planet pinions **a, m** (Figure I.22):

When the big wheel revolves, pinions **a** and **n** will turn in motion contrary to each other. And pinions **n** and **m** will turn in the same

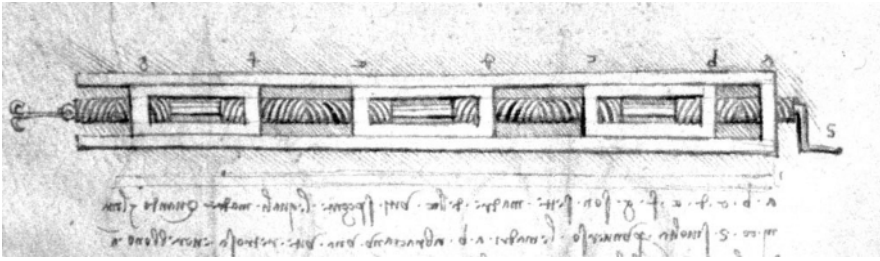

Figure I.23. Sketch of helical screw mechanism, Leonardo da Vinci (*Codex Madrid I*, Folio 57v)

direction just as the big wheel and pinion **a** will turn in the same direction.

Critical assessments of Leonardo’s contributions to theoretical mechanics by Pierre Duhem (1906) and Clifford Truesdell (1968) report that Leonardo did not derive any general principles of mechanics from either his own experiments or mathematical reasoning. They both credit da Vinci with a talent for keen observation and accurate representation of mechanical devices and biological specimens. Throughout the notebooks Leonardo wrote short statements about some philosophical or scientific observation. Both critics however point out that for every aphorism apparently reflecting some fundamental principal discovered centuries after Leonardo, one can often find another espousing a contrary position. The most convincing writing of Leonardo da Vinci however is that accompanying some drawing of a real or imagined machine object. Consider for example the drawing of a shaft with alternating helical screws, Folio 57v. (Figure I.23) Here he is able to generalize from one specific case to another as in the following quotation:

–**a b c d e f g** are the seven nuts of the disjointed screws. When crank **S** turns in one direction, nuts **a b** which surround an inverted screw, would be inclined to move closer to one another. But since **a** is stationary, the screw, by necessity, must move toward this moveable nut. And the same occurs in the case of nut **b**. Consequently, at an entire turn of the crank, the nut must necessarily proceed by a length equal to two teeth of the screw, and the nut **c** will cover the same distance. Therefore, the screws of nuts **c** and **d** will travel to a length corresponding to 3 teeth, and so forth, with the result that as all the inverted screws have completed one single revolution, the last screw will have moved by a distance equal to 7 teeth because there are 7 nuts altogether.

CONCEPTS OF KINEMATIC PAIRS AND KINEMATIC CHAINS

The idea of a mechanism as a kinematic chain of links, each with geometric constraints with a neighboring link was advanced by the Cambridge professor Robert Willis in his 1841 book on kinematics of machines. Reuleaux's kinematics book of 1875 brought these ideas to maturity with the concepts of *kinematic pairs* and the *kinematic chain* illustrated in Figure I.14. Kinematic pairs also known as 'joints' involve parts that have constrained motion relative to one another. For example, a *revolute joint* involves two parts where one part can rotate about an axis fixed in the other part. A *prismatic joint* is one where one part can slide or translate relative to one another. Pairs with surface contact Reuleaux called *lower pairs* and joints with point or line contact such as gear teeth in contact, he called *higher pairs*. Different pairs have different relative degrees of freedom. For example, revolute and prismatic pairs have one degree of freedom whereas a ball or spherical joint has three degrees of freedom.

A machine or mechanism made up of rigid bodies can be described as a sequence or chain (circuit) of kinematic pairs as shown in Figures I.14 and I.24. Kinematic chains can be open, closed or branched. Each body is called a link in the chain. Links can have one or more joints between other bodies in the mechanism. Usually one of the links is fixed or grounded. Many mechanisms of the 15th and 19th centuries were closed chains, such as the mechanisms shown in Figures I.3a and b. However a pendulum in a clock is an open link chain. Today most robotic arms involve open link kinematic chains as in Figure I.9. Both Renaissance and Industrial Age engineers used non-rigid links such as springs or elastic beams as well as cables and belts. Reuleaux envisioned the steam or gas in a cylinder as a non-rigid fluid link.

Reuleaux also introduced the idea of non-ideal constraints in machines that he called *force-closed* machines. An example is the rolling contact between a wheel and the road or a wheel and a rail. The contact is enforced by the force of gravity, i.e., the constraint is *force-closed*. However accelerations of the wheel can break this constraint and the rolling constraint will be lost. Revolute, prismatic and screw joints ideally cannot be broken by accelerations. He also believed that the history of the evolution of mechanisms was the replacement of force-closed or incomplete machine pairs by kinematic or geometry-closed constraints, that led to more precise machines.

One of the constructs in mechanism design that evolved from these concepts was the *mobility* or degrees of freedom in mechanisms. For example, given a set of n links or bodies and m joints, how many degrees of freedom will the machine have? In an automobile one requires three degrees of free-

dom, in a robot manipulator arm one wants at least six degrees of freedom. In a hinged door or the control flap on an aircraft we often want only one degree of freedom. Another question is; given a set of links and joints how many different mechanisms can one create from the different combinations of links and joints? These questions opened up a set of topological questions of machine design that developed from the ideas of Franz Reuleaux that we discuss in the following section.

There is no evidence that the work of Leonardo da Vinci had any influence on the concept of the kinematic chain even if the principal kinematic theorists such as Monge, Willis or Reuleaux had had complete access to the Notebooks of Leonardo. Leonardo's work does show a shift in the 15th century to an interest in *motions* in machines as contrasted with *forces*. And he deserves credit for recognizing the existence of basic machine elements in the synthesis of machines. Thus Leonardo's drawings of machine components often show combinations of kinematic pairs, such as gear teeth in contact or elements of chains. This idea evolved into the later drawings of Leupold (1724) that many theorists such as Willis and Reuleaux had used for reference. But it was Reuleaux and his contemporaries in the 19th century that formalized the idea that mechanisms are essentially described by a circuit of geometric constraints (Figure I.24). It is Reuleaux's generalization of this idea to include a whole family of mechanisms under one chain of kinematic constraints that is unique to the late 19th century.

A summary of Reuleaux's general contributions to kinematics are:

- (i) the definition of a machine as a chain of constrained elements;
- (ii) the idea that machine evolution has progressed from forced-closed mechanisms to more precise chains of kinematic-pairs;
- (iii) the recognition that each element in this chain can be understood by looking at the constraints between kinematic pairs;
- (iv) the search for a principle of logical synthesis of kinematic mechanisms and his use of a symbolic syntax to classify machine mechanisms;
- (v) the use of instant centers or rolling centrodes to represent the relative motion of two kinematic pairs of machine elements.

The last concept is a little obscure but is a beautiful idea. Reuleaux wrote that the general planar motion of any two bodies could be represented as if one body is rolling on another, whether they are constrained or not. Reuleaux may have been the first to provide a systematic discussion of this fact. For each of the moving bodies he derived a path of instant centers or pole-paths (*Polbahnen*, in German, translated at first by Kennedy as *centroid*, who later changed the name to *centrode*). The fact that every constrained motion of a

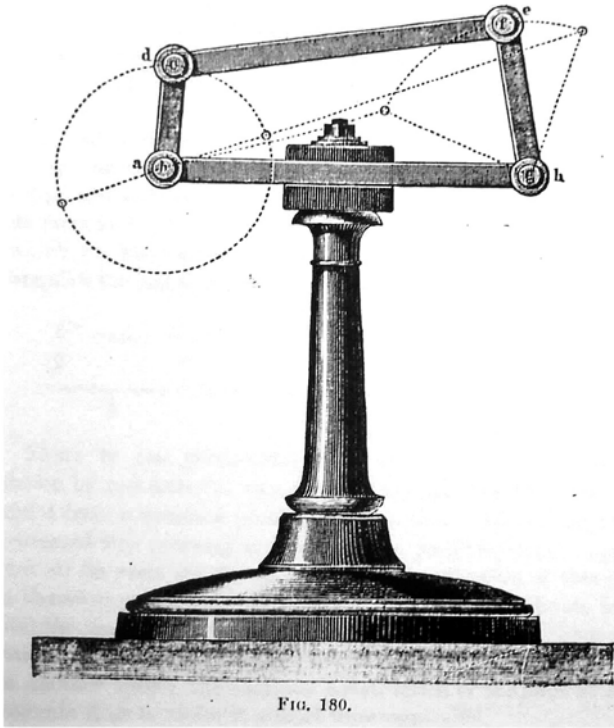

FIG. 180.

Figure I.24. Kinematic chain for a four-bar mechanism (Reuleaux, 1876a)

kinematic pair is equivalent to rolling, and the idea that a machine is a chain of such kinematic pairs, led Reuleaux to redefine the machine, perhaps with tongue in cheek, as a collection of objects in which *everything rolls*.

The geometric nature of kinematics of machinery is made very explicit in Reuleaux's book through the use of particle paths and *Polbahnen*, in which some point on one of the links in the kinematic chain is made to trace out a curve in space as the mechanism is moved through one cycle (Figures I.25 and I.26). For example, the rolling of a small circle or gear on a larger circle will trace out curves called epicycloids. These curves were extremely important in the description of planetary motions in the pre-Copernicus or Ptolemaic geocentric theory of the solar system in the time of Leonardo da Vinci. Aside from their historical importance however, the path points associated with kinematic motions of mechanisms can be quite beautiful as illustrated in the curves in the figure below from Reuleaux's 1876 *Kinematics of Machinery*. These curves are an explicit manifestation of the definition of *kinematics* as the geometry of motion.

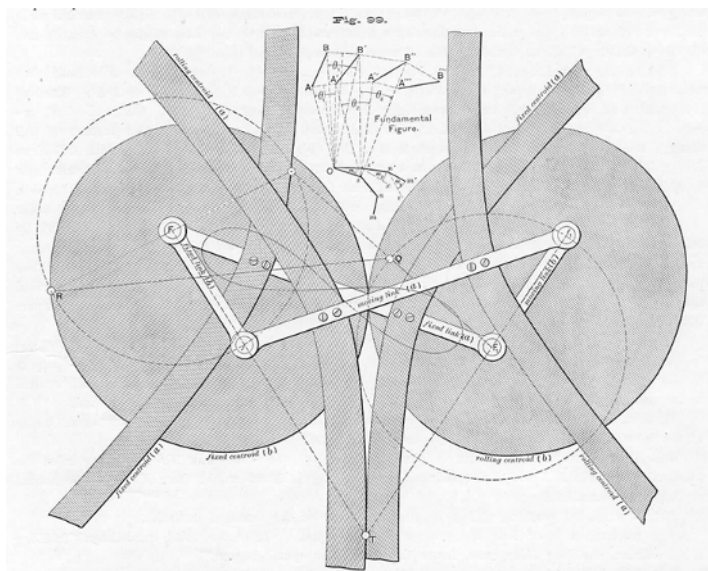

Figure I.25. Centroides or rolling curves for a four-bar mechanism (Willson, 1898)

PLATE VIII.

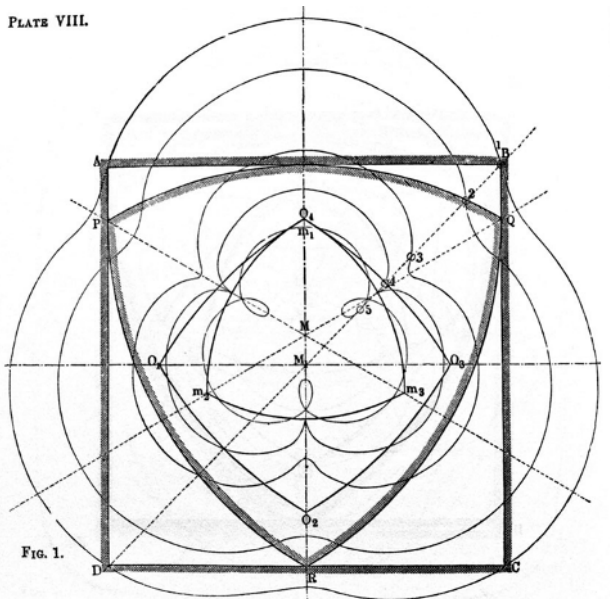

Figure I.26. Path points of motion of a Reuleaux triangle in a square bearing (Reuleaux, 1876a, plate VIII, figure 1)

DYNAMICS VERSUS KINEMATICS OF MACHINES

In modern books on mechanics, there is a distinction made between kinematics and dynamics. Kinematics is the description of motion generally with the mathematics of geometry and differential calculus. Dynamics on the other hand treats the behavior of matter under forces governed by the dynamical laws of Newton and Euler. Dynamical laws of physics apply to machines as well as to orbiting planets and satellites. For example, the motion of the pendulum in a clock is governed by the force of gravity and its period is determined by the differential equations representation of Newton's laws of gravity and inertia.

Although Reuleaux's theories about machines were important contributions at the time, his theories were based largely on geometric ideas (or what Reuleaux called *Phoronomy*) and not on dynamic principles that were later incorporated into the theory of machines. Nor did Reuleaux treat the problem of rolling bodies and so-called *non-holonomic constraints*. Modern texts on multibody dynamics and robotics treat both kinematics and dynamics in a systematic way. These dynamic theories however, view the machine as a deterministic entity whose behavior could be uniquely predicted and controlled by use of the Newton's laws of motion. The distinction between kinematics (governed by geometry) and dynamics (governed by laws of physics) was not known in the Renaissance of Leonardo and his contemporaries. Leonardo da Vinci knew however that geometry was important to the study of machines.

Recently there have been new discoveries in dynamics under the mantle of '*chaos theory*', (see e.g. Moon, 1992). Modern engineering scientists have discovered that many machine mechanisms can exhibit small amounts of unpredictable or chaotic dynamics due to the inevitable imperfect nature of the machine as constructed, including friction, backlash and elastic flexibility. Examples include chaos in gears and chaos in ball bearings. This has suggested that a modern theory of machines should admit a certain measure of chaos or even randomness in the behavior and that in some cases this small unpredictability may be beneficial to the successful operation of the machine. The nature of unpredictability in machines was not ignored in the 19th century, especially amongst clock analysts (see e.g. Moon and Stiefel, 2006).

Reuleaux seems to have recognized the fact that unilateral constraints or what he called 'force-closed' constraints, were a source of "*clattering and jerking in their force-closed working*". He said, the scientific designer tries to eliminate unilateral constraints "*until all indefiniteness is removed*". He also acknowledged the problem of determining friction forces in mechanisms, which today are recognized as a major source of chaos in mechanical systems.

The problem of friction in machines was also of concern to Leonardo da Vinci who proposed various bearing concepts to minimize friction loss in machines.

In antiquity and the Middle Ages, machines generally resided in craftsmen's minds only to be realized through the skills of the workshop. In the Renaissance we see the emergence of graphical static representations of machines that have pictures of physical machine elements that can begin to be used to construct working devices, especially in the work of Leonardo da Vinci. In the late 18th century Monge and his Parisian colleagues at Ecole Polytechnique represented the machine with descriptive geometry. By the late 19th century, Reuleaux and his contemporaries reduced the machine to a set of abstract symbolic elements in a circuit. In the 20th century the motions in machines were represented by beautiful mathematical curves, differential equations and topological ideas in the machine designers brain. Today the complex machine exists again as an abstract construct, but now in a multi-body code in a computer and not in a human brain.

1.8 VISUAL AND TOPOLOGICAL THINKING: REULEAUX'S LANGUAGE OF INVENTION

Written language is a set of icons adopted by a community to codify and transmit information. In contrast to our digital age of binary symbols, information in past millennia was codified in complex pictograms, symbols and alphabets. In the evolution of machines, codification of machine geometry and topology was often represented by graphic pictograms that gained status of a universal '*lingua franca*' of machine design. Examples of common representation of machine elements and kinematic mechanisms can be found in artifacts of ancient Babylonian and Egyptian cultures. This process began with symbols for the 'simple machines' such as the lever, wheel, screw, pulley and inclined plane. By the late Middle Ages and Renaissance, this graphical machine language was highly developed. Complex machines can be found in the 13th century sketchbook of Villard de Honnecourt (also *Wilars de Honecort*) and in the 13th century machine drawings of al-Jazari. By the early Renaissance of 15th century Italy, this art reached maturity in the work of the artist-architect-engineers.

In machine books of the 15th and 16th century one can see the same classes of mechanisms in books by a dozen authors from different parts of Europe. Pumps, endless screws, toothed wheel pairs, chain of pots, clock escapements and many other mechanisms are represented in this universal machine language. In the sketchbooks of Leonardo da Vinci, such as the *Codex Atlanticus* or the *Codex Madrid*, there are hundreds of drawings of gear mechanisms. The shape of the gears and their teeth vary considerably and the applications are many and varied, however there is no mistaking this kinematic pair. Similar machine books appeared in China as in the summary of Chinese technology, *T'en-Kung K'ai-Wu* (1637) or *The Book of Ingenious Machines, Qi Qi Tu Shou* (1627) of the Jesuit Johann Terentius (a.k.a. J. Scheck) and Chinese engineer Wang Cheng that was a translation of several parts of Western machine books. (The Sinologist Joseph Needham (1965) has written an extensive history of Chinese contributions to mechanical engineering.)

The use of pictorial and graphical language as a primary tool for communication of technical information has been advanced by the historian Eugene Ferguson (1977, 1992). In a recent book Arnold Pacey (1999) discussed the importance of both pictorial and diagrammatic visual thinking in science and engineering. The origins of development of a visual language for engineering and science can be found in the early Renaissance. Perspective and drawing to scale became important in communicating both architectural and engineering designs according to Pacey (1999). The historian Alfred Crosby

has made the point that visualization was very important in the development of a new way of scientific thinking. The importance of literal education was challenged by ideas based on visual and abstract non-verbal constructs. (See also Section II.1 for a discussion of kinematic perception and the brain.) The evolution in visual language of machine knowledge took a similar path from literal symbols of gears and wheels beginning in the ancient cultures to more abstract network and circuit symbols of Reuleaux and other 19th century mathematical engineers.

In Western culture, historians often try to assign invention to specific people and the patent system is a codification of this tradition. This has led to claims of copying or plagiarism when similar machine components appear in machine books over the centuries and across many cultural and language groups. But another interpretation is that these so-called 'inventions' arose out of the common language of machines developed over countless generations and are the result of the evolution of a graphical representation of humankind's understanding of geometric, topological, and kinematic constraints between mechanical objects which we call machines.

A similar set of graphical tools is associated with static structures in architecture. The use of geometric constructs such as rectangles, triangles, arcs of circles to represent the built environment of buildings, dams, fortifications, churches mosques, towers etc. also developed over many centuries. It is no accident that major machine designers of the Renaissance such as Brunelleschi, or Francesco di Giorgio Martini were both architects and machine engineers. We can see in the sketchbooks of Leonardo da Vinci hundreds of geometric shapes side by side with renderings of designs for buildings, dams and machines. This connection between machines and architecture can also be found in the 19th century work of the machine theorist Robert Willis of Cambridge who published books on both kinematics of machines as well as the history of construction of British cathedrals. (See also Feldhaus, 1953, and Ceccarelli and Cigola, 2001, for a review of mechanism drawings from the Middle Ages.)

Unlike most architectural objects, machines have a dynamic or kinematic relationship between the solid and fluid material objects that comprise the machine. The graphics must embody geometric constraints such as gear teeth in contact or the rolling of a wheel over a ground plane. The graphical icon or symbol must represent not only the geometric relationship at a particular time, but also the constraints over an entire cycle of positions as in the movement of a pump piston in a cylinder. The use of the term *topological thinking* is meant to capture this idea, which must have developed over many

millennia; the concept of invariant geometric relationships that are preserved in machine motions when the dimensions, materials and application of the machine or mechanism change. Recently it has been suggested that the kinematic geometry of mechanisms might have the same *a priori* status as the axioms of Euclidian geometry.

Although textual descriptions of machines can be found in the work of Roman engineers such as Pollio Vitruvius (c. 27 BC), extended catalogs of machines and kinematic devices began in the 15th century, such as those of Konrad Kyeser, Marianus Jacobus, also known as Taccola and Francesco di Georgio Martini as well as the posthumous Codices of Leonardo da Vinci (e.g. *Codex Madrid I*, 1493). These were followed by others such as Besson (1578), Ramelli (1588), in the 16th century and later by Leupold (1724) in the 18th century. The similarities in the machines depicted in these books are striking. However, these ‘theatre of machines’ books lacked a mathematical underpinning that began to emerge in the late 18th century (see Section II.9).

The formal codification of geometric machine constraints began in the work of the French thinkers at the Ecole Polytechnique in Paris under Gaspard Monge [1746–1818] in the late 18th century. Monge (1795) proposed that all engineering students be taught *descriptive geometry*. Descriptive geometry, sometimes called ‘projective geometry’ is the accurate representation of three-dimensional objects on a two-dimensional plane. Monge developed rules for rigorously projecting the geometric features of a solid onto two or more perpendicular planes. This became the foundation of what two centuries of students called ‘mechanical drawing’. The foundations of projective geometry can be seen in earlier theorems of Pascal and Desargues. Monge’s descriptive geometry was used at the US Military Academy in the early 19th century by Charles Davies (1859), who published his lecture notes. In his Preface, Davies stated that

In France, Descriptive Geometry is an important element in scientific education: it is taught in most of the public schools and is considered indispensable to the Architect and Engineer.

Davies noted however that descriptive geometry was not widely used in the United States at mid century.

Monge’s contemporary at Ecole Polytechnique, Jean N.P. Hachette in 1811 constructed a table of basic kinematic elements based on the transformation of motion; e.g. from circular to rectilinear or circular to alternating motions. This classification scheme for machine kinematic elements was very popular up until the work of Franz Reuleaux in 1875. A variation of Hachette’s table can be found in Figure I.20 from the work of the Italian

Borgnis (1818) describing the composition of machines. On the left hand column one can look up the type of input-output behavior one wants the mechanism to have; e.g. continuous rotary to intermittent motion, etc. The row to the right then shows a set of icons representing different possible mechanisms that will exhibit this characteristic motion. Such tables were very popular in the 19th century. This classification scheme for machine mechanisms using a tabular format predated the periodic chemical table of the Russian Dimitri Mendelayev in 1868.

Reuleaux's theory of kinematic motions in machines departed dramatically from these earlier schemes of mechanism classification based on the input-output motions. Instead he based his classification on geometry and topology of the connected kinematic elements in the mechanism. And while pictorial representation is beautifully represented in Reuleaux's books, his use of textual symbols was the beginning of a step away from a graphical language in machines to more abstract mathematical symbols and constructs such as differential equations and matrices.

Up until the late 18th century, the Aristotelian theory of so-called simple machines, the lever, screw, wheel, wedge, etc., held a dominant role in machine theory. Reuleaux is credited with the idea of a mechanism as a chain or network of geometrically constrained bodies. But the germ of this idea appears earlier in Willis in the preface to the second edition of his book:

For every machine will be found to consist of a train of pieces connected together in various ways, so that if one can be made to move they all receive a motion, the relation of which to that of the first is governed by the nature of the connection.

Willis's plan was "*to reduce the various combinations of pure mechanism to system, and to investigate them according to geometric principles alone*".

Before the late 18th century, machines were often classified according to application; pumps, machine tools, military machines etc. Monge and his contemporaries instead grouped machines according to how they changed motion, from say circular to rectilinear or from rectilinear to alternating motion. Willis criticized this classification, as did Reuleaux some years later. He pointed out that the conversion of circular to rectilinear motion as a method of classification *lacked uniqueness*, thus it could not capture the essence of the mechanism. For example in the four-bar linkage shown in Figure I.24, the continuous motion of the crank on the left creates a rocking motion of the right-hand link, sometimes called a *crank-rocker* mechanism. But if one grounds the crank link, circular motion of the new crank determines circular motion of the new follower link. This new mechanism, using the same

kinematic chain, is called a *drag-link* mechanism. Thus several input-output motions can be obtained from one kinematic chain of links and joints, depending on the relative lengths of the links and which link is grounded. This was the basis of Willis and Reuleaux's arguments on the non-uniqueness of the French tabular classification of mechanisms based on input-output motion characteristics.

Franz Reuleaux's major work in kinematics was first published as a series of articles by the Prussian Society for the Advancement of Industry in 1871–1874 and published as a book in 1875 under the title, *Theoretische Kinematik: Grundzüge eine Theorie des Maschinenwesens*. It was translated almost immediately into French, Italian and English, the latter by Professor Alexander B.W. Kennedy of University College London in 1876 under the title, *The Kinematics of Machinery: Outlines of a Theory of Machines*. The ideas that Reuleaux presented in this book influenced the field of machine design for a century. Reuleaux published a sequel to this work in 1900, called, *Lehrbuch der Kinematik; Zweiter Band. Die Praktischen Beziehungen Kinematik zu Geometrie und Mechanik* (roughly, Textbook in Kinematics, 2nd Volume. The Practical Relationship between Kinematics and Geometry and Mechanics). However, by the new millennium the science and design of machines had moved away from kinematics into new areas of thermodynamics, materials and electrical machines and Reuleaux's last work did not have the impact of his earlier work. In 1893, Reuleaux published the fourth edition of his widely used *The Constructor*, in English for the first time. (The use of the French term 'Constructor' which can be translated as 'designer' was unfortunate, as in the US it is associated with civil engineering not mechanical engineering.) However, in this edition, which was translated by Henry Suplee, an early figure in the American Society of Mechanical Engineering, Reuleaux presented a summary of his kinematic theory of machines along with his detailed descriptions, technical data and formulas for the design of machine elements.

As described earlier, Reuleaux's key idea in his kinematics is that all mechanisms with rigid bodies can be studied by looking at the relative motion of pairs of elements or joints. Reuleaux went beyond Willis in stating that, all determinate mechanisms are formed by a kinematic chain of joint pairs, recognizing the important fact that the grounded elements are often part of the chain of kinematic links (Figure I.24). He implicitly introduced, perhaps for the first time in engineering, topological ideas into kinematics. By changing the ratio of link lengths and diameters of cylindrical joints, he was able to generate a large class of mechanisms all of which have the same

sequence in the chain of geometric constraints between pairs. For example, he was able to show that a dozen or more of rotary motors and pumps were all members of the same kinematic family, even though many had different inventors. Reuleaux believed that this methodology would provide a tool for kinematic synthesis or what is called today, *topological synthesis*.

REULEAUX'S TOPOLOGICAL THEORY OF KINEMATIC MECHANISMS

Topology is defined as that branch of mathematics that deals with the most general properties of mathematical objects such as geometric figures. In the 19th century, topology was known by the Latin *geometrica situs or analysis situs*. The term *topology* originated from a book title of the German mathematician Johann B. Listing (1848) of Göttingen. However the subject did not mature until the 20th century beginning with the work of H. Poincaré. One of the earliest theorems in topology is due to L. Euler (1736). This theorem is described in terms of polygonal nets or circuit networks made up of e nodes, k links and f faces. Euler's rule states that; $e - k + f = 1$; i.e., the number of nodes, geometric faces or polygons enclosed by k lines or links is related for any planar net where every link is connected to two nodes.

Kirchhoff also used similar general relations in positing his theory of electric circuits in 1847. In the case of a network of mechanical linkages connected to form a movable mechanism, similar topological relationships can be found. With so many of the pioneers in topology from late 19th century Germany and Europe, it is not surprising that topological thinking appeared in the work of Franz Reuleaux's theory of kinematic machines especially the idea of a kinematic chain or network.

The most familiar paradigms in the topology of geometric objects are the Möbius band, knot theory, tiling of surfaces, networks, the Klein bottle and the famous topological equivalence of the coffee cup and the donut or torus; i.e. each has one essential hole. This latter idea in the topology of geometric objects is the notion that two objects are topologically equivalent if one can transform one into the other, without tearing or ripping. Thus the term '*rubber sheet topology*'.

In order for two objects to belong to the same topological class they must share some common general relationship, as in Euler's network problem. The objects must be shown to be equivalent under a proper set of transformations or group. It is this idea of topology that Reuleaux used in his theory of mechanisms. Starting with the concept of a kinematic chain as a sequence of kinematic constraints or joints between neighboring links, he expanded or contracted some of the dimensions of the links and joints to generate a class

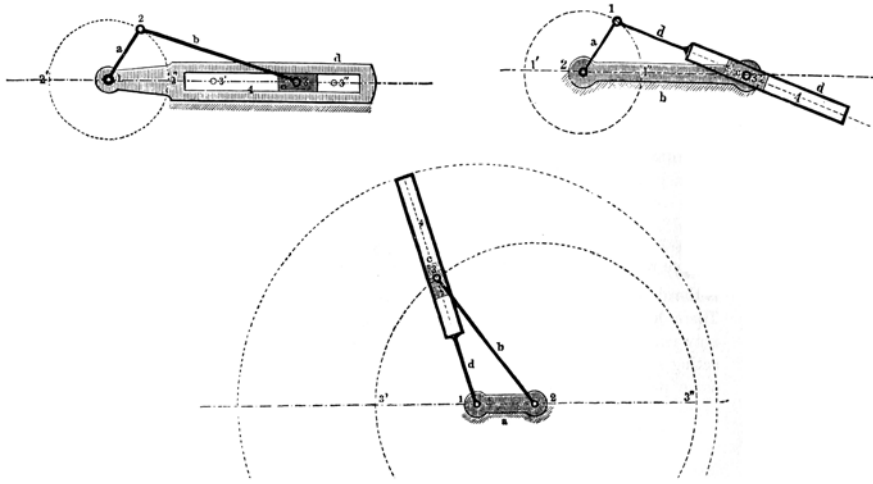

Figure I.27a. Inversions of the slider-crank mechanism (Reuleaux, 1876a)

of mechanisms that have a common sequence of joints and links. Aside from an interesting mathematical exercise, Reuleaux claimed that this searching the space of mechanisms within his defined kinematic group was an essential tool for kinematic synthesis and invention. Reuleaux enumerated six ways to generate a class of mechanisms with the same kinematic joint sequence in the chain;

Inversions: changing the grounded element in the chain of kinematic pairs.

Reuleaux recognized that in a kinematic circuit with four degrees of freedom of motion, any one of the links could be grounded, eliminating three degrees of freedom, to form a single degree of freedom mechanism. Thus a four-link slider crank chain could become four mechanisms (Figure I.27a).

Expansion of elements: enlarging or changing the scale of different links in the chain.

This idea is closest to the modern concept of topological transformations or ‘rubber sheet’ topology. Reuleaux was able to show that the slider-crank mechanism, used today in millions of vehicle engines, was kinematically equivalent to the eccentric mechanism shown in Figure I.27b, in which he stretched the cylindrical bearing to where it was larger than the length of the crank.

From plane to conic chains: redefining a planar linkage to one on a sphere.

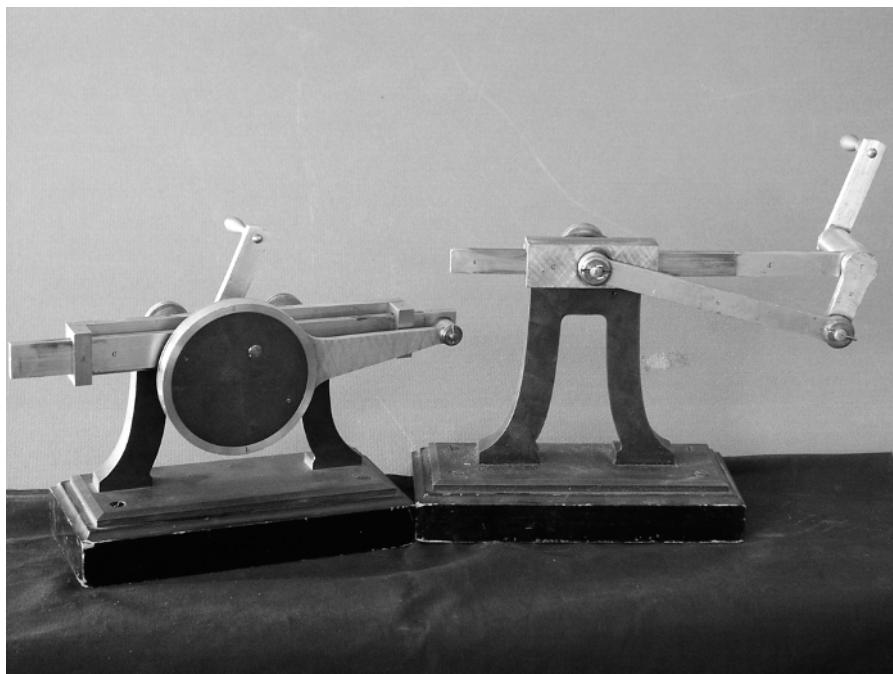

Figure I.27b. Expansion of elements of the slider-crank mechanism (right) into an eccentric mechanism (left). (Models from the Cornell Kinematic Mechanisms Collection: See models C-2, E-2, on the KMODDL website)

In this extension of a class of mechanisms, Reuleaux took a linkage in a plane surface and mapped it onto a spherical surface. For example he showed that the universal or Hooke's joint was identical to the motion of a four-link chain on a sphere. He also used topological thinking to relate the universal joint to a spherical engine, also mapping the parts onto a set of links on a sphere.

Reduction of kinematic chain elements: reducing the length scale of one link to zero while maintaining the geometric constraint.

An example of this method is in the case of the slider crank in which the length of the slider is reduced to zero and the cylindrical joint moves in the slide. Here Reuleaux essentially substitutes a lower kinematic pair, i.e. two flat sliding surfaces, with a higher kinematic pair in which the sliding cylinder has only line contact with the linear guide.

Augmentation of kinematic chains: serial linking of kinematic chains.

In this method, several basic kinematic chains are coupled together. (This would not be a topological operation.)

Generation of compound chains: the use of more than one circuit of kinematic chains. (This would not be a topological operation.)

In this method, adding extra links and joints as in a six-bar chain of links can extend a one degree of freedom kinematic chain using four links. An example is shown in Figure I.30.

REULEAUX'S SYMBOL NOTATION

Reuleaux's attempt to place machines in the context of geometry and topological invariants led him to propose a symbolic language to codify these invariants. The key to his classification was the recognition that every mechanism could be represented as a chain of kinematic pairs or constraints. Each constraint involved a geometric relation between adjacent parts. A piston in a steam engine, for example, is confined to slide back and forth in the cylinder. Each link on a bicycle chain is constrained to rotate about an axis relative to the adjacent link and so on. Each constraint he represented as a symbol, letters with superscripts and subscripts.

In chemistry and biology attempts were made to classify the objects of these sciences with tables and abstract notation. The periodic table of elements in chemistry by the Mendeleev and Myer appeared in the middle of the 19th century. Similar attempts at classification of machines were also attempted. For example Jean N.P. Hachette, in 1811, constructed a table of mechanisms according to how these mechanisms change motion from say circular to linear motion or from circular to intermittent motion. Charles Babbage (1826) of computer fame, created a mechanical notation using lines and arrows to show how one part of a machine drives another. Unlike Hachette, Babbage's notation tried to show relationships between different parts of the machine. However, the notation required a two-dimensional tabular array for each device not unlike that in a music score. He presented an example of an hour counting mechanism for a clock that encompassed two full pages. There was a similar effort by Cambridge professor Robert Willis (1841) who devoted the entire Chapter X of his book to '*mechanical notation*'. His method is similar to Babbage's in that the machine is represented by a table with entries for names of the parts, the numbers of gear teeth, angular velocities, and the type of motion, i.e., steady, oscillatory, or intermittent.

In his quest for an alphabet of machine devices, Reuleaux built the world's largest collection of machine components, a dictionary of sorts of over 800 models. Using his symbolic system, along with his models, Reuleaux sought to deconstruct every machine that had been or would be invented in the future, a Genome project for the Machine Age.

A century earlier, in 1735, the Swedish biologist Carolus Linnaeus had constructed a taxonomy for plants and animals using ideas of species, genus, family, orders, etc. Some of these biological taxonomies were based on physical similarities and some on evolutionary ancestors. Initially, Reuleaux tried to classify machines based on function, such as *guiding*, *storing*, *driving*, and *forming* or *place-changing* machines versus *form-changing* machines. He was perhaps influenced by Borgnis (1818) in his *Traite complet de mécanique* who divided machines into six categories; *récepteurs*, *communi- cateurs*, *modificateurs*, *supports*, *régulateurs*, and *opérateurs*. Reuleaux however abandoned the function-based approach, in favor of a syntax-based methodology using a model based on linguistics rather than biology, a model patterned after chemistry. Each machine is comprised of a chain or network of constrained links and the key to distinguishing one machine from another was the sequence of these different link joint pairs. Each kinematic pair could be written as a symbol and the entire machine as a sequence of symbols. A factory is then a sequence of symbolic words or a sentence representing a complex assembly of machines.

Reuleaux introduced his symbol notation in Chapter VII of *Kinematics of Machinery* (1876). His notation essentially maps kinematic constraint pairs onto a set of symbols. For example, Reuleaux used the symbol ‘C’ to represent a cylindrically coupled or revolute kinematic pair. He used the symbol ‘P’ to represent a prismatic kinematic pair, ‘S’ to represent a screw pair.

Reuleaux’s symbol notation has three different kinds of symbols:

Class or name symbols; [S screw, P prism, C cylinder, K cone, V vessel, etc.]

Form symbols; [+ full body, – open body, z teeth (Zahn), λ liquid, γ gas]

Symbols of relation; [... linkage, ____ grounded link, || parallel axes, | co-axial, + crossed at right angles, < non-right angle]

Examples of a kinematic circuit with symbols are shown in Figure I.29. The ‘compressed’ circuit notation is illustrated in the table in Figure I.28. Examples of his compressed notation include:

$(C_4^{\parallel})^d$;	Four-bar linkage (link ‘d’ grounded)
$(C_3^{\parallel} P^T)^d$;	Slider-crank (link ‘d’ grounded)
$(C_3^T C^<)^{a/b}$;	Universal joint
$S' P' C'$	Screw actuated prismatic slide

7. Isosceles double-crank	$(C_2'' \leq C_2'')^{d=a}$	
8. Isosceles double-lever	$C_2'' \leq (C_2'')^{h=c}$	
B. Slider-Crank Chain $(C_3'' P^\perp)$.		
9. (Turning) slider-crank	$(C_3'' P^\perp)^d$	
10. Swinging block (slider-crank)	$(C_3'' P^\perp)^b$	
11. Turning block (slider-crank)	$(C_3'' P^\perp)^a$	

CHAMBER-CRANK TRAINS.

PLATE XXI.

Turning Block $(C_3'' P^\perp)^a$.

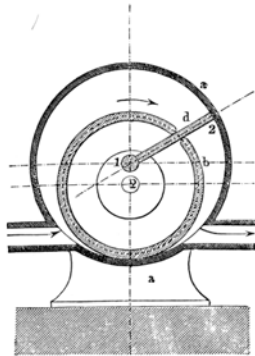

FIG. 1.—Cochrane. (Eng.)
 $(C_3'' P^\perp)^a - c$; $(V^\pm) = d, a$.

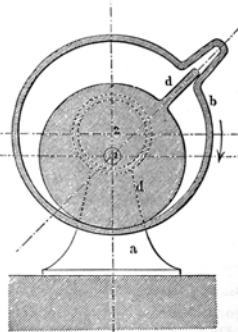

FIG. 2.—Cochrane. (Pp.)
 $(C_3'' P^\perp)^a - c$; $(V^\pm) = d, b$.

Figure I.28. Sample symbol table for mechanisms from Reuleaux's *Kinematics of Machinery* (1876), for slider linkages and rotary pump-engine mechanisms

For a steam engine Reuleaux used the symbol:

$$(C_3^{\parallel} P^T)^{d/c}; (V^\pm) = c, d; \quad \text{Steam or gas engine}$$

The first symbol for a four-bar mechanism indicates four cylindrical or revolute (rotary) joints, all axes parallel as notated with the superscript on the letter C. The four links are labeled a, b, c, d. The superscript 'd' indicates that the d-link is grounded (see Figures I.28 and I.29).

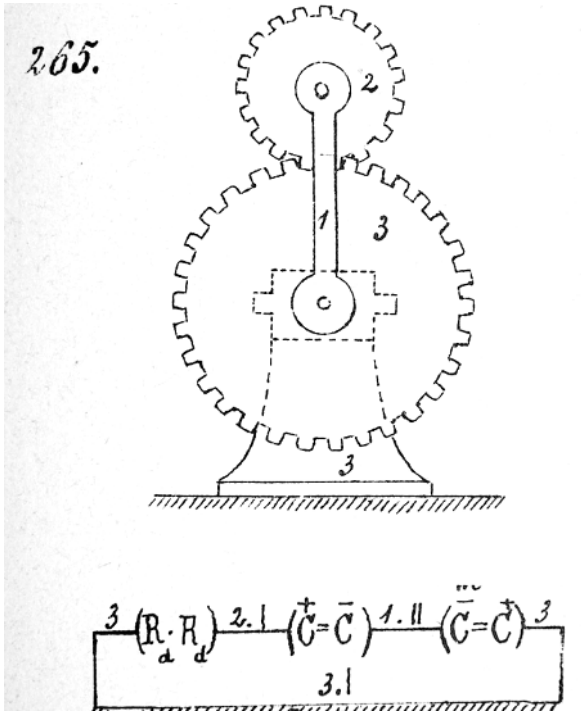
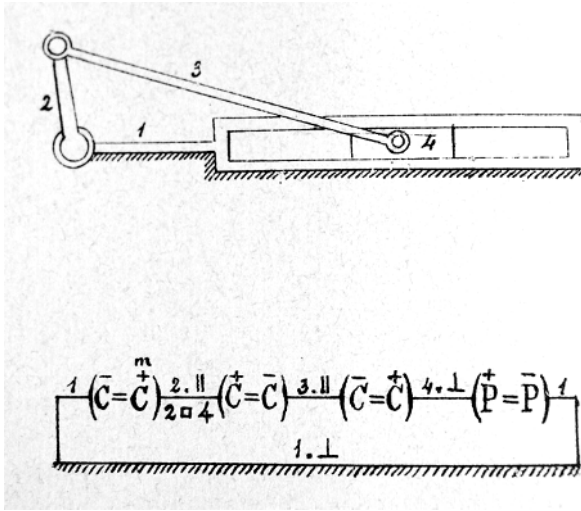

Figure I.29. Kinematic circuits and symbols based on Reuleaux, published by Francesco Masi (1883)

The second symbol above for the slider-crank mechanism is the compressed notation for three revolute joints with parallel axes and a prismatic joint, i.e. linear sliding, where the direction of sliding motion is transverse to the rotary axes. (Reuleaux used an inverted Tee without serifs to indicate a perpendicular axis.) His notation does not include any information of mass or moment of inertia. In this sense it is pure geometry and topology based. For example, a flywheel cannot be represented as a carrier of kinetic energy, since his notation is not based on dynamics, forces, or energy.

The Italian machine theorist Francesco Masi (1883, 1897) published an extensive set of kinematic symbols for dozens of mechanisms in his 1883 book. Two of these are shown in Figure I.29.

Another example of a generating class of mechanisms is the universal joint (Cardano and Hooke) that can be shown to have the same symbol as a spherical mechanism for a rotary steam engine patented in 1836 by Taylor and Davies. The kinematic chain symbol for both is $(C_3^T C^<)^{a/b}$. Here the second superscript $<$ represents an axis at an angle to the other revolute axes. The superscript 'a' indicates the name of the fixed link and the symbol 'b' the name of the driven link.

Reuleaux's use of inversions and expansion of elements implicitly uses another set of data for the mechanism, namely the relative sizes of the links and constraint elements such as diameters of cylindrical bearings and size of the slider. For example, in the case of the slider crank, he labels each link $\{a, b, c, d\}$ where the slider is 'c'; and he labels each of the three cylindrical joints with $\{1, 2, 3\}$ where link 'a', is between joints '1' and '2'. These symbols were engraved on the links of many of his kinematic models. (See the KMODDL website of Cornell Reuleaux models to view the engravings on the links and joints.)

An important concept in Reuleaux's theory is his use of *inequality relations for machine synthesis* or the idea of relative sizes of the bearing and link geometries. Although this is not explicit in his text, it is clear from his writing that changing dimensionless, geometric groups can generate a family of mechanisms with the same constraint symbol. For example we could think of the symbol for the slider crank as incorporating dimensional variables (as in the modern sense of object oriented programming); i.e., $C_3^{\parallel} P^T \{L_a, L_b, L_c, L_d, d_1, d_2, d_3, w\}$, where the 'L's are the lengths of the links (L_c is the length of the slider) and the 'd's are the diameters of the cylindrical joints. The width of the slider is 'w'. Reuleaux is then able to generate a family of slider crank mechanisms by changing the relative lengths as

represented by inequalities. For example, the classic slider crank involves the inequalities;

$$d_1 < L_1, \quad d_1 < L_4, \quad \text{etc.}$$

i.e., the diameters of the cylindrical joints are less than the lengths of their neighboring links. However, Reuleaux then asked the reader to imagine the mechanism with $d_1 > L_1$ or $d_2 > L_1 + L_2$, and proceeded to illustrate these ‘new’ mechanisms, which all have the same symbol word, but have different inequality relations between the link and cylinder pair dimensions. Some of these mechanisms he reminded the reader had been invented earlier. In making these expansions, Reuleaux attempted to ‘exhaust’ the topological possibilities of the basic slider crank kinematic chain to show ‘*the possibility of the machine*’. Two members of this family are shown in Figure I.27b in which Reuleaux showed how the crank was related to the eccentric mechanism. Using his topology based methodology he was able to derive 54 mechanisms from the four-bar linkage and classify them into 12 classes.

Although Reuleaux’s ideas about kinematic pairs and open and closed chains in mechanisms have survived in texts today, his symbol notation all but died with his passing (see Hartenberg and Denavit, 1964). However, in the modern field of computational multi-body dynamics, graph theory symbol notation is used to represent the connection properties between bodies in a complex machine.

GRÜBLER’S THEOREM; MOBILITY OF MECHANISMS

In analogy to electrical circuits, the closed mechanical circuit can be generalized into multiple circuits or kinematic network, called compound linkages, shown in Figure I.30.

James Watt used compound mechanisms in the design of his steam engines, as well as by George Stephenson in his steam locomotive engines. One of the properties of compound linkages is the existence of topological invariants. Topological relationships describe general properties of geometric objects independent of their specific dimensions and shapes. For example, if ‘n’ denotes the number of links in a planar kinematic network, ‘r’ the number of revolute or cylindrical joints, and ‘F’ the number of degrees of freedom in the mechanism, sometimes called the *mobility*, then the following relationship can be established:

$$2r - 3n + (3 + F) = 0 \tag{1}$$

or

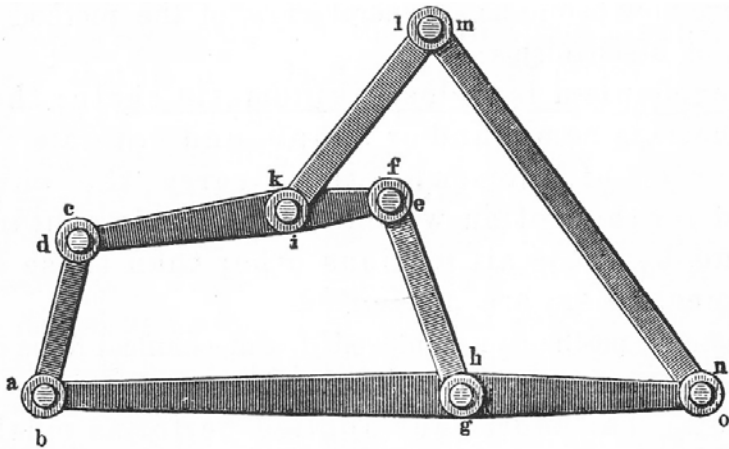

FIG. 12.

Figure I.30. Six-bar compound mechanism with one degree of freedom (Reuleaux, 1876a)

$$F = 3(n - 1) - 2r. \tag{2}$$

For one degree of freedom or, $F = 1$,

$$r = \frac{3}{2}n - 2. \tag{3}$$

The conventional derivation of equation (2) begins with a set of n links in the plane with $3n$ degrees of freedom (two translations and one rotation) with one grounded link leaving $3(n - 1)$ degrees of freedom. A set of r lower pair joints such as turning pairs or revolute joints removes $2r$ degrees of freedom hence the expression above. The interpretation of F is that $F = 1$ indicates a perfect mechanism where the movement of one link determines the movement of all the rest of the links. If $F = 0$, the arrangement of links forms a statically determinate rigid truss or structure and if $F = -1$, the structure is statically indeterminate and the internal forces are dependent on the elastic properties of the links.

Relations (2), (3) for $F = 1$ were posited by Martin Grübler in an 1883 paper in *Der Civilingenieur* and later in his 1917 book on kinematics, *Getriebelehre* (Berlin). Grübler [1851–1935] was a professor at the Technische Hochschule Dresden and was influenced by the work of Franz Reuleaux. These relations hold for planar mechanisms. Similar equations can be written for spatial linkages. Grübler credited two mathematicians for this criterion, Sylvester and the Russian Chebyshev.

A modern discussion of the use and limitations of mobility criteria may be found in the English texts of Burton Paul (1979), D.C. Tao (1967), Joseph

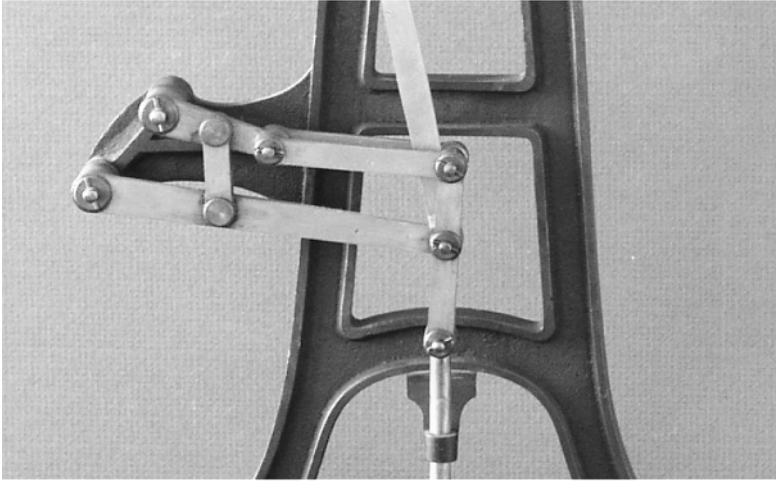

Figure I.31. Reuleaux straight-line mechanism with six links and seven joints. ($F = +1$) Model S-32 in the Voigt catalog. (Cornell Kinematics Model Collection)

Shigley (1963), Richard Hartenberg and Jacques Denavit (1964) and Arthur Erdman and George Sandor (1997).

In relation (2), r , n , F are integers and the number of degrees of freedom assumes that one link of the network is grounded. The minimum number of links for $F = 1$, is $n = 4$, which gives $r = 4$. The integer requirement implies that the number of links n must be even, which leads to the sequence of possible single degree of freedom compound mechanisms:

$$\{(n, r) = (4, 4), (6, 7), (8, 10), (10, 13) \dots\}.$$

An example of a six-bar linkage with seven pin joints and one degree of freedom is the approximate straight-line mechanism of Reuleaux Model S-32, from the Voigt catalog of Reuleaux's models (Figure I.31).

In Figure I.31 we can see seven joints, ignoring the upper crank arm and the lower slider arm that are not essential to the mechanism. In this mechanism there are two links with three joints, one of the upper horizontal links and the lower horizontal link. One link is grounded, namely the pedestal, and the right most link traces an approximate straight-line motion as indicated by the gratuitous slider joint below the right link.

The linkage in Figure I.30 is a generalization of the closed four-bar linkage to include rigid links with more than two revolute joints. Thus if n_i denotes the number of links with i joints, then the equations relating the number of sub links to the total number of links and joints are (Grübler, 1917):

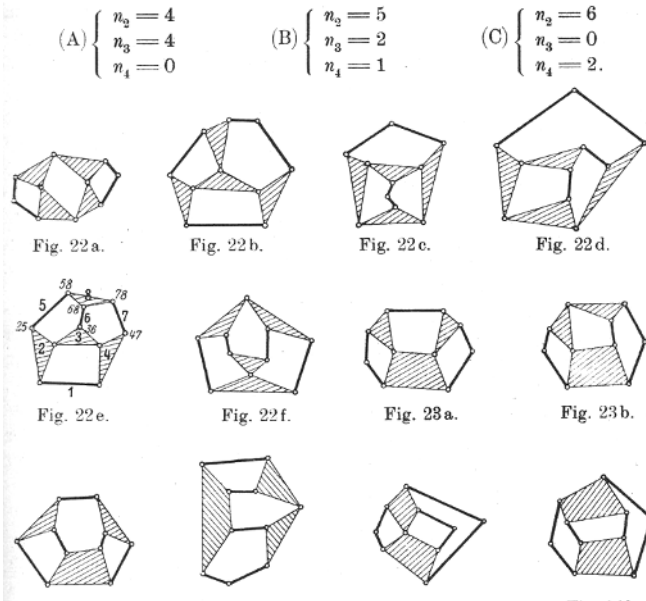

Figure I.32. Table of eight-bar linkages with one degree of freedom when one bar is grounded (Grübler, 1917)

$$n = \sum_{i=2} n_i, \tag{4}$$

$$r = \frac{1}{2} \sum_{i=2} i n_i; \quad (F = 1). \tag{5}$$

For example, in the case of the six-bar mechanism in Model S-32, we have $\{n = 6, n_2 = 4, n_3 = 2\}$, with $r = 7, F = 1$.

In the case of eight-link mechanisms, one can also have four-joint links. It is easy to show using the above equations that there are three classes of eight-link mechanisms:

$$\{n_2 = 4, n_3 = 4, n_4 = 0\},$$

$$\{n_2 = 5, n_3 = 2, n_4 = 1\},$$

$$\{n_2 = 6, n_3 = 0, n_4 = 2\}.$$

Within a single class of eight-link mechanisms there can be multiple distinct topologies as shown in Figure I.32 from Grübler (1917: Figures 22, 23).

In typical sketches of compound linkages, two-joint links are drawn as straight lines, three-joint links as triangles, and four-joint links as trapezoids.

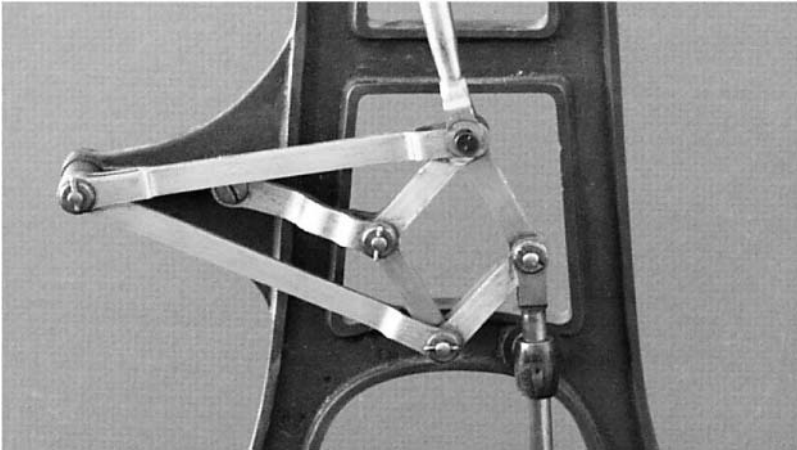

Figure I.33. Peaucellier exact straight-line mechanism with eight links and ten revolute joints: one degree of freedom with one link grounded. (Reuleaux–Voigt Model S-35, Cornell Kinematic Mechanisms Collection; See also KMODDL website)

The revolute joints are drawn as open circles. In actual compound mechanisms however, the links can have any shape.

An example of a compound mechanism is the straight-line mechanism of Peaucellier shown in Figure I.33 of Reuleaux–Voigt Model S-35.

This was the first recognized *exact*, planar, straight-line mechanism, traced by the right most pin joint. This mechanism has $n = 8$ links, and $r = 10$ turning joints (counting the four double pin joints and ignoring the upper crank arm and the lower slider arm which are not needed in the pure Peaucellier cell). For this arrangement, $F = 1$. The outer pin can trace either an exact straight line or an exact arc of a circle of any radius.

Finally we may apply Grübler’s mobility criterion to one of Leonardo da Vinci’s mechanisms from the *Codex Atlanticus*, called a lazy tongs or what one reference called ‘Nürnberg shears’ shown in Figure I.34. The vertical motion of the pin on the sliding block moves the rhombus shaped linkage. This linkage appears in two different folios. The incomplete linkage (CA Folio 16r) contains six links and seven rotary joints, double counting the two joints at the top and bottom that each connect three links. Using Grübler’s equation (2) we obtain a degree of freedom, $F = 1$, as expected.

Grübler’s generalization of the possibilities of compound kinematic mechanisms did not appear in Reuleaux’s work. Reuleaux can be credited with using topological ideas in kinematics to encompass a large class of mechanisms within a given sequence of joint constraints in a kinematic chain. Mathematically Reuleaux was likely influenced by the geometric kinematics of Euler

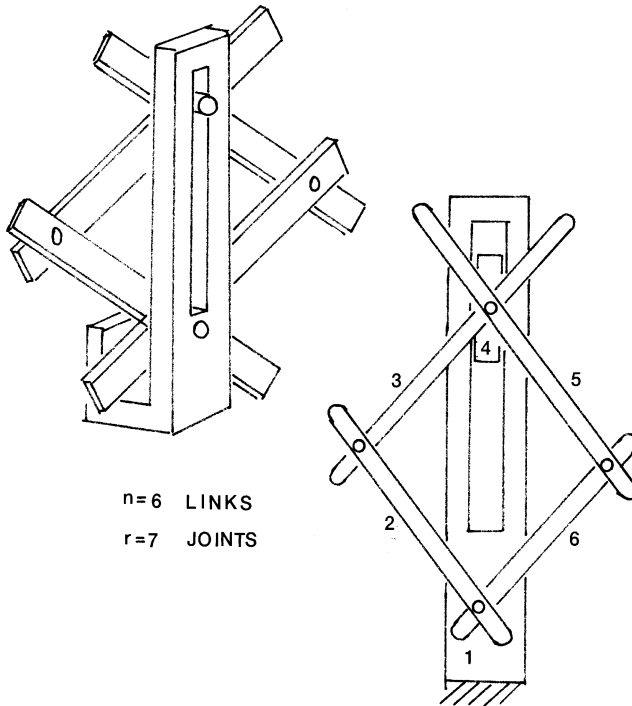

Figure I.34. Sketch of Leonardo's 'lazy tongs' or 'Nürnberg shears' mechanism of Leonardo da Vinci; six links and seven revolute joints

in 1765, Poinsot (1834) and Aronhold (1872) in kinematics of rigid bodies as he mentioned in his *Kinematics of Machinery* (1876). Reuleaux was also preoccupied with a search for a method of machine classification as again illustrated in the opening chapter of his book. He rejected the schemes of Monge, Willis, Belanger, Haton and other French writers in the mid 19th century based on motion changing principles. He instead settled on the more abstract method of networks of geometric constraints that later inspired other theoreticians in mechanism theory.

The concept of the kinematic chain idea brought mechanism theory into analogy with electrical circuit theory. Reuleaux, with few exceptions, did not treat mechanisms with more than one circuit or one degree of freedom, where one link is active and the others are follower links. However, there are differential mechanisms, used in automobile transmissions, which have two input links. Nor did Reuleaux develop an energy theorem for his kinematic circuit analogous to Kirchhoff's circuit law. The extension of the kinematic chain to multi-circuit mechanisms, which Reuleaux called 'compound chains', was

developed later in the 20th century in the form of network theory, graph theory, and screw theory (see e.g. Davies, 1983; Phillips, 1990).

The Reuleaux 'School' of kinematics that included Kennedy (1886) in England and Burmester (1888), Hartmann (1913) and Grübler (1917) in Germany, and Masi (1883) in Italy, influenced the ideas, constructs and nomenclature of kinematics to this day.

I.9 SUMMARY

In reviewing the career of Leonardo da Vinci we have tried to place his work in the context of other Renaissance artist-architect-engineers. Though not unique as an illustrator and inventor of machines, his machine drawings began a four-century evolution in machine theory in conceptualizing the machine as a set of basic machine elements and kinematic mechanisms that matured into the theories of Robert Willis and Franz Reuleaux. Both Leonardo and Reuleaux were intrigued by the nature of invention of technology. This theme will be further developed in Part II of this book.

In the Machine Age of the early 19th century, the manufacture of machines was a workshop process passed on to apprentices by master mechanics and engineers who often kept their methods secret and guarded against use by their competitors. The steam engine however, sparked not only a revolution in the creation of a mobile energy source, but also in the methods of creating new machines. The wresting of machine design from the workshop began in the Ecole Polytechnique in Paris in the late 18th century with the work of Monge and Hachette, and later by Ampere and Lanz and Betancourt. These ideas were further developed in Britain, especially in the work of Robert Willis [1800–1875] and William Rankine [1820–1872] and in Germany by Ferdinand Redtenbacher [1809–1863] of the Polytechnic School at Karlsruhe whose student was Franz Reuleaux. Reuleaux created a more abstract language for describing machines. He was also the first engineer to use topological ideas in kinematics as a method to enumerate the set of possibilities for the invention of new machines.

In this review of the life and work of Leonardo da Vinci and Franz Reuleaux we have encountered many other engineers and machine designers who were part of this evolution of our knowledge of machines today. In Part II we present a review of the wider history of machine evolution and the role that mathematics, mechanics and art played in this history. We will also try to evaluate the roles and contributions of Leonardo and Reuleaux in the design of machines during this period.

PART II

Evolution of Design of Machines

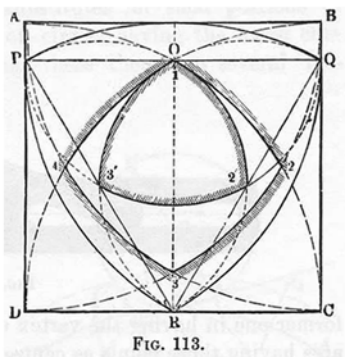
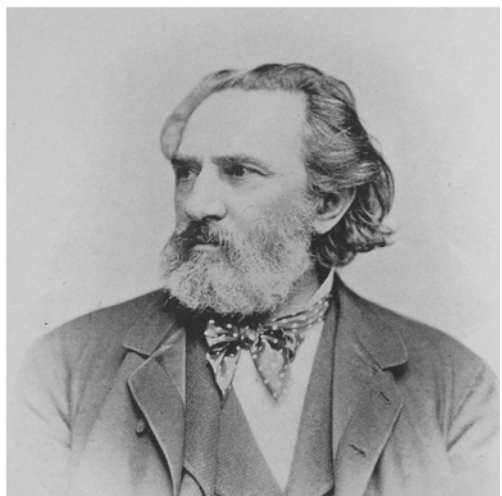

FIG. 113.



Leonardo da Vinci:

“Aristotle and Alexander were masters of each other. Alexander was rich in great power, which gave him the opportunity to seize the world. Aristotle had great knowledge, which give him the opportunity to seize the totality of the sciences elaborated by all the other philosophers.”

[*Codex Madrid II*, Folio 24 recto; transl. L. Reti.]

Franz Reuleaux:

“Every people that appears in history shows itself more or less familiar with machines, of however imperfect a kind. We do not find the actual beginnings with them, their traditions only give us information as to the progress and improvement. We must enter the domain of ethnology, the study of primitive peoples–. For inquiry points more and more distinctly to the conclusion that the human race as a whole has everywhere grown through similar stages, processing according to great natural laws.”

[*Kinematics of Machinery*, p. 203; transl. A.B.W. Kennedy.]

II

Evolution of Design of Machines

II.1 INTRODUCTION

SOCIETAL CONDITIONS FOR INVENTION

What is necessary for a culture to produce new machines and technology? A recent book claimed one should study the thinking of Leonardo da Vinci to find the seven principles of genius and creativity. The premise of this and similar self-help books is that the secret of creativity is in the individual. Yet historical evidence convincingly shows that a set of societal conditions must be met to create and produce a new technology and that such conditions existed in Leonardo's time. Some of these conditions include the following:

- (i) The society must have a tradition of building machines;
- (ii) there must exist a cadre of artisans and craftspeople with technical skills;
- (iii) there must exist a supply of capital to invest in new technology;
- (iv) there must exist in the society a spirit of progress, that humankind is meant to improve and change its environment;
- (v) finally there must exist individuals with a vision and motivation to change the status quo.

In the following sections we illustrate these preconditions for genius to flourish in designing new machines. First we review the roots and traditions of Western science and technology in antiquity. In the Middle Ages, the growth of cities and guilds began to nurture skilled craftspeople. During this so-called Dark Ages, the Scholastics in the Church schools developed ideas of reason and progress as part of God's plan for humanity. Out of the merchant class there arose trade and the exchange of goods that generated both capital and a need to enhance production of goods.

During the Middle Ages, there also emerged a group of men who had the vision, genius if one can call it, to imagine fantastic cathedrals and castles and machines beyond the experience of the average person. This machine tradition, skill set, capital and vision that emerged in Western Europe blossomed in 15th century Renaissance, and evolved over four centuries into the Industrial Age of the 19th century. In the last two centuries, this process of technology-creation has spread from Europe to North America, to Asia and the rest of the world to engulf our 21st century global culture. The following sections are written in the hope that the reader will be convinced that if it takes a village to raise a child, it takes a civilization to create a machine.

MACHINES IN ANCIENT TIMES

In 1900, a Greek sponge fisherman discovered the remains of ancient ship cargo on the bottom of the sea off the coast of the island of Antikythera. Initially there was interest among archeologists in the pottery, jewelry and furniture that was dated around 80 BCE. Also in the wreckage on the ocean floor was a curious wood and brass object that soon changed the view of Greek expertise in machine technology. The greenish mass of metal, when cleaned up, turned out to be an extremely complicated clock-like mechanism. X-ray tomography in later decades revealed that this 'green box' contained thirty meshed gears affixed to a brass plate. In a 1959 article in *Scientific American*, Professor Derek J. de Solla Price of Yale University published a detailed description of this remarkable device and claimed that the kinematic mechanism was used as an astronomical calendar. On the brass plate were several areas with ancient inscriptions consistent with the motion of the planets.

Recently a replica of this mechanism was built by a curator in the British Museum, Michael Wright, who believes that similar devices can be found in the Middle Ages in the Arab world before the Renaissance period of Leonardo. This so-called Antikythera mechanism provides evidence for three observations. First the Greeks and possibly the Babylonians had a working knowledge of astronomical motions of the planets. Second they had the mathematical skills to translate that knowledge into a mechanical calculator. And finally the Greeks had the technical skills to construct a complex working gear mechanism that would translate mathematics into motion of dials on the brass plate.

Historians have identified three major eras of machine invention and development; the golden age of ancient Greece 300–100 BCE, the Renaissance of the 15th and 16th centuries and the so-called Industrial Revolution of the late 18th century to early 20th century. Although our focus in this book is

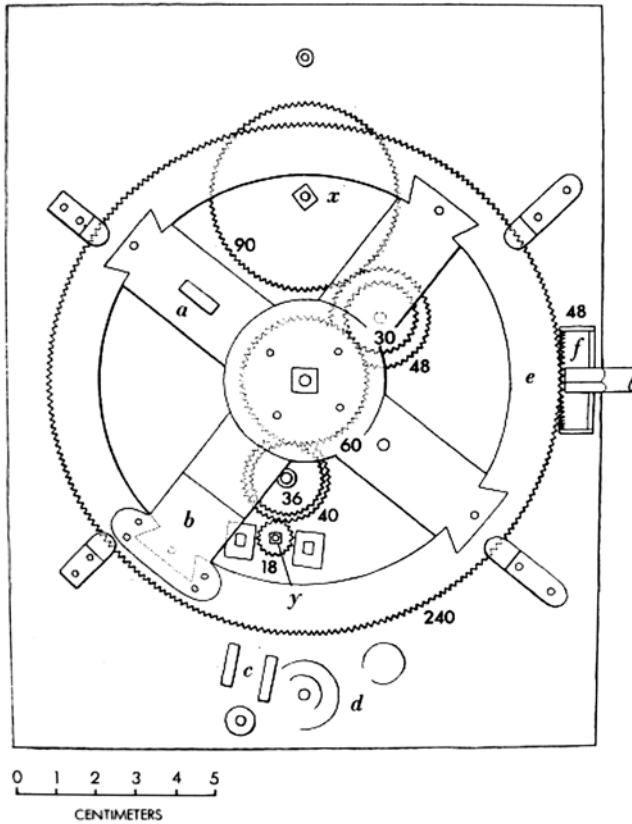

Figure II.1. Partial reconstruction of Greek Antikythera Mechanism by D. de Solla Price. This multiple gear device is believed to have been used to calculate the motions of the planets. (Scientific American, 1959, with permission)

to compare machine engineering of the latter two eras, it is useful to examine what was inherited from the earlier Greek and Roman eras as well as the Arab ascendancy that followed. In traditional texts the names of Aristotle, Archimedes, Hero, Vitruvius, and Pappus are often described as both chroniclers and inventors of machines of the ancient era. But before we embark on the litany of great machine engineers of ancient times we might reflect on the wider question of whether machine intelligence was the product of genius inventors or whether there was a natural evolution of mechanisms akin to the development of tools and language.

II.2 VISUAL KINEMATIC PERCEPTION OF MECHANISMS

In exploring the nature of machine invention, one must struggle with the juxtaposition of the evolutionary theory of technology and the popular theory of the ingenious inventor. The wide-ranging studies of Leonardo da Vinci in his writings and drawings of science and technology are most compelling for us humans. We want to cheer him on, in his struggle with ignorance and indifference. We have dozens of heroes like him: James Watt, Samuel Morse, Nicolas Otto, Thomas Edison, Marie Curie, the Wright Brothers etc. On the other hand, there is much evidence that almost all major machine objects have evolved over centuries and millennia. In a review of ancient machines, there is the same conflict; names such as Archimedes and Hero are assigned as inventors to machines that may have had earlier origins. But suppose there is another theory in the mix, that somehow humans may be hard-wired in the brain to invent machines.

As a prelude to a review of ancient machines, we speculate on the thesis that mankind's skills at creating machine artifacts are as much related to human evolution as is language, speech and use of tools. Visual recognition of complex human and robotic motions is an active area of cognitive science research today. So-called artificial intelligence algorithms are now a part of many robotic systems. Robotic computer vision systems need to identify moving objects and separate them from other moving objects. If the human brain can design robotic computer vision systems that can recognize objects under different orientations, distances and lighting, then why wouldn't visual *kinematic perception* be innate to humans themselves?

If the idea of machine creation by humans is critically tied to the evolution of motion recognition in the brain, then we might speculate on the possibility that the concept of '*mechanism*', as a set of linked moving objects, might be hard-wired into humans through a more primal thread of evolution in the brain. The ability of the brain to connect the complex motions of linked objects, be it another animal or an inanimate mechanism, might be called the concept of *kinematic mapping*, i.e. the ability of the human brain to map the infinite geometric configurations of moving parts in an animate being or a machine onto one object. The recognition of *mechanism* under different geometric states may be fundamental to the development of animal and human brains and is therefore likely the result of natural evolution.

Humans and animals of many species can recognize other individuals of the same species under different kinematic poses and motions. For example, a child can recognize her mother whether the older female is sitting, walking, standing, or lying down. The child identifies all infinite sets of geometric

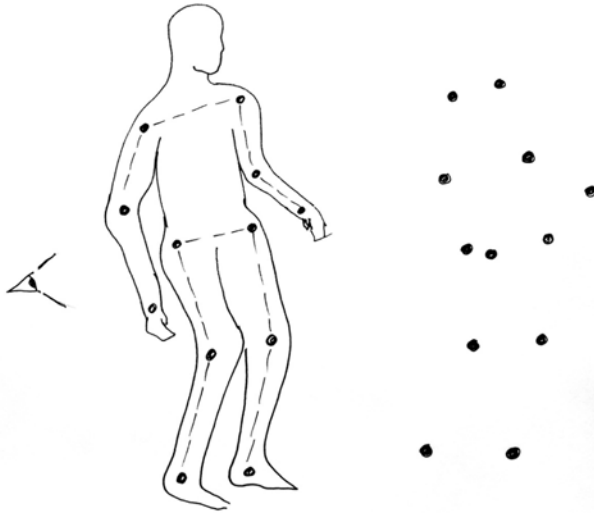

Figure II.2. Moving point lights experiment in kinematic perception of walking humans. (Johansson, 1973, 1975)

poses of the woman with a specific concept called *mother*. Of course, there are other physical attributes that this woman carries such as smell, color, sounds, etc., but her geometric configuration is the greatest changing attribute, that can one moment be as tall as two meters when standing and as small as a meter when crouched down on her haunches. Yet to her child, as well as any other human, she is identified as the same object.

Early work on visual perception includes that of famed psychologist Jean Piaget (1969). In Chapter V of his book *The Mechanisms of Perception*, he described the study the human perception of a rotating square. For slow rotation the subject can distinguish the square but for higher motions the mind sees the image as a fused composite of many squares. The ability of the brain to recognize branched linkage systems in kinematic motions such as walking humans or animals became a subject of much research in the 1970s. Gunnar Johansson (1973, 1975) of Sweden published the results of experiments known as ‘*visual motion perception*’. Observers were asked to recognize a walking figure from the motion of a set of twelve moving light points on the figure (Figure II.2). Observers were shown a different number of sequential point light display images of moving humans as well as at different rates. Most subjects were able to immediately identify the light patterns as belonging to a walking human. He concluded that the brain needed only 100–200 ms to organize the set of light points into a coherent object.

Since these studies, hundreds of similar experiments have been carried out and published in journals of cognitive science, neuro-psychology, psychophysics and computer science. All these studies confirm the ability of humans and some animals to recognize kinematic motions of moving limbs and legged creatures and interpret from scant sensory data, the direction of motion, age, sex and even the emotional state of the walking figure. Although there is much debate as to how the brain accomplishes these tasks, the fact remains that humans can recognize animate objects from a sequence of kinematic sensory information.

There is evidence that humans can recognize an object from kinematic motion of a small sample of light-points on the object but cannot recognize the object from a *stationary* set of light-points. Although there are theories that processes of form recognition in the brain occur in a different way than motion recognition, experiments on the visual perception of motion suggest that information about motion plays a role in recognizing forms (Grese and Poggio, 2003).

In the last decade research into visual perception using point-light experiments have shown that human subjects can also recognize animal gaits. Recent research at the Ruhr Universität in Germany shows that human observers can even distinguish the size of the animal from sparse point-light kinematic information (Jokisch and Troje, 2002). In other studies, subjects could perceive the size of an oscillating pendulum from a set of light points attached to the pendulum.

To add further evidence for innate motion perception are recent experiments on neural activity in the brain in human subjects while they are analyzing moving dot images of biological and non-biological motions. These studies use so-called functional magnetic resonance imaging, or fMRI, to map neural activity in the brain. The outer region of our brains, called the cerebral hemisphere has regions called lobes: frontal, parietal, occipital and temporal. Scientists in France, the United States, the UK and Japan have identified a region called STS or Superior Temporal Sulcus (a fold in the temporal lobe) that exhibits activity during fMRI for recognition of biologically based point light motions (see e.g. Grossman et al., 2004). Some studies of point light motions have used computer generated human motions as well as robot walking. None of these studies however have used point-light motions experiments from simple or complex mechanisms.

If one accepts the idea that the brain encodes topological or geometric properties into one construct called a moving human, then it is not difficult to imagine that this ability of the brain can be extended to inanimate assem-

blages of links that we now call mechanisms and machines. The ability of humans to create inanimate mechanisms as precursors to machines are likely tied closely to our own natural evolution as animals and humans and less likely the result of some spontaneous genius inventor. Thus it should be no surprise that we can see levers and wheeled vehicles in the pictorial artifacts of ancient peoples such as the Babylonians or the Egyptians some three or four millennia ago.

If kinematic mapping is hard-wired into the brain, does this mean that everyone is a natural machine inventor? Cognitive science has provided evidence that humans may have a natural kinematic ‘intuition’ *vis-à-vis* identifying animate motion; thus it may be true that kinematic mapping is also essential to creating tools and machines. But having the ability to speak a language does not mean every human in isolation will begin to speak in some coherent way. The ability to speak is nurtured in a community. This is the old nature-nurture conundrum. To create and produce machines requires not only the natural ability to recognize kinematic possibilities but also requires a community of needs, knowledge and skills required to realize such machine possibilities.

The concept of creation of machines as a function of both evolution of the brain and evolution of societies raises the question of the importance and role of the ‘inventor’ as we now understand it. It is not our thesis that inventors are irrelevant, but that the inventor’s ability to create is preconditioned by the societal context in which they live and are educated. One recent book on creativity and genius has the title *On the Shoulders of Giants* with the subtext that our civilization rests on the accomplishments of a few geniuses. A better analogy than the circus-like image of acrobats standing on top of one another, is that of a *network* of artists, inventors, workshops, scientists and mathematicians, all coupled to one another both in time and location with some nodes in this chain having more outward links than other nodes as illustrated in the influence networks of Leonardo da Vinci and Franz Reuleaux (Figures I.17 or I.18). The inventor node in this societal network is a gatherer of knowledge and techniques from other nodes and a disperser of links to future nodes. If each node in this web adds value to the human store of knowledge and technique, then the inventor is a person who creates a larger ‘added value’ than other nodes. As one popular politician wrote in a book “*it takes a village to raise a child*”; in the case of technology and machines, one might say, ‘*it takes a community to create a machine*’. Reuleaux in a written lecture on technology and society in 1885, wrote that the creation of a technical society

requires scientific and mathematical education at all levels of society from the worker to the engineer to the industrialist.

The development of a *language of machine design* is another point of relevance to ancient machine makers. The evolution of a catalog of sounds and symbols that can be put together in different orders to produce different messages, understandable to another member of the same tribe or language group is one of the great evolutionary milestones of humans. A corollary to this thesis is that humans also learned to create catalogs of tools and mechanisms in order to produce more complex machines. This language of machines has also developed in an evolutionary manner that has accelerated in the last two centuries to a formal methodology to produce our modern technology. This reductionism in machine building began in the golden age of Greece with the identification of so-called ‘simple machines’ at the time of Aristotle and was promulgated several centuries later by Roman engineers such as Vitruvius. A visual, symbolic language of machines developed into a high art during the Renaissance of Leonardo da Vinci and became mathematized in the 19th century beginning with Monge and Willis and accelerated with Reuleaux, Kennedy, Burmester and Grübler at the end of the 19th century. In the late 20th and early the 21st century this language of machines has evolved into a methodology to synthesize new machines using other machines such as computers and rapid prototyping machines.

In constructing a symbol representation of kinematic chains, Reuleaux believed he was creating a *language of invention*. He believed that creativity or synthesis, not analysis, was at the center of machine engineering. Analysis was a necessary handmaiden to synthesis, but not its driver. Today, it is not a matter of whether human engineers can invent new machines but whether it is possible for humans to invent algorithms that will enable a computer to build a new machine (Lipson, 2005, 2006).

In the following sections we review the evolution of machine creation through the Greek and Roman eras. There is also evidence that a similar evolution of machines was taking place in other human communities such as in what is now China (see e.g. Needham, 1965, Vol. 4, Part II, *Mechanical Engineering*). There is evidence that there was a diffusion of technical knowledge between East and West Euro-Asia that helped accelerate the evolution of machine technology (Diamond, 1999).

II.3 ANCIENT GREEK AND ROMAN MACHINES

HOMER: THE ODYSSEY (C. 750–700 BCE)

Although Homer is not known as a mathematician or scientist, his epic stories of Greek heroes and gods contain many details about the human-made environment. For example in the *Odyssey*, believed to be written at the end of the 8th century before the Christian era, the metals gold, silver, bronze and iron are mentioned indicating a substantial metals processing capability. Machines and mechanisms such as textile looms and spinning wheels, locks, wagons and chariots are also described suggesting that there were workshops to produce kinematic objects. Of course the journey of Odysseus takes place on ships and Homer described oar devices, rudders and rigging for sails in his story. Finally there are many varieties of food, grain, wine, olive oil that would require presses and mill stone machines. Tools such as the anvil, hammer, tongs, boring and cutting tools are listed, sometimes as a litany of the technical prowess of the Greeks.

ARISTOTLE [384–322 BCE]

Ancient philosophers in Greece began to codify and apply mathematical reasoning to the design of machines. Of special interest are the so-called simple machines, sometimes listed as the *lever*, *wheel*, *inclined plane*, *wedge*, *pulley* as well as the *screw* and the *roller* (Figure II.3). It is likely that other cultures in the Middle East, Asia, Africa, and the Americas used some of these simple machines, especially the lever, wedge and roller. However the Greeks were unique in that they left a written record of some of their technology and related mathematics. We are fortunate that some of this literature was studied and preserved by the Arabs, through whom these ancient writings were transmitted in the Middle Ages throughout post-Roman Europe. Oddly the European tribes that destroyed most of the libraries of the Roman era, later came to depend on the Arab libraries that had saved some of this literature.

Aristotle was a student of Plato. In contrast to his mentor, Aristotle adopted a more empirical approach to nature and science. He was a teacher of Alexander and wrote his philosophical works during and after the reign of Alexander the Great. Of particular interest to us is his *MHXANIKA*, or *Mechanical Problems*, published in modern editions under the *Minor Works* of Aristotle. However one translator of the English Edition, W.S. Hett of Oxford (1936), notes that this work was likely rewritten by followers of Aristotle,

SIMPLE MACHINES

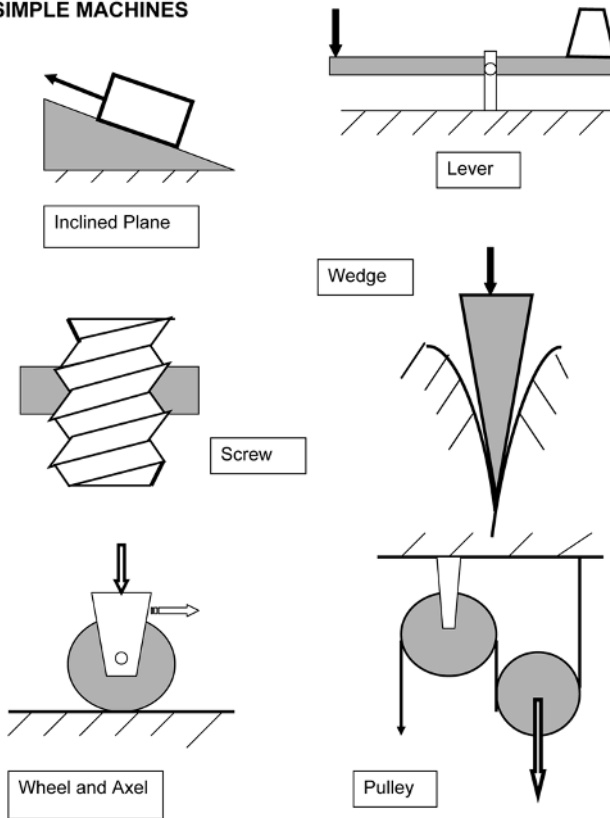

Figure II.3. Six simple machines of antiquity

called the Peripatetic School named after the ‘peripatos’, or walk, in the garden of Aristotle’s school in Athens where he often met with his students. In *Mechanical Problems* there is listed a number of mechanical devices that were derived from the simple machines listed above. Aristotle’s book provides evidence of the ubiquitous presence of machines in antiquity, some 2300 years ago, based on simple geometric principles. This list of machines includes those in Table II.1.

Earlier references to some of these machine elements can be found in the artifacts of archeology. The wheeled vehicle and the potter’s wheel go back at least 5000 years (Figure II.4). The remains of a wheeled cart have been found in a royal tomb in Mesopotamia, dating from the 3rd millennium BCE. Spoked wheels can be seen in pictures in Egyptian grave steles dating from 1200 BCE and in China date from at least 1200 BCE. A spoked-wheel, horse drawn chariot can be seen in a carving on an ivory chest from Cyprus dating

Table II.1. Machine artifacts in Aristotle's *mechanical problems*

Lever	Rollers to move weights
Friction wheels	Wheel and axel for carts
Balance to compare weights	Slingshot and catapult
Oars on a ship	Spindles
Rudder on a ship	Windlass
Potter's wheel	Wedge, Axe to cut wood
Pulley	Forceps, pincers, nutcracker



Figure II.4. Wheeled chariot, Neo-Assyrian, 800 BC (Pergamon Museum, Berlin)

from 1200 BCE. A prehistoric balance and weights from Egypt dates from the fifth millennium BCE. The balance is based on the lever and so is the oared galley of which there is pictorial evidence in Mesopotamia dating from the 7th century BCE (see Singer et al., 1954, Vol. I).

The School of Aristotle treatise takes the form of a set of questions and statements followed by mathematical discussion. For example, in the case of the lever, he writes

Among the problems in this class are included those concerned with the lever. For it is strange that a great weight can be moved by a small force, and that, too, when a greater weight is involved. For the very same weight, which a man cannot move without a lever, he quickly moves by applying the weight of the lever.

In another example, “*Why are round and circular bodies easiest to move?*” Or “*Why are great weights and bodies of considerable size split by a small wedge?*” Much of the ensuing discussion related to these questions is about the geometrical properties of the lever and the circle. Aristotle and his followers were not trying to design machines for particular applications, but were using the technology of the times to illustrate certain geometric problems. *Mechanical Problems* is more a mathematics text than an engineering manual. The focus of the Greek mathematics was mainly on the force equilibrium nature of the simple machines and less on the kinematic character of the device. This work may have been the first that tried to place the theory of the lever and other simple machines on a rational footing, a task that was accelerated by the Schoolmen of the Middle Ages as well as Leonardo and other Renaissance artist-engineers.

THE ALEXANDRIAN SCHOOL AND LIBRARY (300–50 BCE)

Much of our knowledge of Greek machine engineering is traced to the great Library of Alexandria located on one of the western tributaries of the Nile river in what is today Egypt. Alexander the Great [356–323 BCE] founded the city around 331 BCE. Sometime during the reign of the king Ptolemy I Soter, the Library was established by an Athenian exile Demetrius Phalereas. It is estimated that there may have been three separate libraries holding from 400,000–700,000 scrolls on papyrus. Alexandria was a major port on the eastern Mediterranean Sea and if there were books and scrolls on visiting vessels they would be copied by scribes for the Library. In addition there were 50–100 scholars in residence studying poetry, mathematics and astronomy. One of the early tasks of the Library scholars was to translate the Old Testament

from Hebrew into Greek. Demetrius is believed to have studied with the Peripatetic School in Athens before his exile and wanted to establish a similar school in Alexandria based on Aristotelian ideas.

Among the great scholars that studied there were Euclid, Archimedes, Ctesibius, Philo of Byzantium and Hero. It is likely that the study of machines was at first an outgrowth of mathematics research and its application to mechanics rather than as an institute to produce useful machines. In modern histories of technology the idea of ‘inventor’ is an important attribution. For example we refer today to the Archimedian screw pump or the Ctesibius water clock as if there were an ancient patent office where inventors laid claim to a specific device or machine. Most of these men were likely mathematicians who sought to illustrate the power of mathematics by describing some ingenious machine that originated from an understanding of geometry, trigonometry and arithmetic. They also had access to scribes who could record their ideas and teachings as well as to artisans who could construct models and devices to illustrate their theoretical concepts. These mathematician-engineers probably also recorded and described concepts for machines that were already in practical use. We cannot say with any authority that some particular author ‘invented’ a machine just because it is described in his writings. In many cases we do not have original writings but only copies in Arabic or Latin. Also much knowledge about machines in antiquity comes from commentaries such as Vitruvius.

The machines described in these writings often were related to ancient industries such as pumps for irrigation, presses to produce wine and oil, cranes to lift cargo into and off of ships, wheeled vehicles for transportation and of course war machines. There were also machine curiosities such as a water organ, water clocks, and automata birds and animals that were designed to entertain the royalty who were supporting these scholars.

There is a continuity of ideas in machine engineering from Archimedes to Philo of Byzantium. But during the first century there appears to be a gap between Philo [d. 180 BCE] and Hero (c. 62 CE). There are several stories as to what happened to this important treasure of the ancient world. One story tells of the burning of the library around 47 BCE during the campaign of Julius Caesar. Others say much remained during the Muslim ascendancy.

ARCHIMEDES [287–212 BCE]

Archimedes was born in Syracuse on the Greek ruled island of what is now Sicily. His father was reported to be an astronomer. Many historians believe that Archimedes visited Egypt and studied in the great scholarly city

of Alexandria on the North coast of Africa. He knew several mathematicians in Alexandria who had studied the geometric works of Euclid. There are a number of surviving books attributed to Archimedes on the subjects of mathematics and mechanics such as treatises on the spiral, sphere and cylinder, equilibrium of bodies and floating objects. He is credited with some of the basic ideas of hydrostatics. His work as a designer of machines is usually ascribed through other ancient writers. For example Plutarch in writing about the Roman general Marcellus tells how Archimedes designed machines for war against the Romans in 212 BCE. These included machines to hurl missiles and large stones at the enemy as well as an underwater mechanism of levers and pulleys that could overturn a ship entering a harbor. He is also credited with using the compound pulley as well as a screw-shaped device to pump water, that is called today an 'Archimedes screw', although some historians believe that Archimedes saw this device in use by Egyptian farmers to irrigate their fields. Of Archimedes mathematical works there is a clear record. But because of his fame in this area as well as in mechanics, many have been willing to credit him with inventions that may well have been familiar to skilled artisans, farmers and trades people of the time. A popular website in English maintained by the Technology Museum of Thessaloniki is called 'Ancient Greek Scientists' and may be found at www.tmth.gr.edu. Descriptions of the lives and works of most of the engineers in this section may be found at this site; although the visitor should discount some of the superlatives in the narratives.

CTESIBIUS [3RD C. BCE]

Ctesibius is another Alexandrian engineer who is often credited with machine inventions. There are no extant works to document these inventions. Nevertheless, he has been identified with clock mechanisms and geared devices. In the Roman work by Vitruvius Pollio (circa 27 BCE), Ctesibius' water clock or clepsydra, is described as the first to have a regulator that would maintain a constant head of water in the effluent part of the clock in order to improve the accuracy. Otto Mayr (1969), an authority on the origins of feedback devices in antiquity, questioned the interpretation of Vitruvius' description of Ctesibius' water clock regulator. Ctesibius is also recorded as the inventor of various automata or moving mechanical animals driven by his clock. He is also credited with a piston pump with a check valve, that became the forerunner of later designs by engineers in the Renaissance. He wrote a treatise on pneumatics in which he discovered the compressible properties of air and proposed compressed air cannons.

HERO OF ALEXANDRIA [1ST C. CE]

Hero is one of the few Greek engineer-mathematicians whose written works have come down to us. Some historians credit him with establishing a technical school in Alexandria. His books include works on pneumatics, mechanics, and geometry. Among his dynamic machines are catapults and balisti. These devices could launch both stones and arrows. He also wrote a treatise on automata. An Italian translation of 1589 by Bernardino Baldi contains a drawing attempting to reconstruct one of these devices for a fountain offering wine and milk with a rotating figure on top. The automata are driven by a hidden falling weight that creates a torque on a rotating cylinder. Hero is also famous for his steam-powered aeolipile, a reaction wheel steam turbine often cited as one of the origins of the steam engine (Drachmann, 1963).

VITRUVIUS POLLIO [C. 37 CE]

Vitruvius was one of the earliest writers whose work has survived through the centuries in the areas of architecture and machine design. Although we know little of his personal life, his set of ten books on architecture and machines is the only complete set of its kind to come down to us. Marcus Vitruvius Pollis is believed to have worked during the reign of Julius Caesar and Octavian [c. 44 BCE]. Under the former he likely served as a military engineer and under the latter as a designer of water supply systems for Rome. Nothing of an architectural nature of his has survived today. In *de Architectura libri decem* (c. 27 BCE) Book X are descriptions of machines of Roman times as well as their methods of construction. There is some discussion of pumps in Book VIII, as well as water clocks in Book IX. In Book X, Vitruvius presents encyclopedic descriptions of many applications of machines. Unfortunately this manuscript does not contain sketches or drawings. In the Renaissance, authors of translations of Vitruvius' works have added fanciful drawings of his imagined machines. Francesco di Georgio Martini, a predecessor of Leonardo was one of the first architect-engineers to translate Vitruvius.

It is interesting to read Vitruvius' descriptions of machines in terms of Aristotle's language of simple machine elements. One can also read of the use of toothed wheels or gear systems in water mills. Cranes, pumps, lathes, odometers and war machines are described in terms of levers, wheels, pulleys, screws, etc. Vitruvius makes clear that in Roman times the design of machines required skills in mathematics, especially geometry and arithmetic: "*the rules will be only understood by those who are acquainted with arithmetical numbers and their powers*" (Translator, Bill Thayer; www.ukans.edu/history). A similar quotation can be found in the Notebooks of Leonardo da Vinci.

PAPPUS OF ALEXANDRIA [C. 320 CE]

Around the first century of the Christian era, Hero (Heron) wrote his famous books on pneumatics, war machines, automatic devices, mechanics and a textbook on geometry. An important work after Hero of Alexandria and Vitruvius, are the writings of Pappus of Alexandria in the 4th century. His *Mathematical Collections* consist of eight books. Book 8 contains the most relevant writing about machines. The other seven books cover mathematical questions and other topics. Included in Book 8 is a discussion of the inclined plane and the spiral. In a quotation from Book 8 on the nature of mechanics, we learn something about the different machines in use at the end of the Roman Empire.

Of all the arts, the most necessary for the uses of life — are: that of the makers of mechanical powers, they themselves being called mechanics by the ancients (for they lift great weights by mechanical means to a height, contrary to nature, moving them by a lesser force);

that of the makers of engines necessary for war, also called mechanics (for they hurl missiles both of stone and iron and such like objects to great distance, by means of the instruments, known as catapults, that they make):

in addition, the art of those who are in turn especially called makers of machines (for water is raised from a great depth more easily by means of the instruments for water-drawing which they build). The ancients also call mechanics the wonder-workers, of whom some practice their art by means of air, as Hero in *Pneumatica*; some by means of strings and ropes, thinking to imitate the movements of living bodies, — or by telling the time by means of water, as Hero in *Hydra*. (See Cuomo, 2000)

From this description, one can picture in Roman times, machines such as construction cranes, catapults, pumps for lifting water, and water clocks. Pappus also described a series of cogwheels and a crank attached to a worm drive, or endless screw, for lifting heavy weights called a *barulkos* which he attributes to Hero. This mechanism is drawn in Beck's *History of Mechanical Engineering* (1899). Pappus also attributed a compound pulley to Archimedes called a *polyspaston*, which was also described by Hero. Pappus also quotes Archimedes' famous phrase "Give me a place to stand and I will move the Earth."

The dates of the lives and writings of these early chroniclers of the history of machines are debated by historians, as well as the attribution of the invention of many devices. The important point for this treatise is the fact that knowledge of basic simple machines and mechanisms such as compound pulleys and toothed wheels existed in ancient times. The understanding of ancient engineers about the ratio of diameters of toothed wheels and the force lifting advantage of the cranked pinion and gear or series of gears is evidence of the beginnings of engineering mathematics and science long before the age of the Renaissance engineers.

II.4 MACHINES IN THE BIBLE

Records of the use of machines can be found in the sculptural and artifact remains of the great civilizations of Babylonia, Egypt and Greece in the form of wheeled chariots, ships and other battle related technology. Written records of machines in ancient civilizations are more difficult to come by. One such record that purports to cover several millennia is the *Bible* in its Old and New Testaments. The *Bible* is important because the Jews were living at one time or another in Babylonia, Egypt and even in the North Africa Greek city of Alexandria where Hero wrote his famous five books of mechanics and machines. Yet like so much of literature and art today, the Bible does not contain a lot of references to the technologies of the times. With its origins in an oral tradition, the biblical scribes described the relationship between humans and their God as well as interactions among humans themselves and less so the technology of the times in contrast with the work of Homer.

There is reference in the Bible to skilled crafts persons such as carpenters, potters, weavers and spinners, tanners, jewelers and masons. Jesus is described in *Mark 6:3*, by the Greek word for carpenter, *tekton*. Explicit descriptions of machines that craftspeople used in their trades are more difficult to find. If there is information about technology, it usually comes in the context of stories about human conflicts. Thus in telling about a war, there is often mention of the use of iron chariots as in the following:

THE BOOK OF JUDGES (KING JAMES VERSION)

1:19. “And the Lord was with Ju’-dah and he drove out the inhabitants of the mountain; but could not drive out the inhabitants of the valley, because they had chariots of iron”.

4:7. “And I will draw unto thee to the river Ki’shon Sis’-e-ra, the captain of Ja’-bin’s army with his chariots and his multitude; and I will deliver him into thine hand.”

Chariots are also mentioned in *Judges* in sections 4:13, 4:15, 4:16, and 4:28 as well as in *The Second Book of Samuel* (*The 2nd book of Kings*, section 10:18).

Another crude machine is the slingshot, which is a kind of precursor of the double pendulum *trebuchet*-throwing machine. The use of the sling-throwing weapon is described in the famous story of David and Goliath in *The First Book of Samuel* (*The 1st Book of Kings*), 17:49, and 17:50.

Indirect use of machines can be inferred by references to mills for grinding corn or olives or to potter's wheels

An early passage from *Exodus* 31:3–5, speaks of workmanship and the use of tools:

And I have filled him with the spirit of God, in wisdom, and in understanding and in knowledge and in all manner of workmanship; To devise cunning works, to work in gold, and in silver, and in brass; And in cutting of stones, to set them, and in carving of timber, to work in all manner of workmanship.

Reference to the so-called simple machines, lever, wedge, wheel, pulley and screw are found in several sources in the Bible as in the description of a balance (lever) in *Isaiah* 46:6

They lavish gold out of a bag and weigh silver in the balance.

There seems to be fewer direct references to technology in the New Testament. In *Revelation* there is some mention of 'vessels of brass and iron' as well as 'horses and chariots'. There is less exhortation to develop good 'workmanship' as in *Exodus*, there is instead a plea for a more passive approach to life as in the famous flower power lesson of *Luke* 12:27

Consider the lilies how they grow; they toil not, they spin not; and yet I say unto you, that Solomon in all his glory was not arrayed like one of these.

Here we can infer that people used some form of spinning device to make yarn and weave cloth for clothes.

In summary, it is clear that the Bible stories have a different purpose than to describe the everyday life of ancient peoples and their tools and technology. We are left with the records of the ancient engineers Archimedes, Hero and Vitruvius who gave mankind a more detailed record of the origins of machine design and construction.

II.5 ROGER BACON ON MARVELOUS MACHINES IN THE 13TH CENTURY

The period between the decline of the Western Roman Empire to the beginning of the Renaissance 500–1500 has been called the Dark Ages or Middle Ages in history texts. This often reflects the decline in the quality of painting, sculpture and literature from the standards of the Greek and Roman eras. Was this period a ‘dark age’ for machine development? Recent scholarly evidence suggests that the Middle Age period, 1000–1500, saw the two developments that helped pave the way for the machine age of the Renaissance: (i) the emergence of the idea of progress and experimental scientific study, and (ii) the development of a craft and guild infrastructure that provided the technical skills and materials to enable complex machines to be built. The idea of progress and scientific thought emerged from Christian church scholars in their attempt to reconcile the biblical message with the realities of the physical world. On the other hand, the craft and materials technology developed out of the mercantile trade system that connected the new city and urban network across Europe and the eastern world.

Historical evidence for progress in machine evolution and invention prior to the Renaissance is sparse but some records exist. For example, during the reign of William the Conqueror around 1086 in England, a survey of his lands was commissioned in a document called the *Domesday Book*. In this book over 5000 windmills are recorded, certainly not a dark ages for wind power and machine construction. In the 13th century there is a larger body of documents about machines especially in the Arabic literature. In 1204 Ibn al-Razzar al-Jazari wrote a manuscript called *The Book of Knowledge of Ingenious Mechanical Devices*. The text is accompanied with drawings that describe many water and hydraulic devices for pumps and fountains. Another text is one by Villard de Honnecourt called by some *The Sketchbook* written sometime around 1225, that contains sketches of architectural problems as well as a few machines (Figure II.5).

The 13th century was also an exciting time of construction of the great gothic cathedrals of Europe. Ste-Chapelle in Paris was consecrated in 1248 and the first stone laid for the south transept of Notre Dame cathedral in Paris was set in 1258. These enormous structures required machines to lift massive stones tens of meters in height. Several paintings of the period show these churches in partial construction along with cranes and other machines.

In the realm of ideas, several important philosophers presented arguments for a more experiential and experimental search for truth and science. For nearly a millennium, the tools for ascertaining truth in Christian Europe lay

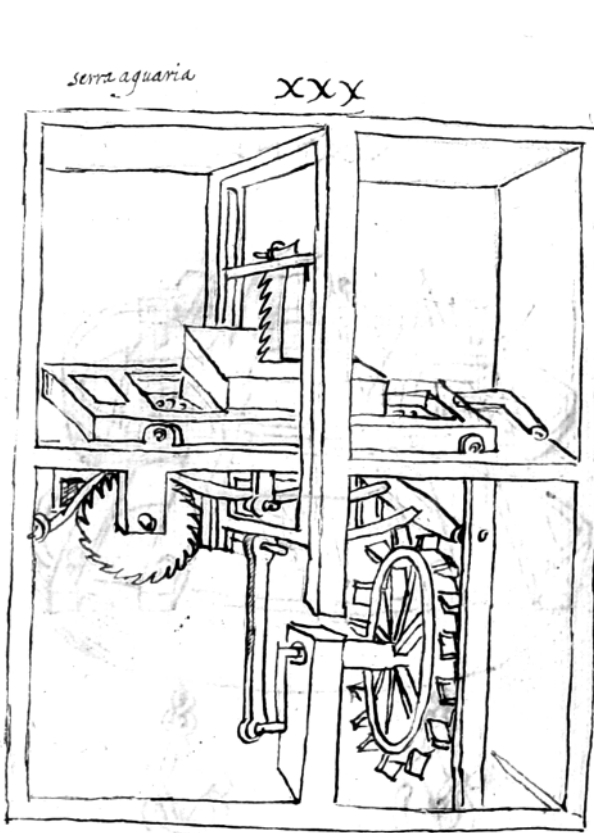

Figure II.5. Lumber-cutting machine drawing by Francesco di Giorgio di Martini (15th C.) after Villard de Honnecourt (c. 1225)

exclusively with the Church of Rome and the approved Scriptures. Beginning in the 13th century, churchmen such as Robert Grosseteste of Oxford, William Auvergne of Paris, Albertus Magnus of Cologne and Roger Bacon of Oxford began to reconcile the Christian view of the world with Aristotelean philosophy, which emphasizes the use of experience and experiment.

Roger Bacon of England was born into a wealthy family around 1220. He studied in Oxford and Paris and taught at Paris until 1247 when he returned to Oxford and entered the Franciscan Order around 1250. Around 1265, Pope Clement IV asked Bacon to write an encyclopedic work on the sciences. Bacon produced three works *Opus Majus*, *Opus Minor*, and *Opus Tertium*. Bacon is credited by some with laying the conceptual foundations of

the scientific method. He had interests in mathematics, optics, and chemistry. He also entertained beliefs in alchemy, astrology and magic that made him a controversial figure in his Order. He is also known to have written about the production of gunpowder, the construction of lenses and microscopes, as well as flight by humans. In his famous *Epistola de secretis operibus artis et naturae*, or ‘on the wonderful works of nature’, he spoke of many fantastic machines and inventions that he believed were possible. A selection of this work below shows the imagination and science fiction – like thinking of 13th century educated men.

... It is possible to build vessels without oarsmen so that very big river and maritime boats can travel guided by a solitary helmsman much more swiftly than if they were guided by men. It’s also possible to build wagons that move without horses by means of a miraculous force. And I think that the reaping chariots used by the ancients must have been made like this. It’s also possible to construct machines for flight built so that a man in the middle of one can maneuver it using some kind of device that makes the specially built wings beat the air the way birds do when they fly. And similarly it’s also possible build a small winch capable of raising and lowering infinitely heavy weights ... it’s also possible to build devices for walking on seas and rivers and for touching their bottoms without taking any risks. And Alexander the Great doubtlessly used these instruments to explore the ocean floor as the astronomer Etico narrates. In fact there is no doubt that such instruments had been built in ancient times and are still being built today, except for the flying machine that neither I nor anyone I know, has ever seen. I do know a scholar who tried to build this instrument as well. It’s possible to build an infinite number of bridges, for example which, can be stretched across rivers without using any kind of pillars or supports, and of unheard of machines and inventions. (Cited in *Leonardo da Vinci’s Machines*, by Marco Cianchi, 1995, p. 12)

Another famous quotation of Bacon that illustrates the beginnings of the scientific age is the following:

Of the three ways in which men think they acquire knowledge of things, authority, reasoning and experience, only the last is effective and able to bring peace to the intellect.

Leonardo would echo this philosophy two centuries later.

II.6 MACHINES OF THE MIDDLE AGES

Historians often call the centuries between the fall of the Roman Empire 500 AD to the Renaissance c. 1500, the ‘Middle Ages’ or medieval period and the period 500–1000, the ‘dark ages’ in European history. Certainly during this later period there were gruesome tales of black plague, starvation, and countless wars in a constant battle between ethnic tribal cultures and the new religious-based empires of Islam and Christianity. By the 10th century, there emerged a number of European quasi-states in England, France and Spain and a German led Holy Roman Empire in middle Europe. With such goings on, one might ask, was there any progress in the evolution of machines between the time of the Roman Vitruvius and Leonardo da Vinci?

During the last half of the 20th century scholars have provided evidence and analysis that the Middle Ages was a period that established the technical foundations for the machine designs of the 15th and 16th century engineers, including Leonardo da Vinci (see e.g. Singer et al., 1956; Clagett, 1959; Gille, 1966; Hall, 1976; Gimpel, 1976; Gies, 1994). Two sources for this conclusion are the machine drawings of Villard de Honnecourt (c. 1225) and Guido da Vigevano (1335).

During the early period of the Middle Ages the Arabs developed many hydraulic machines for pumping water, water clocks or clepsydra (e.g. Al-Jazari c. 1206) and automata (Banu Mussa, c. 850). In Europe advances were made in agriculture, textiles, mining and metallurgy as well as mechanical clocks that laid the foundations of the machine revolution of the Renaissance. In England, 5624 water mills were documented extensively in the so-called Domesday Book of William the Conqueror in 1086. After the millennium, in Europe, many crafts guilds were formed that codified technical knowledge necessary to build, run and maintain machines and related technologies. In so far as the machines of Leonardo da Vinci are concerned, the advances during the Middle Ages in textile machines, metalworking and clocks provided the basis for Leonardo’s ingenious designs and beautiful drawings of machines in these technologies in the late 15th century.

History is usually written by scholars trained in the humanities and having observed the decline of art, sculpture, literature and architecture in the early Middle Ages from the zenith of the Roman Empire, one might understandably conclude that technology also declined during this period. Studies show that this was not the case. The Romans used a lot of cheap slave power, whereas in the Middle Ages, mankind learned how to make things more efficiently with machine technology.

After 1000 AD, technological prowess began to shift from the Arab Empire to Europe, based in part on the development of cities, trade and a belief in progress. Some advancement in both science and technology actually grew out of the life of monasteries in which the monks and nuns learned how to manage waterpower, grow their own food and develop skills such as textiles and printing. These religious centers were also the seat of learning through so-called monastery schools that had extensive libraries and had translated the ancient works of the Greeks and Romans, including Euclid, Archimedes and Hero.

In the use of technology the monasteries of the Cistercian Order were noted for their embrace of water technology. For example, in Singer's encyclopedic work, *A History of Technology* (1956), there is a quote from the Clairvaux Abbey in France on the use of waterpower:

The river enters the abbey as much as the wall acting as a check allows. It gushes first into the corn mill — where it is very actively employed in grinding the grain under the weight of the wheels and in shaking the fine sieve, which separates flour from bran. But the river has not finished its work, for it is now drawn into the fulling machines following the corn-mill. Thus it raises and lowers alternatively the heavy hammers and mallets—. Now the river enters the tannery—. Then it divides in many branches—, whether for cooking, rotating, crushing, watering, washing or grinding, always offering its help and never refusing.

Both the Arabs and the Chinese developed water clocks. But the origins of the mechanical clock date from around the 13th century in Europe perhaps as a need of monastic communities to keep track of time for prayer services. The so-called verge and foliot escapement allowed the use of a falling weight to measure intervals of time. This technology required the development of skilled craftsman to make precise wood and metal parts for machines, including gear trains.

A key technology in any era is the development of power sources. The water mill appeared during the late Roman era but was improved and disseminated widely in Europe during the Middle Ages (e.g. Singer et al., Vol. II, Chap. 17). Some form of windmill has been attributed to the early Mediterranean cultures but the windmill saw its greatest advance in Europe during the late Middle Ages. These power sources, each with the equivalent of 50 horsepower gave the European peoples a significant technological advantage over other cultures without which the Renaissance and the age of discovery would not have been possible as we know it today.

GUIDO DA VIGEVANO OF PAVIA (C. 1335)

The written record of the Middle Ages is not as extensive as the later Renaissance and the era of the printed book. There may have been many other architects, artists and engineers who engaged in machine design. In Guido da Vigevano we have both an engineer and physician who wrote a treatise on both military and medical advice for King Phillippe VI of France for a crusade that he never got to take. This manuscript of 23 folios contains medical advice to survive in the dry, hot Mediterranean as well as drawings of siege machines and other war technology.

Guido da Vigevano was born around 1280 and studied medicine at Bologna. There is a copy of his book in Paris and another in Turin. His text and drawings have recently been translated into Italian and English (see Giustina Ostuni's *Le macchine del re*, 1993, and A.R. Hall, 1976 for an English translation of the military chapters, 'De Rebus Bellicus'). They describe floating pontoons, mobile assault towers, propeller driven boats, and a gear driven assault chariot to carry a platoon of soldiers. What is perhaps unique about this book is that Guido designed these military machines and structures to be portable and prefabricated for transport into battle on horses. According to Hall (1976b) Guido designed special joints (hinges and butt joints) to assemble the pieces and recommended iron for hinges and shafts. It is worth noting that foldable structures are a form of kinematic mechanism. In Chapter III there is a description of bridges for dry land that can be folded up and carried on horses. In Chapter V are described siege ladders that can be folded and carried on horses. Chapter VII discusses folding bridges for rivers, and Chapter VIII describes making boats that can be folded for horse transport.

More fantastic machines are described in Chapters XI, and XII in which there are drawings of 'assault wagons' which are self propelled and 'assault-cars' propelled by the wind.

Guido da Vigevano's drawings accompany the text on the same manuscript page (some can be seen in Bertrand Gille's *The Renaissance Engineers*, 1966), and like those of Villard de Honnecourt before him, are very two dimensional and without perspective and it would be hard for modern engineers to actually build anything from them. The text, according to Hall (1976b), however contains many technical terms that show that Guido was familiar with workshop and artisan practices such as lantern pinions and crown wheel gearing.

The comments of the translator A. Rupert Hall (1976b) suggest that later Renaissance engineers, such as Roberto Valturio, Francesco di Giorgio Martini and even Leonardo da Vinci, copied many elements in Guido da

Vigevano's work either directly or through copies of Guido's work. This further supports the theory of technical evolution of concepts of machine design.

KONRAD KYESER AUS EICHSTÄTT [1366–CA. 1405]

Another work of German origin that likely influenced Leonardo and other machine engineers of the early Renaissance is the *Bellifortis* of Konrad Kyeser. Kyeser was born in the Bavarian town of Eichstätt, between Munich and Nuremberg. His dedication of *Bellifortis* to Emperor Ruprecht of Palatinate is dated 1405, but the year of his death is not known (see e.g. Gille, 1966). Kyeser had likely served as a soldier and later as a military engineer. It is not known whether these designs were his own or copied from existing technology. The book and parts of the book were widely copied and printed in the century after its appearance. Some of his designs seem to be reflected in the later work of the Italian Mariano Taccola (1449).

Kyeser's *Bellifortis*, like that of Guido da Vigevano's, contains designs for machines, weapons and siege strategies for war and methods to attack fortified castles. There are designs for pontoons to bridge rivers, cross-bows and trebuchet machines for hurling objects at castles. From the point of view of machine elements and mechanisms, Kyeser made use of the lever, crank, pulley systems, wheeled carts, pumps, the lazy tongs, sliding joints and other basic machine elements. Leonardo's list of basic elements spans a greater set of possibilities partly because his machines were intended for a wider range of applications besides war, including textile machines, metalworking, clocks and other measuring instruments. According to the da Vinci scholar Igor Hart (1925), it is likely that Leonardo and other early Renaissance engineers, such as Francesco di Giorgio Martini, had access to copies of Kyeser's work as some of his designs show up in a different form in these later works.

Conceptually these pre-Renaissance machine books show that there was no lack of engineering imagination for daring designs in the high Middle Ages. As Gille and others have observed, after looking at these designs, one is forced to mute the praise for the ingenuity attributed to later machine designers such as Taccola, Francesco di Giorgio and even Leonardo da Vinci. A clear evolutionary path in machine concepts can be followed from the 13th to the 15th centuries and on into the detailed machine drawings of Besson and Ramelli in the 16th century.

II.7 SCIENTIFIC AND TECHNICAL MILIEU IN THE RENAISSANCE MACHINE AGE

Machines are created by a human community in a historical context with scientific, industrial, political, economic and cultural factors contributing to the advance of technology. Inventors and engineers approach a new machine with a given set of artifacts and tools as well as scientific concepts and technical knowledge that have evolved over many generations. At the same time, new machines are created by a vision of the future often by a few individuals with talent and genius; they imagine something new that exceeds the capabilities of current machines, which pushes the boundaries of performance, saves money or creates a new need. Out of this tension between past constraints and future hopes emerges a new machine.

It is not enough to list dates and inventors of certain machines if one is to understand the history of technology or the pathways to the creation of new technology. One must try to answer a host of questions that will shape this understanding:

- What were the technical and economic factors driving the invention?
- What was the state of technical knowledge at the time of the invention?
- How was technical knowledge preserved and transmitted?
- What were the institutions for communicating technical knowledge?
- Was the political and religious environment conducive for creative thinking?
- Who controlled capital and access to technical processes to produce the machine?
- What were the scientific and technical networks outside of the inventor's locality?
- Who were the people that mentored or helped the inventor?
- What was the influence of moral, societal and religious values on the inventor?

One could add a dozen or more questions to this list. But we will try to answer a few of these questions in the context of Leonardo's generation, what one might call the Renaissance Age of Machines. This review of the background of Leonardo and the Renaissance can only skim the surface of this topic. The reader is referred to more extensive books on the life and times of Leonardo da Vinci, such as the biography by Ivor Hart (1961), Charles Nicholl (2004) or a review of Renaissance Europe by Rice and Grafton (1994).

The source of political and financial power in Leonardo's Florence was the Medici family. Cosimo di Medici came to power in 1434 and died in

1464 when Leonardo was 12. Lorenzo the Magnificent came to power in 1469 and died in 1492 ten years after Leonardo had left for Milan to work for another ruler Ludivico Sforza. Florence's wealth and power came from its banking and manufacturing enterprises. Because of the Church's ban on usury, banks made money through having international branches in which they exchanged currency and goods, a system that hid the payment of interest on loans (see e.g. *Medici Money*, by Tim Parks, 2005). The Medici branches extended from Florence, Geneva, Bruges and London to the north and west, and to Venice with its contacts with the eastern Islamic and Asian trade. There were pathways for the exchange of not only money and goods but also ideas and technical knowledge such as that connected with machines.

To determine what economic pressures led to a specific machine invention we can ask what needs, products or services were in demand during the 15th century of Leonardo. We know that there were constant wars and battles that created a demand for military engineers and military machines, not too different from the present. Milan, for example, where Leonardo spent 17 years, was a major producer of hand weapons such as swords and spears. There were also production industries that used machines such as mills for grinding corn, spinning silk thread, pumping water or pulverizing chemicals and ores for metals. New technologies were emerging that would create new demands such as printed books and clocks for private use.

One example of economic influence on invention is in Leonardo's drawings, some of which were related to textile machines (Ponting, 1979). During the 15th century, Tuscany was a major producer of textiles at Florence and Lucca. Florence was known for its silk industry. Milan was also a producer of wool and textiles. The manufacture of textiles involved numerous steps such as carding, spinning, twisting, weaving and finishing or fulling and each step in the process created a technical need for new machines. Leonardo's Notebooks contain mechanisms for spinning and twisting thread, for weaving, or a cam operated hammer for beating finished fabric. The inspiration for these devices did not emerge out of a vacuum, but out of the realities of the Tuscan economy.

Clock mechanisms are another technology present in Leonardo's Notebooks. He has numerous designs for clock escapements, gear work and a fusee device to equalize the clock spring torque as it runs down. Early clocks for churches and public buildings, known as tower clocks, were large devices unsuited for private homes. Around the 14th–15th centuries, smaller clocks for private use began to be manufactured which created a demand for new designs and inventions. Tower clocks in churches were used to call parishioners

to prayer and service. The desire for smaller personal clocks arose with the growth of the mercantile class and trade within and between city-states.

The preservation and transmission of technical knowledge in the Renaissance was influenced dramatically by the emergence of the typeset printed book, originated by Gutenberg at Mainz around 1450. Up until this time, books were either hand written or block printed and were expensive. Only church related libraries and wealthy patrons owned books. By the end of the 15th century there were over a 1000 book printing workshops in Europe turning out thousands of books. During the following century, numerous authors such as Besson, Ramelli and Zonca produced popular works known as a 'Machine Book' or *Theatrum Machinarum*, which contained hundreds of pictures and diagrams of machines for many uses (see Section II.9). Even without the book press, there were official centers for copying important manuscripts called *scriptoria*, such as the Benedictine monastery of Monte Oliveto Maggiore. It is likely that the drawings of Taccola and Francesco di Giorgio were copied there. There were also libraries of the rulers in Siena, Florence, Milan, and Urbino where architect-engineers could get access to the earlier work of Italian engineers.

Leonardo had ample opportunity to examine the drawings of Mariano Taccola and Francesco di Giorgio of Siena, as well as the book of Roberto Valturio (1472). But for the most part, during Leonardo's professional career, technical knowledge was passed on through the guilds and apprenticeships, such as the studio of Verrocchio in which Leonardo was trained.

The codification of machine knowledge in 'theatre of machine' books, such as those of Francesco di Giorgio and Roberto Valturio in the 15th century enabled knowledge of machines to spread far beyond the confines of the secrets of the guild and workshop. Printing also spread classical knowledge of mathematics and physics as contained in the works of Hero, Archimedes, Euclid and Vitruvius to a much wider audience than that at the beginning of the 15th century.

In recent years a debate has arisen among historians of technology as to whether one can really learn the process of technological creation by studying textural and even visual pictures of machines and processes. In a web-based essay, the Princeton historian of science, Michael Mahoney (2004) makes the case that one needs to examine the historical artifacts of technology as well as primary texts to have some understanding of how actual machines were made, especially since many of the technical specialists were probably illiterate or at least had limited access to written material. Other historians such as Ferguson (1992) and Mauersberger (1994) have also made the case for the importance

of visual knowledge in developing technology. Mahoney adds another dimension in saying that tactile feel as well as visual images played a fundamental role in technology before the 20th century and the role of models, prototypes and full-scale artifacts played an essential element in machine thinking. In building machines, the tactile experience of friction between parts and the muscular feel of the compliance of materials to withstand forces and torques certainly helped builders to decide what combination of machine parts would work and what would not. There is evidence in Leonardo's Notebooks that he had close contact with such guild workers and had built models of machines himself. Unfortunately there are few working machine artifacts that have survived from the Renaissance even in museums and we are left with limited, textual and pictorial evidence of how these engineers thought. The role of model collections in machine evolution is discussed in Section II.13.

Four centuries later, the Industrial Age was in full swing, yet the guild or workshop was still the fountain of creativity in the art of creating machines. At the dawn of the 19th century there emerged the Polytechnique Institute, beginning in Paris and spreading into the Germanic states. These institutions began to codify and propagate technical knowledge in a way that would forever substantially change technology and engineering. During the Renaissance however, universities did not codify nor teach scientific and technical knowledge. Bologna, perhaps the oldest university, taught civil and canon law. Universities at Rome, Pisa, Florence and Siena, all founded around the 14th century, taught medicine, law, theology and the liberal arts, but not engineering. In several places in his Notebooks, Leonardo chides those who can quote old knowledge but cannot create something new; he mocks a university trained scholar who has not had the practical experience of working in a guild as did Leonardo who had to create new art, buildings and machines.

The Renaissance was also a time of questioning the authority of the Roman Church and its dogma. Though the revolt of Luther and the Reformation did not begin until 1517, debate and dissent in the Church was underway in the 15th century. Questioning the Church's view of the world and new approaches to acquiring knowledge outside the Churches purview created a sense of freedom for artists, scientists and engineers. For Leonardo and other engineers it was a time to learn from experience, to observe the world with one's own eyes and draw one's own conclusions about the physical world. Yes, Galileo [1564–1642] was censored for his scientific views, but this was because he had written them down. Engineers and machine builders did not have to write about new machines, they simply built them. The reality of new devices made it difficult to claim they violated canon law.

The other reality of the Renaissance era was the experience of explorers who began to navigate the globe. Dias [1445–1500], Columbus [1446–1506], Vasco da Gama [1469–1524], Balboa [1475–1518], and Magellan [1480–1521], opened up the seas of the Atlantic, Indian and Pacific Oceans and sea routes to India and the Americas. These men were of the same generation as Leonardo. Amerigo Vespucci came from Tuscany. They were helping to construct a new global trading economy, which a century later would create demand for new machines for production.

Who influenced Leonardo in his engineering works? His earliest biographer Giorgio Vasari [1511–1574] said that Leonardo studied arithmetic for only a few months and that he was an excellent geometrician. The modern text of Hart (1961) mentions a Florentine Academy started by a scholar named d'Abbaco who taught Leonardo the basics of mathematics. Florence was a student center with origins in the 14th century. The curriculum was based on the studies of the seven liberal arts. The first three, labeled *Trivium*, were grammar, rhetoric and logic. The second four called *Quadrivium*, consisted of geometry, arithmetic, music and astronomy. Most students finished the *Trivium*, while very few completed the *Quadrivium*. There is no evidence that Leonardo was enrolled as a student, especially since he was not fluent in Latin, although he tried during his life to learn the language. As an apprentice to an architect, he likely learned the principles of geometry and perspective, subjects that he wrote about often in his notebooks. He probably became skilled at drafting and the use of the compass and other drawing instruments.

In Milan, Leonardo became friends with the mathematician Fra Luca Pacioli [d. 1510] with whom he helped illustrate a book entitled, *De Divina Proportione*, a text about proportions (Figure II.6). He also knew Fazio Cardano [1445–1524], who studied mathematics and optics at the University of Pavia. It is ironic that although he had no formal education at the level of the *Trivium*, through his acquaintances and experience and a curiosity about the world around him he acquired much of the learning of the university *Quadrivium*.

Besides his pursuance of formal knowledge, Leonardo absorbed the practical knowledge of the guild craftsmen. He likely witnessed the public construction associated with the completion of Brunelleschi's great Dome for the cathedral of Florence. Filippo Brunelleschi [1377–1446] was known for his inventive construction machines and cranes. Although his work was finished a few years before Leonardo was born, the great lantern on top of the dome was constructed while Leonardo was a teenager and he likely saw these great

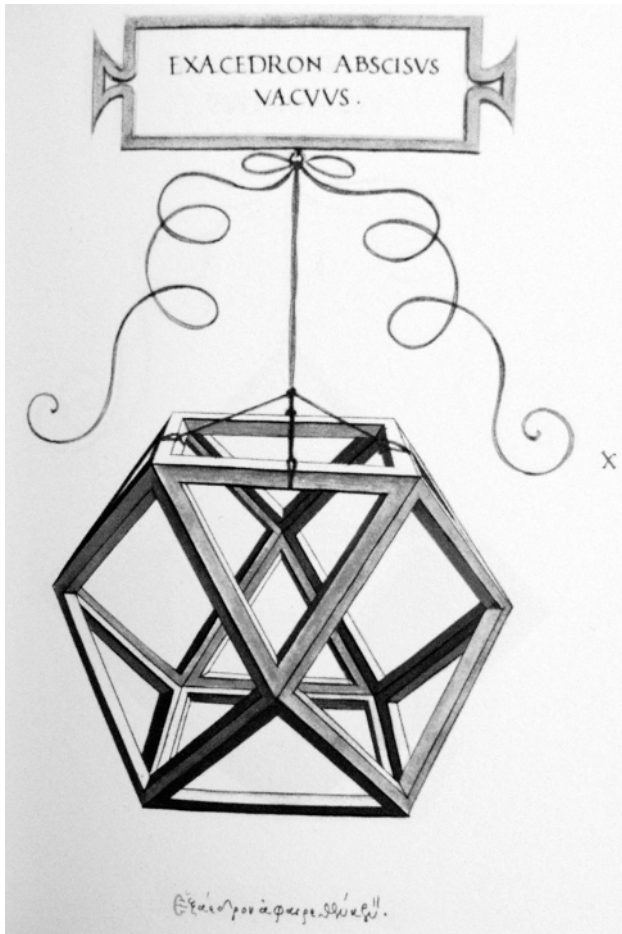

Figure II.6. Leonardo's drawing one of the Platonic solids for Fra Luca Pacioli's *De Divina Proportione* (1505). (Courtesy Cornell University Library)

machines and cranes attendant to the completion of the dome. His Notebooks show many designs for such construction machines and cranes.

The great architect Leon Battisti Alberti [1404–1472] also completed the facade of Santa Maria Novella in 1456 while Leonardo was a small boy. More important, Alberti, who was strongly influenced by classical architecture and the writings of Vitruvius, wrote a treatise '*On Art of Building*' shortly before his death that may have influenced Leonardo. In Leonardo's *Codex Madrid II*, is a list of books "*Record of books I have left locked in the chest*". In this list are two books of Alberti: *Batisti Alberti in architettura* and *Un libro da misura di Bta. Alberti* ('*On Architecture*' and '*A Book on Measurement*').

Bertrand Gille (1966), in a wonderful book on the Renaissance engineers, wrote that Leonardo had accompanied the older Sienese artist-engineer Francesco di Giorgio on a consulting job for the Duke Il Moro in 1490. Francesco had written a manuscript on machines and architecture that Leonardo had acquired for his library. There is also discussion of Leonardo's friends, acquaintances and contacts surrounding his career as an engineer and scientist in the book by Igor Hart (1961). From these and other references, it is clear that Leonardo's ideas about the nature of machines and engineering were not developed in a world devoid of technology. He was surrounded and mentored by creative and ingenious men, as he was himself clever and inventive. He was part of a continuum of machine evolution, a movement that accelerated during the 16th century.

Did Leonardo's technical drawings have any economic value or were they merely ingenious sketches of a professional artist? Leonardo's skills as an engineer were important in the 15th century because scientific knowledge and technology began to acquire strategic value to the politics and power of the state (see e.g. Daumas, 1962). Rulers hired military engineers, such as Francesco di Giorgio and Leonardo da Vinci as consultants. The merchant class of city-states wanted new manufacturing technology to compete in the growing global trade. A recent book by Masters (1999) presents evidence that Florence sought Leonardo's engineering advice to divert the Arno River; first to deny water to and defeat Pisa and second to obtain a navigable passage to the sea for trade. The competition among nations today for computer, biotech and aerospace technologies and the attendant trade and jobs they might bring is not new and can be traced to similar technology issues in the politics of Renaissance Europe.

THE ARTIST-ENGINEERS OF THE EARLY RENAISSANCE

The popular history of Renaissance technology often depicts Leonardo as the genius-inventor struggling against convention and tradition who brought forth new machines and technology. This view however is in conflict with academic literature that cites many other architects and artists who were also designing machines during the Renaissance (see Table II.4). The somewhat obscure published works of these artist-engineers mutes the theory that the technical work of Leonardo da Vinci was singular and unique. Two of the principle documents that support this evolution theory are the notebooks of Mariano Taccola and the books of Francesco di Giorgio Martini of Siena.

Mariano Taccola was born in Siena in 1381. Records show that he was a wood carver of church ornaments. He attained public position as secretary to

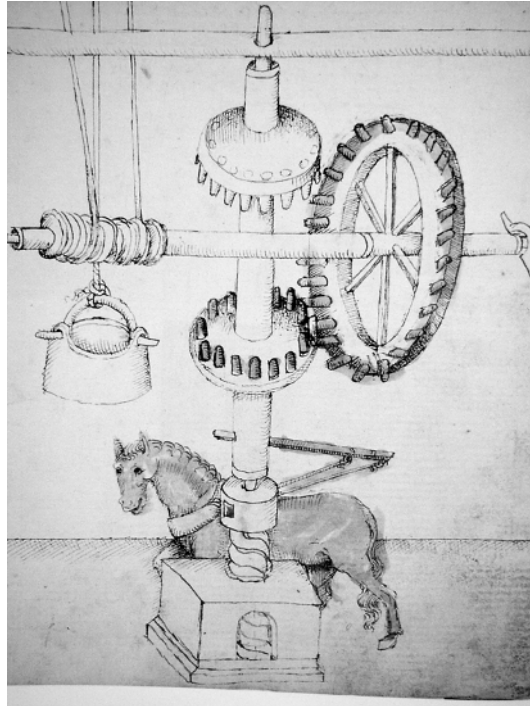

Figure II.7. Machine drawing hoist of Taccola (Mariano di Iacopo). (Cited by Galluzzi (1997) from Taccola Manuscript *Palantino* 766 (BNCF), Folio 10 *recto*)

a hospital and students' dormitory. There are records that Taccola presented his designs for machines to the visiting king of Hungary and German Emperor, Sigismund in 1432 (Knobloch, 1984). He wrote a number of tracts under such titles as *De Ingeis* and *De Machinis*, that later ended up at libraries in Munich, Milan and Florence. There is also evidence that he had met Brunelleschi. Like other so-called books of this time, his writings consisted of collections of pages with drawings, handwritten script, and drawings with script descriptions. The technical content dealt with military fortifications and war machines, water lifting machines, designs for mills and construction machines for lifting and moving large stone and other heavy objects (Figure II.7). Looking at these books, it is clear that a new field of machine engineering was emerging from the more mature fields of architecture, military and civil engineering.

The style of the machine drawings prior to the early 15th century was often flat and without perspective, in a manner similar to medieval painting. Also the drawings were not to scale. If one reconstructs some of these machines in modern isometric views, it is clear that many were precursors of

machines seen in the work of Leonardo and later machine book writers such as J. Besson (1578), Ramelli (1588), Strada (1617). There are designs for barge cranes, wheeled cart cranes, gear and pinions, cam driven hammers, piston pumps, log sawing machines and water mill machinery.

One of the great engineers of this period was Brunelleschi, who completed the dome of the cathedral of Florence. True to the practicing guild engineers of the time he was consumed with secrecy and did not leave manuscripts of his designs for machines. Other artists and architects of the time, such as Sangallo did record some of Brunelleschi's construction machines (see e.g. Galluzzi, 1997). In addition to Taccola, there is the work of Francesco di Giorgio [1439–1501] an older contemporary of Leonardo. Another artist-engineer, whose work has been labeled Anonymous Engineer or simply Anonymous is dated around the time of 1450. There is evidence that after the death of Taccola, di Giorgio had access to Taccola's machine books and directly copied and added his own designs and embellishments. There is also evidence in the *Codex Madrid* that Leonardo had a copy of at least one of Francesco di Giorgio's books and that one of the designs for a fortification was copied from this book. What is striking about the drawings of Taccola, Francesco and Leonardo is the emergence of perspective and isometric views of machines, especially in the work of Leonardo. His drawings look so much more real and natural that one can understand the conclusion of earlier readers of his work that he was the inventor of all these devices instead of a good chronicler of existing machines and machine designs to which he might have had access.

Besides Giuliano da Sangallo [1445–1516], there were several other important machine engineers who had written manuscripts that were copied and circulating during Leonardo's early years in Florence. One was the work of Konrad Kyeser [1393–c.1405], called *Bellifortis*. Another was Bonaccorso Ghiberti [1451–1516] whose book *Zibaldone*, dealing with war machines was well known at the time. Others include, Giacomina Fontana [1393–1455] and Roberto Valturio [d. 1484], whose work *De re militari*, was published in 1492 (see Part IV for a more detailed description of these machine books). Of course when we say 'published' the work was likely copied by official scribes for select wealthy persons and for the royal library. It is likely that Leonardo had access to the Medici library in Florence and certainly to the Duke's library in Milan. Leonardo also had his own library that contained copies of several of these early machine books. In Table II.4, there is a list of over two dozen machine books from the 13th to the 18th century. Many of these works are available in facsimile editions or can be found in digi-

tal format on the web (see e.g. the Cornell University website KMODDL; <http://kmoddl.library.cornell.edu>; click on references).

Two facts emerge from perusing these machine books over the period from 1450–1800. First, the idea of ownership of invention was not widely accepted and witness of an actual machine or a design for a machine made it public knowledge. Many machines were designed for construction and war or for mills to grind grains and it was very difficult to keep these designs secret. Second, there was a different standard for what we call ‘plagiarism’ perhaps following from the first observation. Whatever the social mores of the time, the evidence is convincing that machine topologies, materials, best practices and applications were passed down from one generation of machine builders and engineers to another in a way that crossed tribal and ethnic borders and languages, at least amongst the Asian, Arab and European peoples. As discussed in an earlier section, the Renaissance saw the maturing of a topological language of machines that was shared by many artist-engineers from the 15th to the 18th century; a vocabulary that gave them license to draw machines using ideas that were common within their profession.

II.8 FRANCESCO DI GIORGIO MARTINI: THE LEONARDO OF SIENA

In the Siena Pinacoteca Nazionale, there is a beautiful painting of a Madonna whose delicate features, style and technique reminds one of Botticelli in Florence. Casual visitors often overlook the painting because the painter is not as well known as his Florentine counterparts. This was also the fate of other Sienese artists as well as Sienese engineers. For example history of invention books feature the architect-engineers Brunelleschi and Leonardo but scarcely mention Taccola of Siena. Another forgotten Renaissance figure is the architect, painter, sculptor and engineer, Francesco di Giorgio Martini [1439–1501] born 13 years before Leonardo da Vinci. It is Francesco's Madonna (see Figure II.8) that is in the Siena Pinacoteca. Recently there has been greater recognition of his contribution to Renaissance architecture. Of importance to this book however, is Francesco's work as a machine inventor and designer. There is now growing acknowledgement that many of his machines were copied, though without attribution, in machine catalogs for over 200 years after his death by Zonca (1607), Strada (1617), Zeising (1613), Böckler (1661), Leupold (1724) (see Reti, 1963; Scaglia, 1992; Galluzzi, 1997). There is also evidence that many of his machine drawings were adapted from his predecessor Taccola [Mariano di Iacopo 1381–1458?], again illustrating the transmission of technical knowledge and design evolution through copying and imitation.

Francesco di Giorgio was born in Siena in 1439 with the baptized name, Francesco Maurizio di Giorgio Martino. There has been some dispute as to the year of his birth and we follow the citation of Allen S. Weller's 1943 biography (one of the few in English). Francesco was born to the son of a poultry dealer. Martino was his grandfather's name. Among historians there is also dispute as to his last name 'Martini'. Weller wrote that Francesco seldom used this name and in many texts Martini is dropped. There is little documentation of his early upbringing. Some believe, on the basis of style, that Francesco was apprenticed to the artist Vecchietta who also practiced painting, sculpture, military architecture and engineering.

Siena had its roots as a Etruscan town and later under the domain of Rome. Today it is part of Tuscany. Medieval walls surround the old city, and its 86-meter tower can be seen from outside the city. Siena is situated about 100 km south of Florence, it's rival from the 12th to the 17th centuries. Unlike Florence, with its access to the river Arno, Siena had a scarcity of water, but nonetheless built and cherished several large fountains. One of Francesco di



Figure II.8. Portrait of Madonna by Francesco di Giorgio Martini [1439–1501] in the Siena Pinacoteca Nazionale

Giorgio's engineering projects was to rebuild the aqueducts that feed these fountains, part of which still exist today.

Lorenzo di Pietro known as Vecchietta [1410–1480] is believed to have influenced Francesco di Giorgio Martini and may have been his teacher. His sculpture can be seen in the Merchant's Loggia in the statue of Saint Paul and an example of his painting can be found in the Town Hall or Palazzo Pubblico in the beautiful rendering of St. Catherine of Siena. Some of Francesco di Giorgio's paintings can be seen in the city art museum or Pinacoteca, including the Madonna described above. One of the unique art forms in Siena are the painted covers of the city's archive books, one of which was done by Francesco and depicts Siena and its recovery from an earthquake. Other masterpieces of Francesco are four bronze sculptures in the Siena Cathedral or Duomo.

Like Leonardo, who was born in Florence but worked for many years in Milan, Francesco di Giorgio spent many years outside of Siena working in Urbino in the Marches bordering the Adriatic Sea. In the service of Duke Federigo da Montefeltro, Francesco served as military engineer and architect, designing the city's fortifications. Unlike Leonardo, Francesco realized the building of many of his grand architectural designs. In his career, he designed and built 136 military fortresses and became a much sought after engineer. Many of these fortresses still exist and are among the most spectacular in

Italy, particularly those in San Leo and Sassocorvaro. He also designed and built a cathedral nearby the Ducal Palace in Urbino as well as the cathedral Santa Maria del Calcinaio, in Cortona in 1484.

In the Ducal Palace in Urbino, one can see today a frieze of 72 panels of carved stone commissioned by the Duke Federigo and designed in part by Francesco di Giorgio. Many of the panels represent machines and manufacturing processes such as mills, inspired by the drawings in Francesco's manuscripts (see Galluzzi, 1997, pp. 147–149).

There are four principal writings of Francesco di Giorgio, *Opusculum de architectura*, *Codicetto*, *Trattato I* and *Trattato II*. There is debate as to whether there are original manuscripts but there are many copies of these manuscripts. A checklist and history of the originals and copies is given in an extremely well documented book by Gustina Scaglia (1992), but we shall not pursue these details (see also the collection of essays, edited by Galluzzi, 1991).

Francesco's most famous manuscript was his *Trattato di Architettura*, arranged in seven books. The first six books are about architectural theory. Detailed descriptions of machines are contained in 'book seven' long forgotten and ignored until recently. There are several copies of this work, the most famous is in Florence at the Biblioteca Laurenziana (Il Codice Ashburnham 361) and believed to have been in the possession of Leonardo da Vinci. This version has 54 leaves and is believed to be the first version of *Trattato*. A larger version of 252 leaves is also in Florence at the National Library (Ms. II.I.141 (BNCF)). There are many copies of Francesco's *Trattato*, most of which do not contain all seven books and which contain different sets of machine drawings. One copy is in the Siena Biblioteca Comunale and another in the Biblioteca Ambrosiana in Milan. An example of the dissemination of technical knowledge in the Renaissance is the so-called *Anonymous Sienese Engineer* manuscript in the British museum (late 15th century) that contains copies of Francesco di Giorgio's machines as well as Taccola's drawings.

Two other works with machine drawings of Francesco are a small notebook of drawings in the Vatican called *Codicetto* and another, in the British Museum, dedicated to his patron Duke Federigo Montefeltro (80 leaves). Unlike Leonardo da Vinci, whose drawings lay hidden for many centuries, Francesco's work was copied early and had its influence on later machine inventors and designers.

The neglect of the engineering contributions of Francesco di Giorgio until recently can be seen in the seminal work by Singer et al. (1956) in which di Giorgio is only mentioned for his work as an architect and city planner. There

is only a token mention of Francesco di Giorgio in the biography of Leonardo da Vinci as an engineer by Ivor Hart (1961, p. 167). In contrast, scholarship on the machines of Leonardo da Vinci, began in the 19th century with the work of Grothe (1874) at Berlin, whose work may also have influenced Franz Reuleaux.

The historian Paolo Galluzzi (1991, 1997), of the University of Florence and the Istituto e Museo di Storia Della Scienza in two catalogs of exhibitions of the machines of the Renaissance, has discussed the roll of the Sienese engineers Taccola and Francesco di Giorgio on the work of Leonardo and others. He notes the centuries old tradition of copying the works of Taccola and Francesco di Giorgio's machine drawings without attribution. He also makes a point that the development of machine engineering in Italy was as attribute of the Renaissance period:

this complex of engineering pursuits is emerging ever more forcefully as a key aspect of Renaissance culture – an aspect that has not received proper attention from scholars of that period.

In order to evaluate the development of the technical achievements of the Renaissance, one must bring to the discussion technical knowledge of machines and kinematics as well as historical evidence.

MACHINE DRAWINGS AND KINEMATICS

Of interest to us is the range of basic mechanisms that are represented in Francesco's machine drawings and a comparison with the later work of Leonardo (Tables II.2 and II.3). Francesco's machine drawings are a marked improvement over the work of Taccola, which it is assumed di Giorgio Martini likely had access to. Following his architectural background, di Giorgio used the device of a frame structure to support the components of his machines. In contrast, Leonardo often drew machine elements without supporting structure. They simply float on the pages of his manuscripts. Francesco's frames provide a grounding link for his mechanisms. Also the frames were drawn in full perspective giving a three-dimensional feeling to the device that broke with the often flat drawings of the pre-Renaissance period. Francesco di Giorgio's drawings give one an idea of how to build these machines, although the component details are not as precise as those of Leonardo. Francesco also used shading inside these machine frames that enhanced the three-dimensional effect. Unlike later copyists such as Strada and Zonca, Francesco did not usually show humans operating these machines (Figure II.9). They stand by themselves as if they were moving autonomously.

Table II.2. Comparison of Francesco di Giorgio's and Reuleaux's basic machine elements

Reuleaux's 'Constructive Elements' in <i>Kinematics of Machinery</i> (1876)		Francesco di Giorgio Martini <i>Trattato di Architettura Cod.</i> <i>Ashburnham 361</i> , Florence, Facs.
Screws	Section 107	Folios 44r,v; 46v
Keys	Section 108	xxx
Rivets	Section 109	xxx
Bearings	Section 112	Folios 37r; 44r
Pins, Axles and Shafts	Section 110	Folios 46r; 41v: 45r
Couplings	Section 111	xxx
Ropes, Belts and Chains	Section 113	Folios 35r; 43v: 46r
Friction Wheels	Section 114	Folios 33v: 46r: 47r
Toothed Wheels	Section 115	Folios 33r,v; 41v; 44v
Flywheels	Section 116	Folios 33r; 37r
Levers, Connecting Rods	Section 117	Folios 36r, 43r
Click Wheels	Section 119	xxx
Ratchets	Section 121	Folio 43v
Brakes	Section 122	xxx
Engaging & Disengaging Gear	Section 123	xxx
Pipes	Section 125	Folios 26r,v; 41r
Pump Cylinders, Pistons	Section 125	Folios 36v; 41v; 43r
Valves	Section 126	Folios 41v; 42r; 43r
Springs	Section 127	xxx
Cranks and Rods	Section 117	Folios 23r; 42v: 43r
Cams	Section 145	Folios 35r; 42r,v; 43r
Pulleys	Section 158	Folios 42v; 51v; 52r; 53r

In some of the drawings, there is the suggestion of a landscape, or a ship, especially if the purpose of the machine related to water or the building of a canal, etc. Interspersed among the machines are beautiful and precise architectural drawings of fortifications and towers, palaces and cathedrals.

Another difference between the machine drawings of Francesco di Giorgio and Leonardo da Vinci is the applications represented in these designs. Clearly the machines of Francesco were designed for architectural, civil, military and engineering applications related to lifting, moving large materials and structures. There are also designs for processing food grains such as millwork, and there are pumps designed for water supply engineering in which di Giorgio was heavily involved. Leonardo on the other hand

Table II.3. Comparison of Francesco di Giorgio's and Reuleaux's basic kinematic chain mechanisms

Reuleaux's Basic Mechanisms § <i>Kinematics of Machinery</i> (1876) [Rx–Voigt Model Catalog Group]	Leonardo <i>Cod. Madrid</i>	Francesco di Giorgio Martini <i>Trattato di Architettura</i> <i>Cod. Ashburnham 361</i> , Florence
Linkages; revolute joints [Vgt-C]	§65–68, 74	✓ Folios 42v
Slider Crank Linkages [Vgt-C, D]	§69, 72, 74	✓ Folio 36v; 41v
Eccentric Linkages [Vgt-E]	§71	x xxx
Gear Trains [Vgt-G]	§104, 105	✓ Folios 44v; 46v
Cam Mechanisms [Vgt-L]	§145, 157	✓ Folio 43r
Pump, Blower Chains [Vgt-F.I]	§93–102	✓ Folios 36v; 42v
Screw Chains [Vgt-M]	§151	✓ Folios 44r,v
Ratchet Mechanisms [Vgt-N]	§119–121	✓ Folio 43v
Intermittent Mechanisms [Vgt-N]	§157	✓ xxx
Gear + Linkage Chains [Vgt-O]	§161	✓ xxx
Friction Wheel Chains [Vg-W]	§40	✓ Folios 40v; 47r
Universal Joint [Vgt-P]	§75	✓ xxx
Belt and Pulley Chains [Vgt-V]	§113, 158	✓ Folios 35,r; 46r
Straight-line Mechanisms [Vgt-S]		x xxx
Parallel Mechanisms [Vgt-T]		x xxx
Vane Control Linkages [Vgt-U]		x xxx
Escapements [Vgt-N, X]		✓ Folio 67 [Cod. Tor. Sal. 148]
Gear + Belt Chains [Vgt-Y]		✓ xxx
Clutch Mechanisms [Vgt-Z]		x xxx

had many machines related to manufacturing such as textile machines, metal forming and machining. Da Vinci also drew designs for clocks and measuring instruments, machines related to precision engineering or 'Feinmechanik' in German. Leonardo had his share of designs for war machines including trebuchets and cross bows. These differences probably reflect the economic activities of their respective cities and clients. Florence was a major wool and textile-manufacturing center. Siena was engaged in banking and selling of processed goods. This too was probably related to the energy resources of their cities; Florence had sufficient water for many mills, whereas in Siena water supplies were a constant concern for the Republic.

Leonardo liked to use the ratchet mechanism whereas Francesco uses it sparingly as in the hydraulic saw, although the ratchet details are not clear. Leonardo also drew detailed images of mating gear and pinion teeth whereas

di Giorgio uses mostly lantern pinions with round teeth. Euler in the 18th century determined that the ideal shape for gear teeth was either an epicycloid shape or an involute. Leonardo's designs seem to be more closer to this ideal than that of Francesco di Giorgio.

Another difference between Francesco di Giorgio and Leonardo as per machine design, is that the former drew complete machines whereas Leonardo has many designs of machine components, especially in the *Codex Madrid I*. Still one can see in Francesco's drawings, exercises in using combinations of machine elements to produce complete machines – such as steering devices for four-wheel carts. These machines were likely never built, but were drawn to illustrate the range of machine possibilities using several kinematic mechanisms. Today we call this *kinematic synthesis*; exploring the design space with a few basic machine elements.

Using Reuleaux's kinematic concepts for machines and mechanisms (Figures I.3 and I.14), we can classify the range of machine design capabilities that Francesco di Giorgio produced in his oeuvre. These ideas include basic kinematic pairs, closed kinematic chains or circuits, compound kinematic chains and constructive elements such as bearing supports and connectors such as rivets. (The bold italicized terms are Reuleaux's and the following elements are found in the drawings of Francesco di Giorgio.)

- ***Kinematic lower pairs***: Revolute or turning joints, sliding or prismatic joints, screws.
- ***Kinematic higher pairs***: Rolling elements, gear teeth, cams and ratchets.
- ***Closed kinematic circuits***: Gear pair and linked axes.
- ***Constructive elements***: Cables, ropes, bearings valves, flywheels, cranks, water wheels.
- ***Force-enhancing simple machines***: Screw, lever, winch, pulley, worm drive.
- ***Classic mechanisms***: Chain-of-pots water raising device, endless screw or worm drive, lazy tongs, wheel and axle, Scotch yoke.
- ***Dynamic machine systems***: Escapements, trebuchet, flywheels.
- ***Energy sources***: Animal, water, wind, human.

As has been pointed out by others such as Gille (1966), Francesco di Giorgio was influenced by the architectural treatise of the Roman engineer Vitruvius. He is credited with a translation of Vitruvius (Scaglia, 1985). His translation is considered important because he knew the technical terms of mechanics and construction that permitted a more comprehensive understanding of Vitruvius' work. Also Vitruvius influenced the machine drawings of Francesco di Giorgio. This is especially evident in the dual cylinder pump

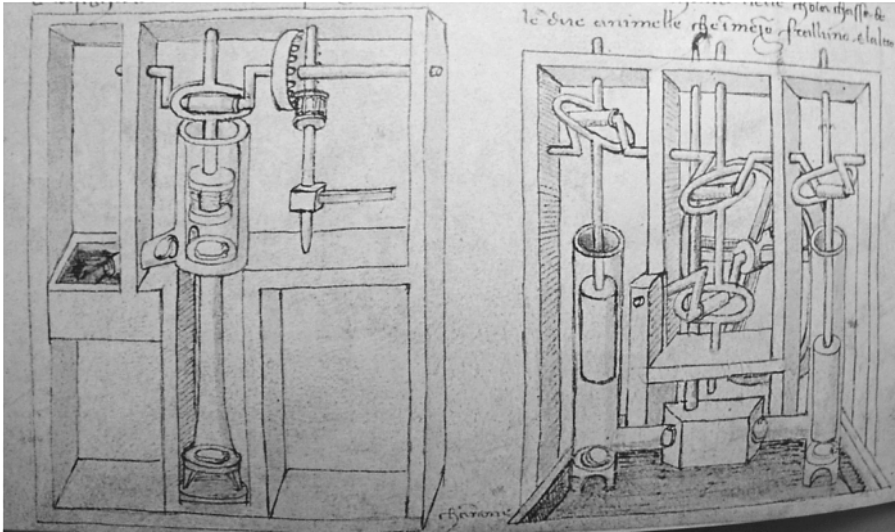

Figure II.9. Drawing of water pumps with valves by Francesco di Giorgio Martini (c. 1460)

of Ctesibius shown in Figure II.9 (right). Francesco was most ambitious in his designs for four-wheeled vehicles shown below in which he used several different mechanism concepts for steering mechanisms (Figure II.10).

In one design (left sketch, above) he used spiked wheels as the driving pair and two cranks to turn the steering axel in a prismatic slot. In another design on the same page (right sketch, above) Francesco used a curved rack and lantern pinion to turn the steering axel. Historians have speculated that these machines were probably designed to move large monuments or to move parts of stages for festival pageants.

COMPARISON OF FRANCESCO DI GIORGIO'S AND REULEAUX'S KINEMATICS

In an attempt to compare machine design in the Renaissance with that of the late 19th century 'Age of Machines', the Leonardo scholar Ladislao Reti compiled a table of machine elements ('constructive elements') of Franz Reuleaux and compared them with the drawings of Leonardo da Vinci. This table is reproduced in Table I.3. A similar table is presented here comparing this 19th century list with the drawings of Francesco di Giorgio (Table II.2). It is clear that of the 22 basic elements of Reuleaux, di Giorgio used 15 of them in his machine drawings in his *Trattato*. Most notable is his use of the crank in a positive return cam mechanism as well as his use of a rack and pinion

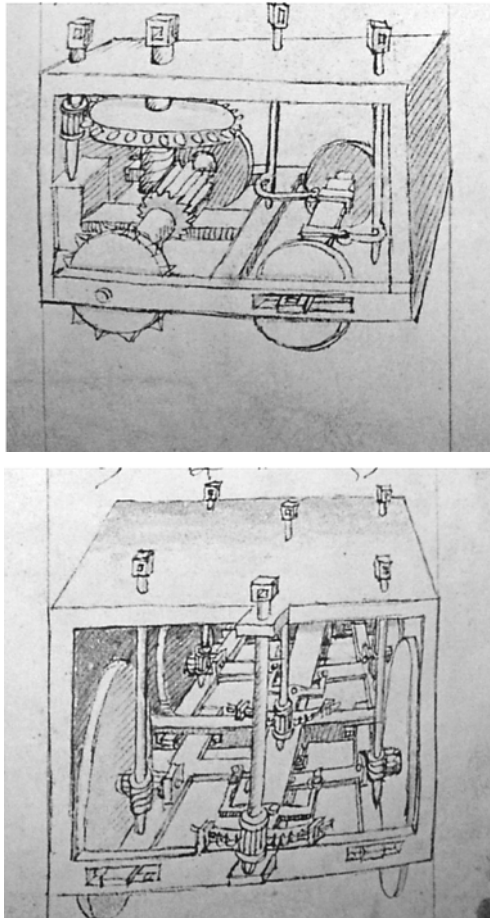

Figure II.10. Drawing of four-wheeled carts with steering mechanism by Francesco di Giorgio Martini

steering mechanism for wheeled carts. Gustina Scaglia (1992) in her extensive study of di Giorgio's manuscripts notes that Francesco's machines were often criticized as being too slow to operate because of his extensive use of worm drives and screws. It is likely that most of his designs were imaginative exercises rather than practical machines that were actually produced.

The use of machine elements such as screws, levers, gears, etc., does not show the range of kinematic mechanisms that were designed. To compare Francesco di Giorgio's machine drawings with 19th century machine design we create a list of kinematic chains in Table II.3, as found in Franz Reuleaux's *Kinematics of Machinery* (1876), as well as in the catalog of kinematic models produced by the Berlin model maker Gustav Voigt (Moon, 2003a). (See

the website <http://kmoddl.library.cornell.edu>, for images of the Reuleaux–Voigt models and a digitized copy of the Voigt catalog.) In Reuleaux’s classic book on the theory of machines (1876), he summarized six classes of kinematic chains in which most machines and mechanisms can fit (see Figure I.3a):

- **crank chain** (revolute and prismatic pairs); includes the four-bar and slider-crank linkages.
- **wheel chain**; includes gear trains, friction wheels.
- **screw chain**; including screw-nut fasteners.
- **cam chain**.
- **ratchet chain**; including escapements, and intermittent devices.
- **pulley chain**.

In Table II.3 we have added additional categories of mechanisms as found in the Reuleaux–Voigt models catalog labeled in groups A–Z. In comparing the 19 classes of kinematic chains and mechanisms of Reuleaux with machines of Francesco di Giorgio’s *Trattato*, one can see that di Giorgio used only about ten of these classes. In contrast Leonardo da Vinci used at least 14 of these kinematic chains in his *Codex Atlanticus* and *Codex Madrid*. Leonardo used many more ratchet chains as well as intermittent devices, gear and belt mechanisms and even a set of gimbals similar to the spherical linkage in the universal joint that is not found in Francesco di Giorgio’s work.

The greater variety of mechanisms used by Leonardo may reflect the variety of manufacturing that went on in Florence compared with Siena, such as textiles, clocks, and metal working. Although many of Francesco di Giorgio’s designs would have been limited by the friction in screw and worm drives, he does seem to have a roller bearing design for a thrust load in Codise Torinese Saluzziano 148 (Folio 52r), that appeared later in Leonardo’s *Codex Madrid I*, Folio 26r.

Several historians have noted that Leonardo had a copy of Francesco’s *Trattato* in his library of over 100 works. Notes in the margins of some of the pages of *Trattato I, Codice Ashburnam 361*, in Florence are believed to be that of Leonardo. Also Leonardo accompanied the older Francesco di Giorgio on a consulting mission to Pavia in June of 1490 to inspect a cathedral project (Weller, 1943). Thus there is a line of influence in machine design from Taccola to Francesco di Giorgio to Leonardo da Vinci. Reti (1963) has also drawn an influence chart documenting the influence of Francesco di Giorgio on the 17th and 18th century machine illustrators from Zonca (1607) to Böckler (1661) to Leupold (1724) and Borgnis (1818). This evolution of

mechanism and machine drawing from the Renaissance to the present is also discussed by Ceccarelli (1998) and Ceccarelli and Cigola (2001).

Reuleaux in his *Kinematics* (1876) cited the important work of both Borgnis and Leupold. “*Leupold (1724) seems to be the first writer who separated mechanisms from machines —*” wrote Reuleaux. “*One leading idea at least of Borgnis’ scheme has since become universally familiar; – his division of machinery into the parts receiving effort, the parts transmitting it and the working parts*”. Thus there may be a line of influence of ideas about the theory and design of machines from the Renaissance of Francesco di Giorgio Martini to the late 19th century ideas of Franz Reuleaux. This evolution of machine design follows recent theories of the evolution of technology as found in Bassala (1988) and other historians of technology. There is now beginning to emerge a solid trail of evidence and scholarly analysis that shows a continuity of tradition of kinematic machine design knowledge from the Italian Renaissance to the mid 20th century mechanism compendia such as those of Jones (1930–1951) and Artobolevsky (1975, 1979).

II.9 THEATRE OF MACHINES BOOKS: IMITATION OR INVENTION?

Contemporary historians of technology recognize that the development of machines was not the sole result of the inventor-geniuses but was part of human evolution of knowledge, especially craft and guild knowledge. These theories appeared a generation ago in several important books such as Bertrand Gille's *The Renaissance Engineers* (1966) and the five-volume work of Singer et al. *History of Technology* (1964). Evidence for this view of machine invention was always available in the published machine books of the 15th through 18th century, such as Francesco di Giorgio (c.1470-1480), Georgius Agricola (1556), Jacques Besson (1578), Agostino Ramelli (1588), Vittorio Zonca (1607), Salomon de Caus (1615), Georg A. Böckler (1661), and Jacob Leupold (1724), in a succession of books titled *Theatre of Machines* (see Table II.4, as well as Part IV). What is especially striking about these books, is not only the artistic quality of the engravings, but the fact that some of these artist-engineers blatantly copied from one another often without attribution. Were they guilty of plagiarism? Or were they simply recording such common knowledge that their similar representations of machines were merely symbols or icons of contemporary technology? To reinforce an earlier point, one can view these similar drawings part of a universal topological language of kinematic mechanisms.

The litany of 'theatre of machine; books cited above can also be found in the kinematics of machines books in the 19th century in the works of Lanz and Betancourt (1808), Robert Willis (1841) and Franz Reuleaux (1875–1876). This mantra by 19th C. authors shows the influence that the 'theatre of machines' books had on later machine designers and theorists. An important transition in these books occurred between the machine books of the 15th and 16th centuries. Several authors in the last century (e.g. Beck, 1899; Reti, 1963) have tried to make the case that the machine manuscripts of Leonardo da Vinci were the link between the early work of Kyeser, Taccola, Francesco di Giorgio, and Valturio in the 15th C. and Agricola, Biringucci, Besson and Ramelli in the 16th century (Table II.4).

We have already described the contributions of Aristotle and his school as well as Pappas, Hero and Archimedes. The book of Vitruvius in the first century BCE passed down through Arab copies and was later translated into Latin and European languages. There are no original drawings of the machines described in his work. Machine books with drawings begin to appear in the 13th and 14th centuries and continued into the 19th century. Many contained little in the way of description and theory but represent a series of

Table II.4. Theatre of machine books

Author	Publ. Date or Life Span	Short Title	City of Publ.
Ibn al-Razzaz al-Jazari	1204–1206	<i>The Book of Knowledge of Ingenious Mechanical Devices</i>	Mesopotamia
Villard de Honnecourt	c. 1225	<i>The Sketchbook of Villard de Honnecourt</i>	
Guido di Vigevano	1335	<i>Texaurus</i>	Pavia
Giacomo Fontana	1393–1455	<i>Bellicorum instrumentorum liber</i>	Venice
Konrad Kyser	1366–c. 1405	<i>Bellifortis</i>	Bavaria
Giuliano da Sangallo	1445–1516	<i>Opusculum</i>	Florence
Ghiberti Bonaccorso	1451–1516	<i>Zibaldone</i>	Florence
Marianus Jacobus/Taccola	c. 1450	<i>De Ingeneis</i>	Siena
Francesco di Giorgio	1470–1480	<i>Trattato di Architettura</i>	Siena
Roberto Valturio	1472	<i>De re militari</i>	Verona
Leonardo da Vinci	1480–1515	Notebooks [unpublished]	Florence, Milan
Vannuccio Biringucci	1540	<i>De la Pirotechnia</i>	Venice
Georgius Agricola	1556	<i>De Re Metallica</i>	Basel
Jacques Besson	1578	<i>Theatre des instruments mathematiques et mechaniques</i>	Lyon
Jean Errard	1584	<i>Le Premier Livre des Instruments Mathematiques Mechaniques</i>	Nancy
Agostino Ramelli	1588	<i>Livre des diverses et artificieuses machines</i>	Paris
Jacob de Strada	1617–1618	<i>Künstlicher Abriss allerand Wasser, Wind, Ross und Handt Mühlen</i>	Frankfurt
Heinrich Zeising	1613	<i>Theatri Machinarium</i>	Leipzig
Vittorio Zonca	1607	<i>Novo teatro di machine et edifici</i>	Padua
Salomon de Caus	1615	<i>Les Raisons des Forces Mouvantes avec diverses Machines</i>	Frankfurt
Georg Böckler	1661	<i>Theatrum machinarum novum</i>	Nürnberg
Otto von Guericke	1672	<i>Experimenta nova, ut vocantur Magdeburgica</i>	Amsterdam
Jacob Leupold	1724	<i>Theatrum machinarum generale</i>	Leipzig
Denis Diderot & Jean d'Alembert	1751–1772	<i>Encycopedie ou Dictionnaire raisonne des sciences, des arts et de metiers</i>	Paris
J.M. Lanz & Augustin Betancourt	1808	<i>Analytical Essay on the Construction of Machines</i>	Paris
J.-A. Borgnis	1818	<i>Traite Complet De Mecanique: Composition des Machines</i>	Paris
Ferdinand Redtenbacher	1857	<i>Die Bewegungs Mechanismen</i>	Mannheim
Franz Reuleaux	1861	<i>Der Constructeur</i>	Berlin

encyclopedic works that described classes of machines based on applications such as military machines, mining pumps, etc. These books are referenced in many works on the history of technology but rarely summarized as a group for comparison. A brief summary of most of these important works is listed in Table II.4. More detailed descriptions are given in Appendix I in Part IV of this book. Many original copies of these books such as Ramelli and Salomon de Caus have been digitized and may be found on the Cornell University website KMODDL under the 'References' section. Several others such as Besson can be found in the Dibner Library of the Smithsonian Institution website. The short monograph by Keller (1964) on the theatre of machines books highlights the work of Besson, Ramelli and Zonca. For those who can read German, the tome of Beck (1899) discusses the books of Frontinus, Biringuccio, Agricola, Besson, Ramelli, Zonca, Zeising, Fontana and Salomon de Caus as well as a detailed discussion of the machines of Leonardo da Vinci.

Valuable technical knowledge was preserved and transmitted to Western Europe by the Arab and Muslim Empire during the period 700–1400. One of these works is the 13th C. machine book of Al-Jazari. Around this same time appeared the small Sketchbook of Villard de Honnecourt (1225) that contains, artistic, architectural and engineering drawings. A century later a more extensive work of Guido da Vigevano (1335) appeared. By the beginning of the 15th century, the work of Vitruvius was translated into Latin and Italian, and though his chapters on machines did not contain drawings, many copyists added their conception what these machines would look like.

Thus before the time of Leonardo's notebooks (c. 1480–1515) there were many manuscripts in circulation relating to ancient, existing and new designs for machines as well as works by contemporaries. Some manuscripts have survived such as Konrad Kyeser (1405), Roberto Valturio (1472), Marianus Jacobus Taccola (c. 1450), Guiliano da San Gallo [1445–1516], Bonaccorso Ghiberti [1451–1516] and Francesco di Giorgio Martini [1439–1516].

It is natural to ask if Leonardo copied his machines and mechanisms from other machine books and manuscripts. There is evidence that he had access to the work of Konrad Kyeser and Roberto Valturio as well as the Sienese artist-engineer, Francesco di Giorgio. One of the books in Leonardo's library is believed to have been a book of drawings of Francesco di Giorgio similar in style to Leonardo's notebooks but presented in a more orderly format. In one example, shown in Figure II.10, we see a design for a wheeled cart with wheels with studs on the rim. Designs for steerable four-wheeled carts can also be found in Leonardo's *Codex Atlanticus* (Folio 579r/folio 216v.b; see Figure II.46).

In another drawing of Francesco di Giorgio, circa 1470–1480, we find a dual cylinder pump (Figure II.9). This pump was described by the Roman Vitruvius and attributed to the Greek engineer Ctesibius and also appeared in the work of an older contemporary of Francesco, Mariano Taccola. More than a century later in the machine book of Vittorio Zonca, *Novo Teatro di Machine et Edificii* (1607) we see a dual chamber pump activated on a rotating beam apparatus similar to what appeared in the steam engines of Newcomen and Watt in the 18th century. Clearly one can see an evolution from a twin lever action recorded by di Giorgio to single lever actuation in Zonca (Figure II.12b). In the machine book of Heinrich Zeising (1609 edition), one finds the exact same drawing of this pump as in Zonca except that the men moving the pumps have different costumes than in Zonca. This is pure copying with identical lettering on the parts.

VISUAL KNOWLEDGE VERSUS MATHEMATICAL ANALYSIS OF MACHINES

The historian Teun Koetsier (2000) of the Free University of Amsterdam has advanced a theory that the first important mathematical analyses of elementary machine systems in the Renaissance era appeared in the work of Guido Ubaldo del Monte [1545–1607] and Galileo Galilei [1564–1642]. Both works consider the force equilibrium of the so-called simple machines such as the lever, windlass, pulley, screw and inclined plane. Analysis of simple machines was a legacy of the Greek Alexandrian School and the School of Aristotle. Guido Ubaldo (1577) wrote his *Mechanicorum Liber* in Urbino and corresponded with Galileo. Galileo (c. 1600, 1960) wrote his *Le Meccaniche* at the University of Padua more than thirty years before his well-known work *Discourses on Two New Sciences* in 1634–1638. The latter work treats dynamics and strength of structural materials, both of which would become important to the design of machines in the 19th century. However neither Guido Ubaldo nor Galileo's works on simple machines are listed here in Table II.4 with the 'theatre of machines' books.

The machines presented in the 'theatre' books include complex machines with many kinematic and non-kinematic elements that defy a simple classification into, or deconstruction into, the ancient Greek lexicon of simple machines. The 'theatre of machines' authors as a group were content to visually represent the topological and geometrical aspects of the different machines and in some cases attempted to describe the relative motions of the parts of the machine. They rarely discuss the forces, torques and power necessary to make these machines work. The interest in forces and power of machines

came into play in the 18th and 19th century when the economics of running machines as well as the human liability related to machine failure became more important. Thus the work of Guido Ubaldo and Galileo in analyzing forces in machines does not have its impact until the 19th century.

Another engineer-historian, Marco Ceccarelli (2006) of the University of Cassino, Italy has advanced a similar theory as Koetsier but adds a further layer. He splits the Renaissance machine period into three phases; the first phase is the illustration of machines according to application such as in the work of Taccola, Valturio or Keyser (see Table II.4). The second phase is represented by the work of Francesco di Giorgio and Leonardo da Vinci who begin to visually explore the design space and in the case of Leonardo, begin to enumerate machine elements. The third stage of Ceccarelli's machine evolution is that of the development of a basis for teaching the mathematics of machines and this phase includes the above-mentioned work of Guido Ubaldo and Galileo.

The history of the principles of mechanics from Greek antiquity to the 19th century is discussed in the wonderful book of Rene Dugas (1955, 1988) *A History of Mechanics*. He makes links between Guido Ubaldo and Galileo in the 16th century and draws connections to Descarte, Newton, the Bernoulli's, Euler, D'Alembert, Lazare Carnot and Lagrange in the 18th century. Lagrange in fact cited the work of Guido Ubaldo, to close the circle. But the history of dynamics, forces and simple machines is well traveled and we shall not attempt to repeat this here. Instead our focus is on the visual and kinematic aspects of machine evolution and on two of the principal authors in the century after Leonardo, Besson and Ramelli.

BESSON AND RAMELLI

Two of the most influential machine books in the period after Leonardo's death were those of Jacques Besson and Agostino Ramelli. Both works exhibit beautiful machine lithographs in isometric views that provide much more detail than the sketches of machines in Leonardo's manuscripts. Each of the three authors have some machines in common that have led some to speculate as to whether these later engineers had access to Leonardo's manuscripts after his death in 1519 (Reti, 1972). In several examples of machines of both Ramelli and Besson, one can also find a similar machine in the work of Francesco di Giorgio whose books were widely circulated in the 16th century. It would be a mistake to attribute all the machine designs of the 16th century to 15th century artist-engineers as one can see by comparing the drawings. In Ramelli there is a greater variety of water pumping machines, a

greater use of linkages and gearing and the introduction for the first time of a rotary pump, a variation of which would become one of the sources for the Wankel rotary engine of today's Mazda sports car.

Jacques Besson [c. 1540–1573]

Jacques Besson was born in or near Genoble, France, lived for a time in Lausanne and Geneva Switzerland, returned to France and then fled to England in the wake of French persecution of French Protestants (see the Dibner Library, Smithsonian website article on Besson.) According to records, Besson worked as a water pump engineer, became a protestant minister, and then taught mathematics in Lyon and Orleans in the period 1564–1567. At this time he published a book *Le Cosmolabe*, in Paris 1567, which described an instrument for navigation, surveying and astronomy. Besson reportedly met French King Charles IX in Orleans at this time and described to him his inventions of new machines. Besson returned to Paris in 1569 with the King as 'master of the King's engines'. Besson published the first edition of his famous machine book in 1571–1572 with 60 engravings and brief descriptions of the machines. After his flight to England and his death in 1573, a second edition was published in Paris in 1578 under the title that we know today as *Theatre des instruments mathematique et mechaniques*. In this edition descriptions of the plates and machines were written by a Francois Beroalde de Verville.

Besson's book contains six plates of mathematical drawing instruments. The remaining plates present machines for sawing lumber, mills, pumps, lathes, and construction equipment. The drawings of some of the machines use a grid in the ground plane from which the reader could deduce the relative dimensions of the parts of the machine. In contrast to machine books of the 15th century, there are no war machines for siege and battle. The engravings for the second edition were taken from the 1571 book. The plates were made by a professional engraver in Paris. Unlike the manuscripts of Leonardo da Vinci, we do not have original drawings of Besson himself. So we do not know how skilled he was in drawing or how much detail was added by the engraver. Besson represented these machines as his inventions and obtained rights to these inventions from his patron, the King of France. But of course, many machines have antecedents in earlier machine books.

An example of machine copying in and from the work of Jacques Besson is a machine for cutting logs into lumber (Figure II.11a). As the saw blade is moved up and down, the machine advances the log into the path

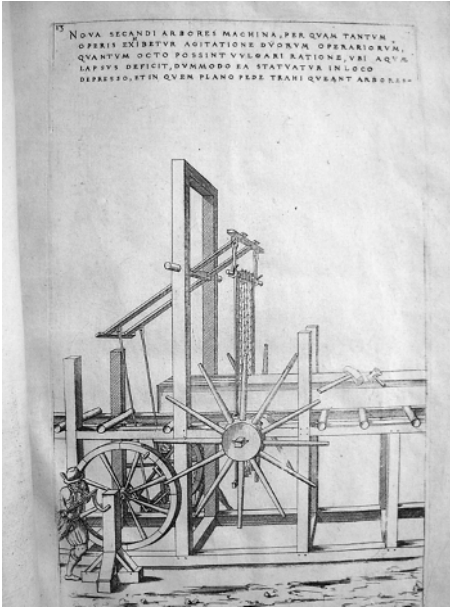

Figure II.11a. Design for a log-cutting machine by Besson (1578)

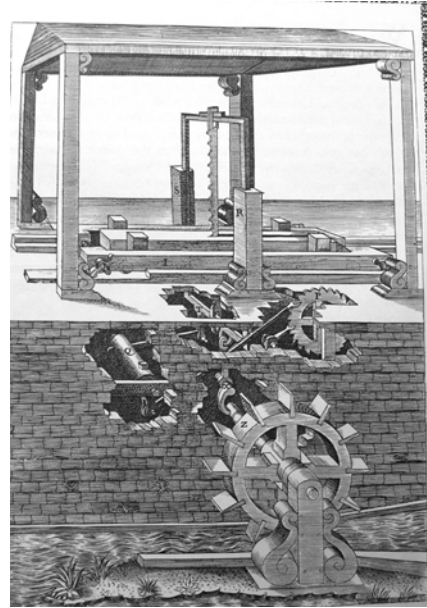

Figure II.11b. Design for a log-cutting machine by Ramelli (1588)

of the saw. This is a sophisticated design and clearly shows the early development of manufacturing automation. What is interesting is that a similar design originally appeared in the 13th century *Sketchbook* of Villard de Honnecourt and in the 15th century book of Francesco di Giorgio (see Figure II.5). A slightly different design appeared in Ramelli's 1588 book (see Figure II.11b). The log-cutting machine also showed up in the 16th century work of Salomon De Caus, *Les Raisons des Forces Mouvantes avec Diverses Machines* (1615), drawn with a different perspective. Copying of the same machine can be found in the work of Georg Andreas Böckler, *Theatrum Machinarum Novum* (1661) (Figure II.12a). Needless to say a version of the automatic log-cutting machine appeared in Leonardo's *Codex Atlanticus*, Folio 1078a-r (folio 389r,a). Thus the log-cutting machine had entered the lexicon of machine designers as an icon by perhaps the 14th–15th century. Many other examples can also be found in pumps, e.g. chain of pots, grain mills, and construction machines such as cranes.

Agostino Ramelli [c. 1531, c. 1600]

Ramelli was born in a small village northwest of Milan and was a military engineer for French kings. In addition, he is reported to have designed many

fortifications but he never finished a book on these designs. As a military engineer, one would assume he had practical experience with at least some of the machines he designed in his published book. Besson on the hand, born in France, was more or less a mathematician. His unpublished manuscript that preceded his published book contains so-called ‘principles’ for design of machines. One can assume that either many machines in his drawings were made from existing books or from his imagination.

Ramelli’s 1588 work *Livre des diverses et artificieuses machines* has been translated into English and reprinted by Dover Publications in 1994, edited by Gnudi and Ferguson. There is a wealth of scholarship in this edition, including an inventory of types of machines, and machine components in the near 200 plates. (This level of scholarship, combining a knowledge of Renaissance Italian and French as well as engineering expertise, has yet to be done on many of the Theatre of Machines books in Table II.4, and suggests a challenging task awaiting future scholars in the history of machines.)

Although Ramelli worked as a military engineer, more than half the plates in his book concern water-raising machines and only about two dozen plates deal with military machines. Some critics of this compendium of machines have suggested that many of the machines are too complicated and that the friction between gears and bearings would have made them impossible to work. Since it is likely that wood and iron would have been the materials used by 16th century craftspeople had they been made, it is unlikely that any would have survived to the present. It is also likely that some machines were drawn to represent contemporary machines while others were invented in the imagination of Ramelli. As with Francesco di Giorgio, we can view many of these drawings as an exploration of the design space, for instance, when he has three plates on toroidal water pumps.

In a detailed paper, written in 1972 after the discovery of Leonardo’s Madrid Codices in 1965, the Leonardo scholar Ladislao Reti published a detailed analysis of the machines of Ramelli and Leonardo da Vinci. He gave over ten examples of nearly similar machine or kinematic mechanism designs in Ramelli’s book and Leonardo’s manuscripts. Acknowledging the fact that Leonardo’s machines were similar or influenced by the earlier machine books of the 15th century, Reti nonetheless argued that Ramelli must have had some access to the Leonardo manuscripts after his death in 1519 or that knowledge of the work of Leonardo was so widespread that it became part of the common knowledge of the machine craftsmen of the time. Reti gave no specific instance in which Ramelli would have had access to either the owner of the manuscripts, Francesco Melzi, or to the manuscripts themselves.

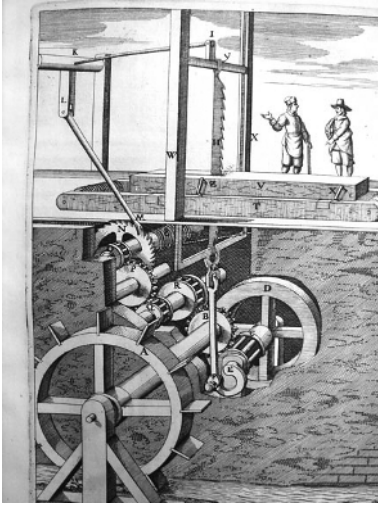

Figure II.12a. Log-cutting machine drawing of G.A. Böckler (1662)

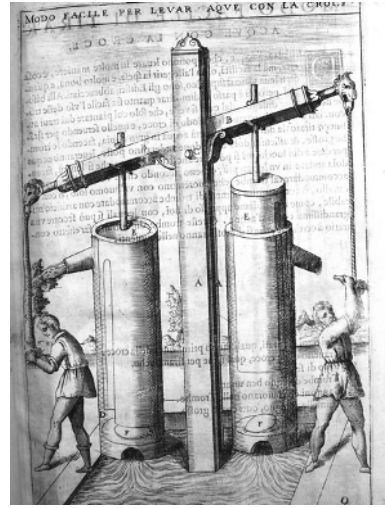

Figure II.12b. Double-piston pump drawing of Vittorio Zonca [1568–1602]

There are of course other explanations for the similarity of Leonardo's drawings and those of later engineer-artists. One is the fact that Leonardo had many associates and assistants some of whom traveled with him and after his death might have transmitted some of his machine designs either informally or more directly to other engineers. He likely knew or worked with a number of engineers in both Florence and Milan who may have known about some of Leonardo's designs. There were also anonymous collections of machine drawings that were published which included copied designs from many sources in the 15th century, and it is likely that some of Leonardo's designs were propagated in this manner. With Leonardo, as with most of the machine book creators, we are unlikely to find the key evidence as to how machine design knowledge was transmitted through the centuries. Typical of many elements in an evolutionary process 'all of the above' are likely explanations for the transmittal of engineering knowledge from the Renaissance to the Industrial Age.

Perusing the drawings in these books over several centuries, one can see a trend in the types of machines presented from those designed for siege warfare as in the works of Vigevano and Kyeser to machines designed for mining (Agricola), metals processing (Biringucci) to machines designed for manufacturing (Besson).

Examples of a few of the machine drawings from the 'theatre of machine' books of Zonca, Böckler and Leupold are illustrated in Figures II.12a,b and

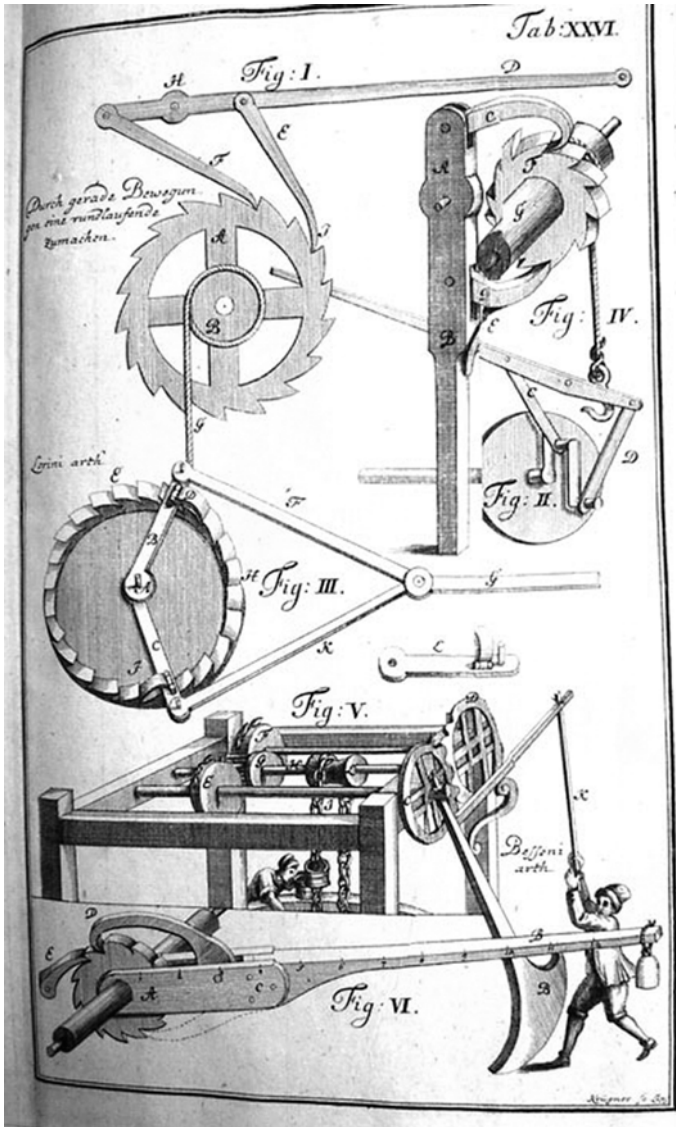

Figure II.13. Machine elements drawings (ratchets) of Jacob Leupold (1724)

II.13. George Böckler called himself an architect and engineer. The title of his book ‘Schauplatz’ or *Showplace of Mechanical Technology*, mimics Besson’s use of the phrase ‘theatre of machines’. Zonca called himself an architect of Padua, while Leupold referred to himself on the cover of his book as “*Mathe-matico und Mechanico*”. Thus these writers saw themselves as both machine professionals as well as scientists or mathematicians.

Copying of machine drawings continued into the 19th and 20th centuries. A machine theorist who influenced the work of Reuleaux was Robert Willis [1800–1875] of Cambridge University. Willis published a book on the kinematics of mechanisms in 1841 that influenced a French engineer C. Laboulaye who used exact copies of many of Willis' drawings in his own book. In the United States, a patent attorney named Henry T. Brown published a magazine called the *American Artisan* in which he featured different machine mechanisms. He collected these mechanisms in a small book called *Five Hundred and Seven Mechanical Movements* (1868) that advertised on the front page: “*Many movements never before published*”. Close to three dozen drawings of mechanisms were exact copies of figures out of Robert Willis' 1841 book with no attribution. Further, more than two dozen drawings and mechanisms in Brown were copied from an Italian work of Bognis published in 1818 (Figures II.14a,b). Later in 1943, William M. Clark, a mechanical hobbyist, constructed 160 models based on Brown's book and then republished Brown's catalog under the title *A Manual of Mechanical Movements* (1943), under his own name with Brown only mentioned in the Preface. Clark's models were exhibited in the Newark Museum in New Jersey for many years and a set of 120 Clark models are on view in the Boston Museum of Science today. (See these models as well as a digital copy of Brown's catalog at the website; <http://kmoddl.library.cornell.edu>.) It should be noted that Bognis' classification was inspired by an earlier table of mechanisms published by Lanz and Betancourt (1808) part of which is shown in Figure I.17.

The idea that the advance of technology stems mainly from the imagination of the human soul was perhaps a Victorian compromise with the conflict between the Newtonian, rational, mechanistic view of the world and the romantic idea that science could not explain human creativity and emotions. Many writers and intellectuals in the 19th century believed that whatever the latest ‘theory of everything’, the human soul, brain and spirit was still beyond the rule of science. It is no accident that in the late 19th century many writers canonized Leonardo da Vinci as the world's artistic and scientific genius when a number of his notebooks were translated and facsimile copies of his drawings were made public.

In the late 19th century, Franz Reuleaux edited a book of inventions that traced several technologies back to ancient times (*Das Buch der Erfindungen, Gewerbe und Industrien*, Band I–IX c. 1884). Perhaps inspired by Darwin's discoveries, Reuleaux believed that machine invention was part of the universal human desire to improve the quality of life and as in the development of language, the evolution of mechanisms had millions of inventors. One of

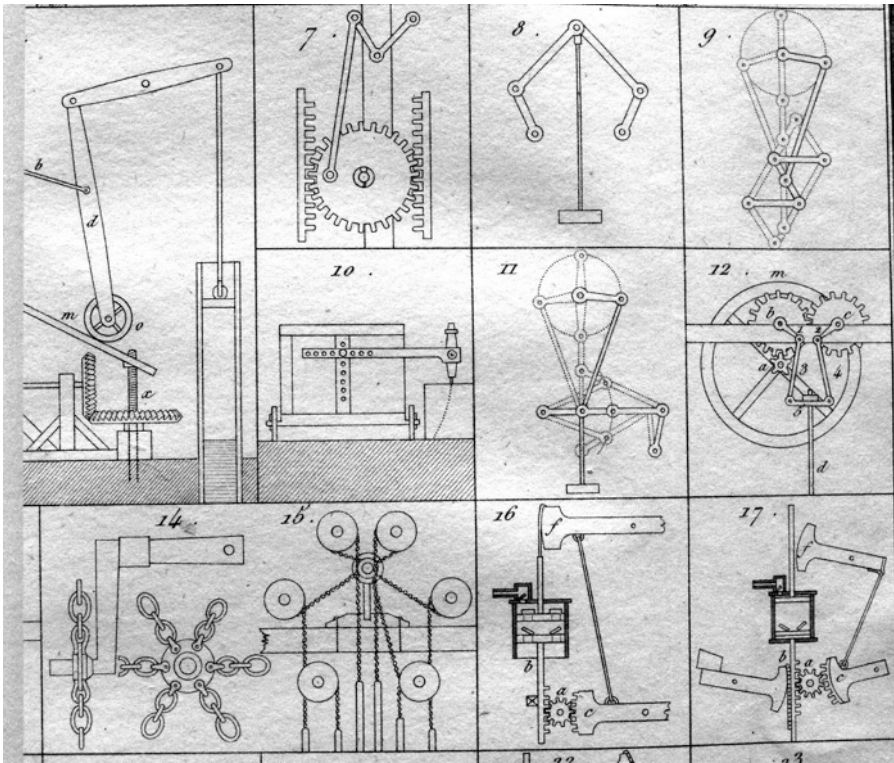

Figure II.14a. Mechanism classification table from Borgnis (1818)

Reuleaux's hobbies was the collection of ancient *spindle-whorls* for making thread (see e.g. Singer et al., 1954, Vol 1). A photograph of his study at home shows a number of these simple devices, used primarily by women, to spin wool and other fibers into yarn. Reuleaux often dismissed the theory that the first machines were related to the so-called simple machines. Early Greek science had enumerated five building blocks of machines, the so-called simple machines; lever, pulley, wheel, screw, and wedge or inclined plane. Reuleaux believed instead that the essence of machines was their ability to change motion. He posited the theory that mankind discovered the first rotary machines from the use of these early spindle-whorls as well as rotary fire making sticks. Oddly, one of the only technical items that appear in Leonardo's paintings is in one called the 'Yarnwinder', painted late in his life. In this 'Madonna and child' painting, the infant Jesus is shown holding and gazing at Mary's yarn spinning spools in the shape of a cross.

Some critics have noted the lack of evidence that Leonardo's machines were ever realized either as prototypes or in practice. Except for the architect

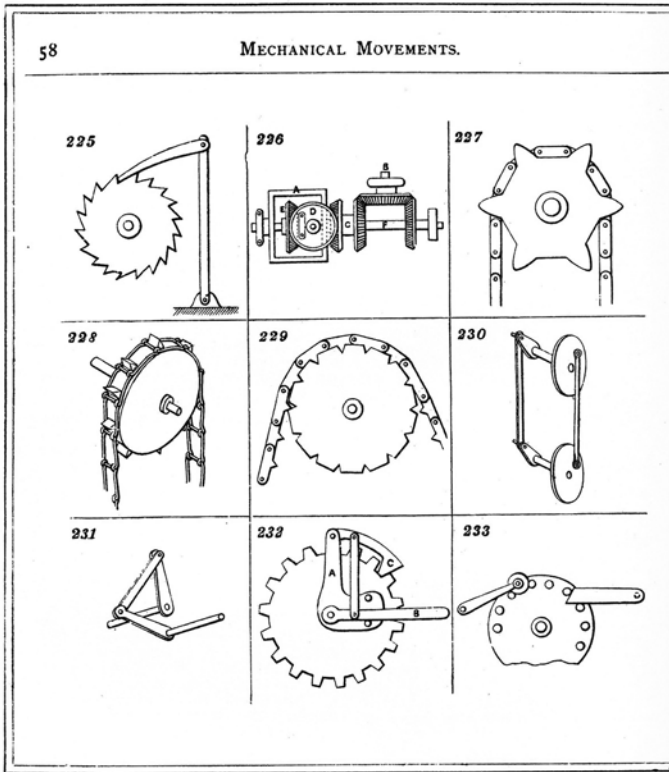

Figure II.14b. Drawings of mechanisms from catalog of Henry Brown (1868)

Brunelleschi, who had to construct machines to build a cathedral in Florence, few of the artist-engineers ever built any of the machines depicted in their encyclopedias. In fact this separation of design and manufacturing functions in engineering continues to this day. In the Middle Ages, Renaissance and post Renaissance, machines were built by guild mechanics who were not about to advertise the secrets of their trade. The engineer consultants however, wrote notebooks that described their knowledge in the art of machines often as a way of advertising their knowledge to prospective patrons. Some of these notebooks were widely published and others were kept in private until after the death of the engineer, as was the case of Leonardo. In the 19th century this division of labor took the form of the manufacturing workshop and polytechnic university. Reuleaux and others such as Rankine in England and Robert Thurston in the United States published books describing the construction of machines but were not themselves machine builders, except as consultants.

The old adage in academia, ‘*those that do, make things, and those that don’t, write books*’, may have also been voiced many centuries ago.

In summary, there was an encyclopedic tradition of over five centuries of free adaptation of machines and mechanisms by dozens of writers from many countries. Although Franz Reuleaux advanced machine design by bringing mathematical and scientific principles to the subject, his own design handbook, *The Constructor* (1854–1893), contained over 1200 figures and diagrams of machines mechanisms and machine parts. His personal notes and papers in the Deutsches Museum in Munich show that he collected many brochures and catalogs from different machine producers from around the world. Reuleaux tried to demonstrate, through his use of a special symbolic language for mechanisms, that many apparently different mechanisms, some of which had received patent protection, were derived from the same kinematic elements. Thanks to historical records, manuscripts and books, many of these elements can be traced to the early beginnings of technology. Like common words in several languages, these machine elements became part of the ‘lingua franca’ of machine builders throughout the last two millennia. In the same way, new words in our own language of machines have entered the global language of machines such as the electronic chip, hard drive, and hybrid engines. And the internet has become a modern medium for a new ‘theatre of machines’.

II.10 MATHEMATICS, MECHANICS AND DESIGN OF MACHINES

Much of technology had its roots in solving the problems of daily life, such as making textiles and clothing, constructing shelter or grinding grains for food. Out of these endeavors arose workshops, artisans and guilds for producing machines and processes. One of the great human achievements has been the codification of technical invention and development through the use of mathematics, scientific laws and professional standards. This codification freed the creation of machines from the secretive world of the workshop and allowed this knowledge to diffuse throughout the world.

The mathematical coding of machine design was well on its way during the career of Franz Reuleaux and his teaching and books helped accelerate this development that began in the late 18th century at the newly created Ecole Polytechnique. The Ecole was one of the positive achievements of the French Revolution amidst the chaos of The Terror.

Gaspard Monge [1746–1818], a notable mathematician, had a vision for a new curriculum for engineers that was based on a course in descriptive geometry. Up to this time advancement in machines had been recorded in so-called ‘theatre of machines’ books that were a historical catalog of engravings of past and present machines. The most famous of these before the Ecole revolution in engineering education was the works of Jacob Leupold (1724) who began to search for some kind of classification scheme for machines that departed from the traditional taxonomy based on application, e.g. mining, military, construction, pumping, manufacturing, etc. *Descriptive geometry* as advanced by Monge gave engineers mathematical tools to represent three-dimensional machines and their constituent parts as precise drawings in the plane of the paper by projecting the objects onto several planes. Drawings of parts with dimensions could be easily reproduced and distributed beyond the secret skills of craftsmen in the workshop. The other mathematical tool of significance, especially for machine design, was *analytical geometry* in which the paths of points generated by the motion of different links in a mechanism could be represented not only by geometric construction but also by algebraic formulas. The third mathematical tool was of course the *integral and differential calculus* that was taught to engineers at the Ecole and similar institutions but did not serve as a real practical skill as did descriptive geometry.

The mathematical subject of *ordinary and partial differential equations* is very important for the study of dynamics, as well as calculating the stresses in machines. Differential equations was an extension of the calculus of Leibniz [1646–1716] by the Bernoulli family (c. 1690) and was quite developed amongst mathematicians in the 18th and 19th centuries such as Euler and

Lagrange but was not used extensively in engineering practice until the early 20th century.

Two branches of mathematics that emerged from Reuleaux's kinematic theory of machines are topology and combinatorics that in machine design took the name *type synthesis*. More will be said later of these ideas. Reuleaux sought to find a so-called topological invariant in a mechanism by using the sequence of links and joints in a kinematic circuit. With this technique he reduced dozens of apparently different mechanisms to one kinematic symbol class. Kinematic combinatorics was developed by a German follower of Reuleaux named Martin Grübler who posed the question; given a set of M links and N joints of certain types how many ways is it possible to create a mechanism with 1, 2, or more degrees of freedom? These mathematical tools address the question of 'what is possible?' in a class of mechanisms. The emphasis is on synthesis not analysis. Reuleaux saw such tools as mathematical techniques for invention of new mechanisms and machines.

This discussion of mathematics and machines raises the question of what was the status of mathematics of machines in Leonardo's time? The calculus did not appear until the time of Newton and Leibniz at the end of the 17th century. During the 15th century there was a good understanding of number theory, algebra, trigonometry and geometry. Here we are lucky to have as documentation the thousands of pages in Leonardo's Notebooks. We also have copies of the Renaissance architecture-engineering books of Alberti, Taccola and Francesco di Giorgio though because of the more formal nature of these books, they do not always show the thinking processes of these architect-engineers that are more evident in the more personal notes of Leonardo.

The mathematical analysis of machines can be traced to the Greek books of Archimedes and Hero. Some scholars have argued that the rediscovery of these texts in the early 15th century helped advance the evolution of machines in the late 15th and 16th centuries. Certainly Leonardo often referenced Archimedes in his Notebooks. In *Manuscript G*, Folio 96r he wrote:

[finding the square of the circle] – was first discovered by Archimedes the Syacusan who found that the multiplication of half the diameter of the circle by half of its circumference made a rectangle equal to the circle. (MacCurdy, 1906)

In modern terms this leads to Pi multiplied by the square of the radius, which equals the area of the circle.

On the back of this same folio (*Manuscript G* Folio 96 verso) Leonardo wrote of his faith in mathematics:

There is no certainty where one can neither apply any of the mathematical sciences nor any of those which are based upon the mathematical sciences.

Archimedes wrote on the principle of the lever and the pulley and Leonardo also pursued with much interest the balance of forces in levered and pulley systems. Archimedes also found relationships between the volume of solids and their projected areas and heights that was another topic of the Notebooks. The idea of the center of gravity is another subject in the mathematics of mechanics that Leonardo studied, perhaps inspired by the books of Archimedes.

The *Codex Madrid* of Leonardo was not available to MacCurdy when he summarized the contents of the other codices around the beginning of the 20th century. In *Codex Madrid* there are many folios with mathematical discussion and notes, often alongside engineering drawings of machines and civil and military projects.

One example that shows Leonardo's geometry based thinking, in a way similar to the use of descriptive geometry in the Ecole Polytechnique three centuries later, is his proof for the volume of a special tetrahedron. Consider a solid with four planar sides with a volume equal to one sixth of a cube, of which the solid forms one corner (Figure II.15). In *Codex Madrid II* (Folio 70r), Leonardo gives a proof by construction showing that he can find six different tetrahedrons in the cube. There is no algebra here, only geometric drawings. It illustrates that Leonardo's understanding of geometry went hand in hand with his drawing and artistic skills, a principle that was taught in engineering schools from the early 19th century until the late 20th century when computer software replaced drawing skills among engineers. In a mid 20th century book, Hilbert and Cohn-Vossen (1983) describe two tendencies in mathematics, *abstraction* and *intuitive understanding*: "*it is true today as it ever was that intuitive understanding plays a major role in geometry*". This thesis is also the premise of Cornell University mathematician David Henderson in his modern textbooks on geometry (Henderson and Taimina, 2004). Although Leonardo da Vinci did not use equations in many of his geometrical writings his method of proof by construction follows the '*intuitive*' method in mathematics.

In another folio in *Codex Madrid II* he wrote: "*The quadrature of every pyramid is at the third of its height multiplied by the entire surface of the base*" (Reti, translation). There are many folios devoted to 'quadrature' of areas and solids, i.e. finding relationships for areas and volumes. In some sense Leonardo's work anticipated the definite integral calculus one of whose principal uses is to calculate areas and volumes.

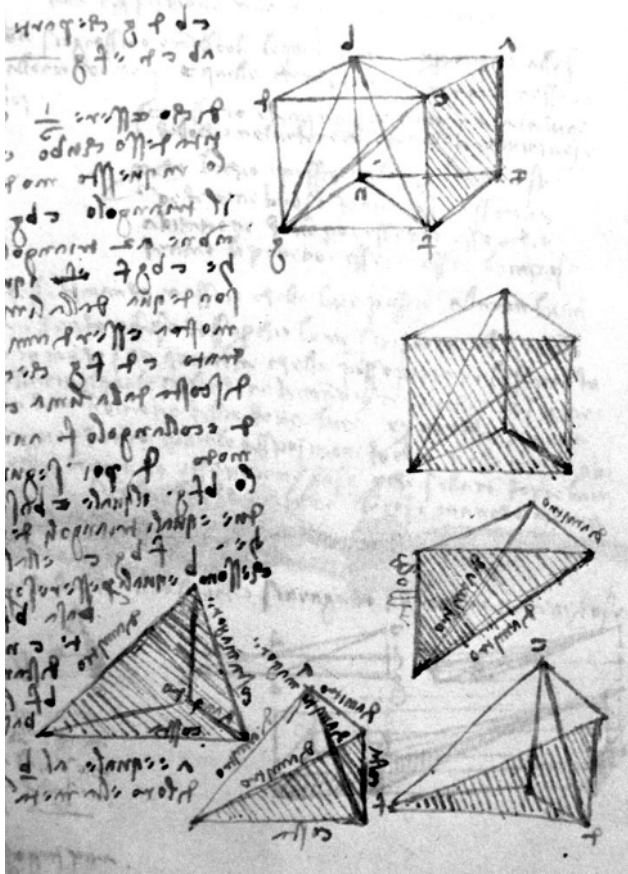

Figure II.15. Leonardo's quadrature of the cube using 6 tetrahedra. (*Codex Madrid II*: Folio 70r)

The use of descriptive geometry that originated in Monge's Ecole Polytechnique for the practical mathematical education of engineers and scientists persisted into the early 20th century. For example there is a beautiful book by Fredrick N. Willson, described as Professor of Descriptive Geometry, Stereotomy and Technical Drawing at Princeton University, entitled *Theoretical and Practical Graphics* (1898), subtitled *Descriptive Geometry and Mechanical Drawing*. What is interesting about this book is that it contains both geometric drawings of three-dimensional objects of the type one finds in Leonardo's Notebooks as well as drawing methods to represent abstract curves of kinematic motions of linkages (e.g. pp. 52–53) that are found in Franz Reuleaux's *Kinematics of Machinery* (1876). Notably Willson references the French works of Monge and Hachette as well as the German kine-

matics books of Reuleaux and Burmester. Willson is also listed as a member of the American Mathematical Society, the American Society of Mechanical Engineers as well as a Fellow of American Association for the Advancement of Science. The point here is the close connection between art, drawing, mathematics and machine design that developed in Leonardo's time and continued to mature into the last century. These geometric engineering skills evolved over a period of nearly half a millennium (1450–1950) but have almost disappeared in engineering education in the last two decades as computer aided design (CAD) software has replaced technical drawing skills. There are both mathematicians and engineers who believe the loss of the connection between mathematics and drawing is not good for either mathematics or design. The late historian of technology, Eugene Ferguson, in a 1992 book, *Engineering the Mind's Eye*, has also made this point.

The interest of Leonardo in quadrature of solids in *Codex Madrid II* is often presented in the context of architectural or civil engineering design such as drawings for a fortress reinforcement. In such problems it is natural to want to know the volume of earth or the volume of stones that would have to be hauled in or out of a work site and the calculation of geometric volumes would be very useful here. In contrast, in *Codex Madrid I*, which has many more machine drawings than *Codex Madrid II*, much of the mathematics discussion is either about center of gravity calculations or balance of forces as in lever and pulley systems. For example, in Folio 71v, Leonardo wrote about a drawing of a weighted rectangle with a cable attached:

I wish to lift heavy body ahKn by attaching a rope on a corner and pulling it along —. And I wish to establish a general rule for knowing which rope will be loaded by more weight and which by less.

Seeking a general rule for a problem is one of the hallmarks of the profession of engineering as contrasted with the artisan or craftsman who might encode his or her 'general rule' in the form of intuition. This illustration of Leonardo's use of mathematics differentiates him from earlier engineers such as Taccola or Francesco di Giorgio who may have been schooled in mathematics but did not give evidence of a drive to seek general rules for design.

The Russian historian V.P. Zubov (1968) in his recently translated book, devoted an entire chapter to Leonardo's 'mathematical sciences'. Zubov pointed out that for Leonardo and other renaissance mathematicians such as Luca Pacioli, mathematics and mechanics or physics were synonymous. When one thought about a mathematical question, it would often be framed by analogy to a mechanical problem or one in optics or astronomy. Zubov contrasted Leonardo's reliance on geometric construction and drawing with

the absence of visual tools by J.L. Lagrange (1788), who developed powerful mathematical techniques to solve problems in dynamical physics.

There are no drawings whatsoever in this book. The methods I expound here do not require either construction or geometric or mechanical discussions: they require only algebraic operations – (*Mecanique analytique*, 1788)

Nineteenth century mathematics ushered in a new era of mathematical analysis for science and technology that would eventually replace the use of geometric sketching and precise drawing with the calculus and differential equations. However geometric methods remained important to the kinematics theory of Reuleaux, Kennedy, Burmester and other pioneers of late 19th century of machines.

The art historian Kenneth Clark also made a connection between Leonardo's use of mathematics and perspective in art:

the study of perspective involved a real mastery of mathematics: and this the great artists of the quattrocento, Brunelleschi, – had evidently possessed. (Clark 1959, p. 126)

Leonardo sought to represent the truth in his painting as he saw it, not only in the use of perspective, but also in human proportions and the density of shadows and reflections of light from surfaces. He believed in the power of mathematics to reveal techniques to help the painter achieve this truth.

The use of geometric construction for mathematical proof led Leonardo to invent several drawing instruments as mathematical analog computers such as a proportional drawing compass, and an instrument to draw ellipses and parabolas. This tradition of using mechanisms, as analog mathematical computing devices, blossomed with James Watt's invention of a mechanism to trace an approximate straight-line motion. By the middle of the 19th century many mathematicians were inventing linkages to produce mathematical curves both for practical application in machines and as theoretical demonstrations of the power of mechanisms to create arbitrary mathematical curves. One important mathematical question of the times was whether it was possible for a set of links and joints to trace the motion of an exact straight line. The great mathematician Chebyshev was thought to have spent several decades in a proof that it was impossible until a French engineer named Peaucellier (c. 1864) and later Chebyshev's own student Lipkin (c. 1871), independently showed that a planar mechanism of eight links and ten joints could produce not only an exact straight line but also an exact arc of a circle of any radius (see Figure I.33).

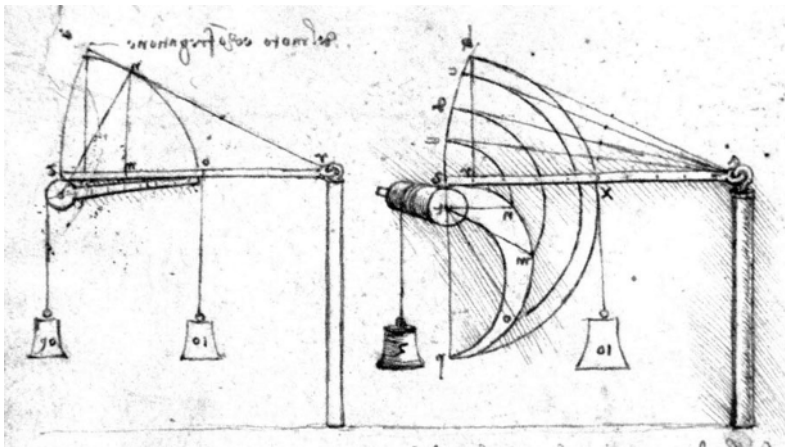

Figure II.16. Path points of moving links; drawing of Leonardo da Vinci (*Codex Madrid I*, Folio 63v)

With the development of descriptive geometry in the Age of Machines, kinematicians such as Robert Willis [1800–1875] of Cambridge began to use geometric construction to visualize the unseen motions of machine elements in mechanisms as they performed their cycles of motion as for example the epi-cyclic and epi-trochoid curves generated by a circle rotating on another circle. Reuleaux and Burmester used these so-called ‘roulettes’ as tools of kinematic synthesis (Figure I.26). Mathematicians in the 18th century such as Leonhard Euler had also used these ideas to discuss the shape of gear teeth. The use of tracer curves or ‘roulettes’ came into practical engineering use in the mid to late 19th century.

Leonardo used the concept of path points to represent the flow of water and air, extensively. He even described how to do experiments to visualize otherwise unseen fluid flows.

If you wish to see where water flows more rapidly – pour some water colored with sinopia together with oil into a stream which is flowing along an uneven bed. (*Codex Atlanticus*, Folio 720r: folio 266v, old)

He also suggested throwing dust in the air to visualize air currents. His drawings of fluid turbulence exhibit many characteristics of fluid flow that are today only revealed by computer simulation.

One does not find many drawings with path points of motions of machines in the drawings of Leonardo da Vinci. Two exceptions are in *Codex Madrid I* (Folio 3V and Folio 63v) which show the circular paths of one gear tooth or cam link moving another levered link (Figure II.16).

The representation of moving machine elements using paths of points in the drawings of 19th century kinematics engineers, distinguishes them from their counterparts in the Renaissance. The idea of *velocity* as the tangent vector to these point paths did not mature until the early 19th century. Beginning in the 18th century and developing into the 19th century, the machine was seen not as a static assembly of machine components, as one might find in one of Leonardo's beautiful exploded views, but as a dynamic collection of parts, each generating a field of complex tracks of motion in space. Use of dynamic information to design new mechanisms and machines began with ideas for clocks in the 17th century, e.g. Huygens (1673) but did not mature until the late 19th and early 20th centuries, especially in the books of Den Hartog and Timoshenko. Franz Reuleaux himself did not fully appreciate the dynamic nature of machine design and in this sense his theory of machines was closer to Leonardo's and the Renaissance engineers than to modern late 20th and 21st century machine theorists.

LEONARDO'S MECHANICS

"Mechanics is the paradise of the mathematical sciences" is the famous quote of Leonardo da Vinci on a subject that he devoted hundreds of pages to in his manuscripts. The study of the interaction of natural and actuated forces on material bodies and their effect on the internal stresses and motion of these bodies is the province of the scientific field of theoretical mechanics. Except for the so-called 'simple machines' of the ancient Greeks, the study of mechanics had not encompassed the study of complex machines until the 19th century. (The books of Guido Ubaldo (1577) and Galileo (c. 1600) in the post Renaissance era were exceptions in trying to extend mechanics analysis to machines.) Though Leonardo could speculate on the weight of a body and the time to free fall under gravity, he did not apply principles of mechanics to determine the torque required to turn the crank on a complex textile machine or water pump, though he did consider friction in machines.

Mechanics has many subfields, mechanics of particles and rigid bodies, fluid mechanics and mechanics of elastic solids. These problems are often divided into dynamic and static. Leonardo's curiosity had addressed almost all of these subjects, though not always with great precision and accuracy. In the field of statics he had examined the balance of forces and struggled with the concept of a force-moment. He also studied the mechanics of materials in the problem of friction between bodies and the bending of beams. A subject that occupies a great deal of space in his manuscripts is the center of gravity of material bodies. He also tried to define the concept of force and its effect

on the dynamics of particles. Another area of extended interest is his study of hydrodynamics, motivated perhaps by his work as a royal engineer in charge of canals and waterways. In his studies of machines, Leonardo seems to have limited his work to the applications of geometry and elementary kinematics of machines.

Several important studies of Leonardo's writings on mechanics have been made in the last century, such as by Pierre Duhem (1906), Ivor Hart (1925, 1961) and the famed 'father of modern continuum mechanics', Clifford Truesdell (1968). Many scholars of da Vinci have found in his writings statements that seem to anticipate the later work of Galileo and Newton, such as the quote: "*Nothing whatsoever can be moved by itself, but its motion is effected through another. This other is the force*" (MS A 21 v). Or "*An object offers as much resistance to the air as the air to the object*" (*Codex Atlanticus*).

Truesdell points out that there are many other statements that suggest complete misunderstanding of the nature of forces: for example, Leonardo wrote that there are four powers of nature, weight, force, percussion and movement; and that percussion is produced by force, force produced by weight and weight produced by movement. Or in another statement that movement has three forms, natural, accidental and participating. In reading Leonardo's manuscripts however, one has to appreciate that concepts of velocity, acceleration, vectors were still to evolve in later centuries, although there were earlier philosophical studies on science and mathematics by the Schoolman of the 14th century such as Albert of Saxony, [c. 1316–1390] and Nicole Oresme [d. 1382], works of whom Leonardo may have had access to. It would take another two to three centuries of work by Galileo, Newton, the family of Bernoullis and a host of other scientists and mathematicians to unravel the mathematical constructs of modern physics and mechanics.

One of the few principles of mechanics that Leonardo stated and has stood the test of time is his laws of friction; (i) the friction force is proportional to the weight or normal force between the bodies, (ii) the friction force is independent of the contact area and (iii) the ratio of the friction force to the weight is one quarter, a value that is close to that of many solid materials in contact. Truesdell (1968) speculated that the specific number of 'one quarter', suggests that Leonardo must have actually made experiments involving numerical measurements.

As for mechanics of machines, we find many examples of his analysis of the so-called simple machines of Aristotle's Peripatetic School; the lever, pulley, inclined plane, wedge and the wheel. Leonardo has many figures in his

manuscripts struggling with the balance of forces in levers, pulleys, weights supporting bodies on inclined planes, etc. These devices were of interest to Archimedes and other early engineers, because the source of power was human and the lever and pulley allowed humans to trade motion for smaller forces that humans could produce. In the Renaissance, water and wind power were available and the focus of machine design was on conversion of motion from one form to another to accomplish a desired task. For modern machine designers, the science base goes far beyond the equilibrium of forces in simple machines and embraces kinematics, thermodynamics, dynamics, materials science, control theory and artificial intelligence. Leonardo's study of complex machines can certainly be said to have involved ideas of kinematics and geometry and, in a few cases, ideas of automated regulation. In some examples he was aware of friction, wear and fracture of the materials in the machine. For the most part, he assumed that the machine would be made of the materials available to the workshops of his day.

Some scholars have tried to attribute to da Vinci a grand scheme to his studies of science and, in particular, mechanics. But he was more often an observer of the particular case, more accurate in his drawings than in his words. To quote Truesdell on Leonardo:

Where his words failed, his eye and hand recorded with passionate exactness, so that through his drawings, rather than the words of Leonardo, we learn of mechanisms and nature.

On the other hand, Truesdell and Hart, and other authors summarizing the accomplishments of Leonardo da Vinci, seem to denigrate his work on machines, to discount its importance in relation to the science of mechanics. Truesdell, for example, states that Leonardo's experimental knowledge was the common property of artisans and practitioners of the '*mechanic arts*'. Hart titles one of his chapters 'Leonardo the Engineer and Master of *Gadgetry*'. Many writers are quick to anoint Leonardo as an inventor rather than as an engineer, akin with an artist who creates something out of nothing. This ranking of the engineer below the mathematician and the scientist is a particular American prejudice, especially after WWII. In Germany, for example, especially in the works of Grothe (1874) and Beck (1899) we see an appreciation for the engineering contributions of Leonardo to the study of machines as a science. This is also appreciated by modern writers, such as Reti (1974) and more recently Galluzzi (1997).

Finally, one can ask whether Leonardo was motivated in his study of mechanics because of its application to design of machines and civil and military engineering or for its important to science. The author's belief is he was

largely inspired by the intellectual merit of the mechanics questions themselves, questions that had occupied the ancients and would continue to remain misunderstood for another two or three centuries. Leonardo did not study anatomy to cure sick people and it is unlikely he studied mechanics to build machines. Unlike his contemporary, Francesco di Giorgio Martini, who was a doer, one who painted, sculpted, and built dozens of castles and forts, Leonardo da Vinci was an immensely curious man with a wide range of interests rather than one whose mission was to solve particular problems or construct a theory of everything. As Vasari his biographer wrote, Leonardo's curiosity often diverted him from accomplishing many of the projects that he started.

THE MECHANICS OF SIMPLE MACHINES

The history of machines has several themes of which we present only one or two in this book. One theme is the popular history of specific machines and biographies of their inventors, as in the books of Eco and Zorzoli (1963), Strandh (1979) and recently Taddei et al. (2006). Another theme is the evolution of machine design with a focus on kinematics, topology and geometry of motion, which is a principal theme of this book. A third area treats the nature of energy transformation in machines such as the thermodynamics of prime movers (e.g. Thurston, 1878). A fourth theme of history treatises is the science of mechanics – the forces, torques, stresses and materials of machine design. From ancient times to the early 19th century, this latter subject has included the so-called *simple machines*; the lever, pulley, wedge or inclined plane, capstan or wheel and axle and the screw (see Figure II.3). The authors of books on the mechanics of machines were often mathematicians. For example the first appearance of a list of simple machines appeared in the work of the Aristotelian School. Later we see simple machines in the works of Archimedes and Hero of Alexandria. These studies treated statics or equilibrium of forces and in general were not concerned with dynamics in machines.

In the European Middle Ages, there were a number of philosopher-mathematicians whose works helped lay the basics in the concepts of power, force, velocity, accelerations and equilibrium, terms we take for granted in our modern treatment of mechanics. Histories of the early contributions to mechanics include those of Pierre Duhem (1906), Rene Dugas (1955) and Marshall Clagget (1959). In the 13th century Jordanus de Nemore pondered the concept of virtual work, the lever and the inclined plane. The Schoolmen of Merton College in 14th century Oxford made advances in the kinematics of instantaneous velocity and uniform acceleration. In Paris of the same century

Nicole Oresme introduced two-dimensional graphics to represent time dependent motion. However in the same century that theorists struggled with basic concepts of mechanics of simple machines Guido di Vigevano was writing his *Texaurus* (1335) and Konrad Kyeser was writing his *Bellifortis* (c. 1405) both presenting complex machines to lift and move heavy objects. Part of the modern fascination with Leonardo da Vinci was that he was not only able to study principles of statics and mechanics, including the simple machines, but he was also thinking about specific complex machine solutions to technical problems such as textile manufacturing or catapults for war.

In the late 16th and 17th century, mathematicians such as Nicholas Fontana (Tartaglia), Guido Ubaldo del Monte and Galileo Galilei, were still studying the mechanics of simple machines while designer-engineers such as Ramelli and Zonca were dreaming up ever more fascinating machines. What is also striking is that even when someone as broad a thinker as Leonardo studied both the mechanics of simple machines and the design of complex mechanisms, we do not see the use of the analysis of mechanics in the design of a particular machine very often in his work. For example if a modern engineer wanted to build Leonardo's machine to spin thread (*Codex Atlanticus*, Folio 1090r) he or she would want to know the value of the torque or moment of force required to turn the input shaft. Often however these 'theatre of machines' authors were themselves distanced from actual workshop craftspeople whose experience and intuition were essential in choosing the size, shape and materials for various machine components.

The major breakthroughs in the mechanics of fluids and solids came with the work of Galileo Galilei, Isaac Newton, Leonard Euler and many others such as the Bernoulli family in the late 17th and 18th centuries. The nature of force was made more precise and the dynamics of particles and rigid bodies were codified in the calculus of differential equations. Further, with the work of Euler and Bernoulli family, the rational study of structures was advanced to where one could calculate how structural members of machines bent and deformed and what was the nature of internal stresses in the elastic solid. We take for granted the idea that a structural element in a machine should be sized in proportion to the stress generated during the operation of the machine. But the codification of this idea in machine design textbooks did not come about until the 19th century.

As an example of the lag in machine knowledge between kinematics and mechanics we examine briefly the contributions of two mechanicians of the 16th century after Leonardo's death, Giudo Ubaldo del Monte [1545–1607] and Galileo Galilei [1564–1642]. Both are discussed in more detail in papers

by Teun Koetsier (2001a) of the Free University in Amsterdam, and Marco Ceccarelli (2006), of the University of Cassino in Italy. Both authors place Guido Ubaldo and Galileo in important positions in the history of machines. Guido Ubaldo was educated in Padua and Urbino. He worked as an architect and wrote several books, one of which was *Mechanicorum Liber* in 1577. He also corresponded with Galileo. His book on the simple machines acknowledged the earlier work of the School of Aristotle, and Archimedes. He also had read the work of Pappus of Alexandria that followed an earlier direction of reducing all the simple machines to the analysis of an equivalent lever system. Guido's treatment of simple machines is one of the first systematic studies of the post-classical period but he erred in his analysis of the inclined plane and by analogy the screw.

Ceccarelli (2006) points out that Galileo's *Mecchanica* was actually used as lecture notes at the University of Padua in 1597–1598. In his opening remarks, Galileo acknowledged the usefulness of machines in tasks such as lifting heavy weights. He then proceeded in a systematic way to analyze the balance of forces in the lever, capstan, pulley, and screw, noting that the screw can be thought of as an inclined plane wrapped around a cylinder. Galileo was aware of Ubaldo's manuscript and realized the latter's error in the treatment of the inclined plane. Galileo extended his analysis to Archimedes screw pump and also generalized the simple pulley to a compound pulley.

Koetsier (2001a) points out that rarely were these relationships between forces and moments in machines used to design working devices. One exception he points out is that of Simon Stevin [1548–1620], who besides writing theoretical treatises on mechanics, also designed windmills in the Netherlands in which he used some of the principles of force and moment balance to choose dimensions for the mill.

The separation of mechanics, kinematic design and construction of machines existed into the 19th century. Textbooks such as Willis (1841) and Rankine (1868, 1887) in England, Haton (1864) in France, Weisbach (1848), Redtenbacher (1861) and Reuleaux (1861) in Germany began to introduce both the kinematic motions and mechanics of forces into the teaching of machine design, especially the material properties of strength and concept of internal stress as a critical design factor. Principles of thermodynamics in the design of machines were not used until late in the 19th century (see e.g. Thurston, 1878). With the increase in the speed and power of prime movers and the spread of high speed electrical generators in the late 19th century knowledge of inertial forces and the use of the dynamic equations of motion of Newton and Euler began to appear in machine design at the dawn of the

20th century. However, the true realization of the use of mathematics and physics in the rational design of machines did not come about until mid-20th century.

MATHEMATICS VERSUS DESIGN?

In his 1992 book, *Engineering and the Mind's Eye*, the well-known historian of technology, Eugene Ferguson, challenged the modern trend of replacing traditional design courses with those in engineering science, mathematics and computer aided design [CAD]. At the end of his book he said:

If we are to avoid calamitous design errors – it is necessary that engineers understand that such errors are not errors of mathematics or calculation but errors of engineering judgment – judgment that is not reducible to engineering science or mathematics.

It is interesting that Ferguson, who had made a career of promoting the idea of the evolution of machines, seemed to be less a believer in the evolution of the *process* of engineering design. His book gave many examples of how machines evolved from the time of Leonardo to the industrial age of the 19th century. He also developed further the idea of the importance of visual thinking in creative design, a point he made in his earlier 1977 article published in *Science*. But at the end of his 1992 book Ferguson launched into a polemic on the dangers of too much mathematics in the teaching of engineering.

This debate about mathematics and design is very old. For example, Ferguson applauded Reuleaux's use of physical models in teaching, neglecting to note that Reuleaux's colleagues at the Berlin Technical University thought his whole premise of engineering was too theoretical, too mathematical and not based on engineering practice. Some biographers believe that Reuleaux in fact was pressured to retire early by many of his detractors.

It is probably true that as each generation becomes comfortable with a certain level of mathematics, say geometry in Leonardo's time, the introduction of another level of mathematics, such as integral calculus in Reuleaux's time, is seen as a threat to design intuition. In the 1960s, partial differential equations was added to the curriculum of undergraduate engineering, much to the dismay of many traditional engineers, Ferguson among them. In the 1980s non-linear differential equations and chaos theory was the latest mathematical hot topic. In the first decade of the 21st century, many young engineering professors are using optimal design codes, fuzzy logic, probability theory, neural network theory, genetic algorithms and methods of artificial intelligence that many older faculty have difficulty understanding. As machines

evolve, the tools and methodology to create new machines also evolve. For the machine engineer, three-dimensional thinking and visualization are still very important; but that does not mean that one cannot use CAD as a tool to further visual intuition. All mathematical ideas are tools for the designer, when properly viewed as such they help to develop '*educated intuition*'. Intuition is based on a set of mental constructs, such as mathematics and the physical sciences as well as on experience. It can be said that in Leonardo's time the machine first existed in the mind of the workshop mechanic and today it exists on a hard drive in a computer. But it is also true that before the creation of the CAD model the machine originated in the imagination of the designer.

II.11 ART AND THE MACHINE ENGINEER

C.P. Snow (1959, 1998) characterized the gulf between the humanities and sciences in his book *The Two Cultures*, as denizens of two tribes that have little common language or tradition. Other writers have divided these cultures in terms of *left brain and right brain*, or rational thought and intuitive thinking, a primordial yin and yang among humans. Though some may associate art with the humanities there are many common elements between art and science. One of the common links is engineering. Engineering is the creation of artifacts for practical use by humans. This endeavor involves both artisan skills as well as scientific and mathematical knowledge and uses a creative process that depends on both the past and a drive for the ‘new’.

Leonardo da Vinci and Franz Reuleaux had different degrees of identity with art, engineering, science and mathematics. Mathematics is often identified with the scientific process although not all mathematics is science and *vice versa*. While algebra and analysis may not be immediately identified with artistic endeavors, geometry and topology can be directly related to artistic skills and intuition. Leonardo was interested in geometric design as illustrated in his sketches in the *Codex Madrid* and other manuscripts. At the same time Leonardo defined his skills as an engineer as well as an artist in his famous letter to Ludovico of Milan; as able to design fortifications and civil engineering projects or in designing trebuchet to hurl stones at a city wall. These endeavors in turn involved drawing, perspective, optics and three-dimensional visualization.

Other artist-architect-engineers of the Italian Renaissance included Brunelleschi and Francesco de Giorgio Martini. In the late Renaissance, there were wonderful woodcut books of machine technology published by Besson (1578) in France and Ramelli (1588) in Italy that showed great artistic skill. These machine books are evidence that Leonardo was not unique in the combined skills of artist, architect and engineer though he may have been one of the greatest at them.

In the 17th century Robert Hooke [1635–1703], whose name is associated with the universal joint mechanism, came to scientific fame thorough his skill as a draftsman and artist as well as a fine instrument maker. His skills as an artist served him well when he published his *Micrographia*, a book of observations of nature, insect and botanical objects at the microscopic level. Like Leonardo, Hooke was skilled in both mathematical and artistic talents.

On the science half of the Two Culture divide, the industrial revolution of the 19th century saw the emergence of a *machine aesthetic* in design that led to some strange looking machines such as Greek columns on steam en-



Figure II.17. Architectural elements in steam engine design (Smithsonian Institution, Washington DC)

gines and locomotives (Figure II.17). The aesthetic movement in American machine design is reviewed in a book by John F. Kasson (1976), called *Civilizing the Machine*, especially Chapter 4, ‘The Aesthetics of Machinery’. Kasson makes the point that the machine for the young American nation represented some of the ideals of a republican democracy; efficiency, hard work, frugality and service. He cites a quote from Benjamin Franklin; “*To America, one schoolmaster is worth a dozen poets and the invention of a machine – is of more importance than a masterpiece of Raphael*”.

Americans embraced the aesthetic ideals of Greek architects not only in their architecture but in their machines as well, as illustrated in Figure II.17. But to European tastes, the American frills on machines were too garish as noted in an article in the British journal *Engineering*. Commenting about the machines at the Philadelphia Exhibition of 1876. “*There is maintained a tolerance of the grotesque ornaments and gaudy colors which as a rule than an exception distinguish American machines*”.

Kasson also notes that major popular technical magazines published wonderful and detailed pictures of machines. These included *Scientific American* and the patent journal *American Artisan* as well as the British journal *Engi-*

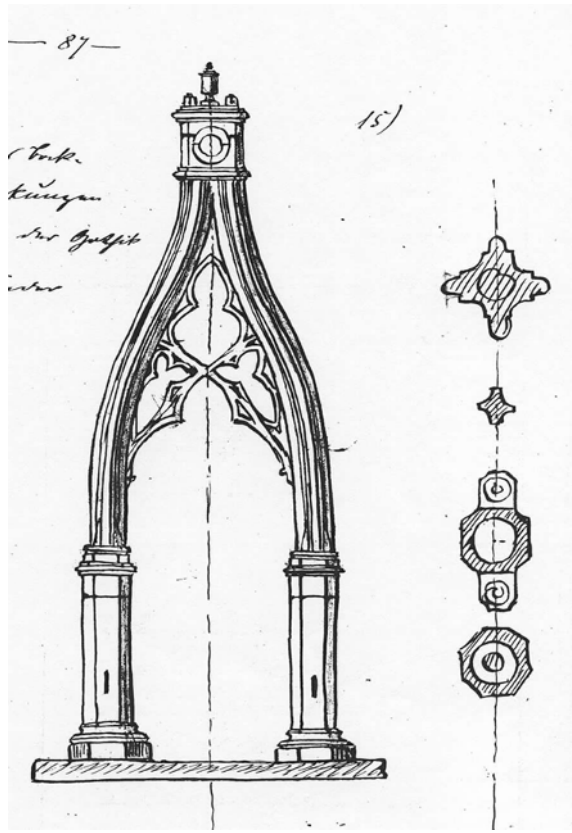

Figure II.18. Reuleaux's designs for bearings pedestals in machines (Courtesy Deutsches Museum Archive)

neering. The popular lithographic publisher Currier and Ives published many railroad images for rail companies that romanticized the locomotive.

Not all American machine designers resorted to superfluous frills notes Kasson. William Sellers, a notable machine manufacturer, avoided ornamentation and advocated a more clean, efficient look on the 'form follows function' aesthetic that characterized Reuleaux's values as a machine designer. Sellers is credited with introducing the now classic 'machine grey' look into American machines.

Franz Reuleaux and other engineers of the Machine Age embraced an aesthetic of design based on the idea that artistically pleasing structural shapes were more likely to be efficient in their use of materials (Figure II.18). His ideas were inspired by his mentor Ferdinand Redtenbacher of the Karlsruhe Polytechnic School in Germany. In the first pages of his famous book in ma-

chine design *The Constructor*, or ‘The Designer’, Reuleaux introduced the idea of ‘*bodies of equal strength*’ or structural elements in which every position in the body supports the same stress level as every other position. This design principle yields aesthetically pleasing structural shapes.

Reuleaux advised the student that if he were to choose aesthetically pleasing, smooth geometric shapes in his designs, the elements would be close to the optimum use of materials. He advanced a kind of ‘*form follows function*’ theory. Later it was discovered that structural shapes that had sharp changes in geometry were likely to result in concentrations of stress and potential failure of the material at these points. Thus Reuleaux’s aesthetic principle went beyond the sentimentality of classical Greek revival design but was based on ideas known today as *optimal design*.

This connection between art and mathematics has a long history as in the golden mean theory of human proportion as well as mechanical devices used by artists to draw perspective. In this theory the ratio of various dimensions of the body are in the ratio of phi; $\phi = (1 + \sqrt{5})/2 \cong 1.62$ (see e.g. Atalay, 2004). The ratio *phi*, was known to the ancient Greeks and this knowledge was known to artists and architects in the Renaissance period. Leonardo da Vinci’s famous drawing of a man with outstretched arms and legs in a circle exhibits this golden mean ratio phi and has an earlier antecedent in the work of Francesco di Giorgio. Both were inspired by a discussion by Vitruvius on the aesthetic proportions of the human body.

One of Reuleaux’s predecessors, Robert Willis [1800–1875] of Cambridge University, and a Fellow of the Royal Society, published a highly influential book on kinematics of machines in 1841. He also built a reputation as a historian of architecture of English cathedrals as well as the university buildings of Cambridge. Willis’ sketchbooks show great skill at drawing. Willis was able to straddle the two sides of Snow’s ‘Two Cultures’.

Franz Reuleaux also had professional connections to art. He was head of the association of Berlin art dealers for five years and was entrusted by the Kaiser to purchase art for the Royal Museum of Arts in Berlin of which he was a trustee (Zopke, 1896). His book *The Constructor* contained over 1200 illustrations and his personal sketchbooks show not only technical drawings but architectural and botanical objects as well. Reuleaux served as the Editor of a grand project to document the history of inventions with an eight-volume work entitled *Der Erfindungen (1889–93)*. This work is filled with many beautiful lithographs of technical objects, and marvelous Victorian style lithographs similar to Figure I.5, portraying allegoric references to both technol-

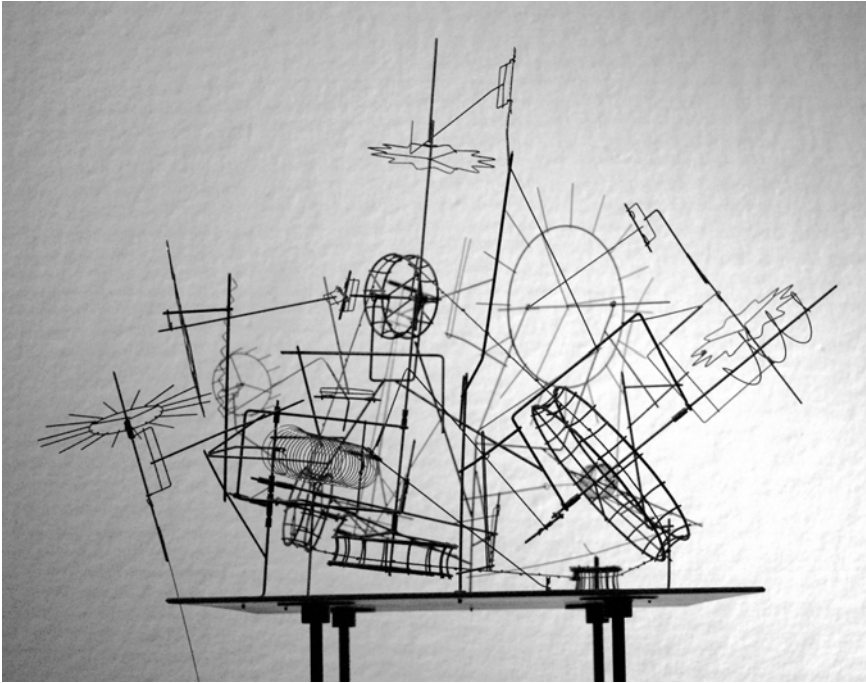

Figure II.19. Kinetic sculpture with gears by contemporary artist Arthur Ganson (MIT Museum)

ogy and cultural symbols. The spirit of Reuleaux’s sense of the aesthetic and technology is clearly in evidence in these volumes.

Reuleaux in his other famous book, *Kinematics of Machinery* (1875–1876), addressed the subject of creativity in machine design and said that the methodology of the engineer and the artist were similar. In his desire to communicate new ideas of kinematics of machines, Reuleaux created a museum of 800 models. These models not only embodied his aesthetic in machine design with their beautiful shapes, but the motions of many of the models are worthy today of the appellation, *kinetic sculpture*. Some of these models are shown in the figures in Part III. (See also the color plates of Reuleaux’s machines in this book.)

One of the pioneers of kinetic sculpture, Alexander Calder, was trained as a mechanical engineer at Stevens Institute of Technology in New Jersey. Calder popularized the gravity driven multiple pendulums called mobiles. Jean Tinguely another kinetic sculptor had no engineering training but spent his life creating what he called “*useless machines*”. The city of Basel Switzerland has devoted an entire museum to Tinguely’s kinetic art machines.

Another 20th century artist who used technology in his work was Man Ray [1890–1976]. Ray was trained in a technical high school in Brooklyn, NY and went on to become a force in the Dada and surrealist art movements often using technical objects in his photographs.

Robert H. Thurston, who was a world expert in the design of steam engines and corresponded with Reuleaux, created a mechanical engineering curriculum at Stevens Institute of Technology in New Jersey. Thurston became the Dean of Mechanical Engineering at Cornell and hired a young art instructor Hermon Atkins MacNeil [1866–1947] to teach engineers freehand drawing. A contemporary photograph of the art studio in the College of Mechanical Engineering shows drawing desks and plaster casts of bare breasted Greek statuary as well as geometric objects for drawing. Noting MacNeil's sculptural talents, Thurston encouraged the young artist to obtain training in Europe. In 1888 he went to Paris for study and returned to the United States in 1891 to work on the Columbian Exposition in Chicago. After another trip to Europe, MacNeil returned to the US as one of America's prominent sculptors. In 1915 he was commissioned to sculpt the bronze statue of Ezra Cornell on its campus. Oddly, MacNeil placed a telegraph receiver at the feet of Cornell. Cornell had worked with Samuel Morse in America's first telegraph line. Morse, another cross cultural artist engineer was trained at Yale as a portrait artist and made a living for several years as an artist before engaging a career as a telegraph engineer. ASME commissioned Hermon MacNeil to create a bronze bas-relief of Thurston, its first president. The above anecdotes are counter examples of C.P. Snow's *Two Culture rule*.

Although the lay public often views design of modern machines as unemotional, computer dominated and highly rational, there are aesthetic decisions in machine design, some abstract and others visible to the consumer. The tradition of artistic decisions in machine engineering has roots that span the centuries from Leonardo to Reuleaux.

Two contemporary kinetic artists who use machines and kinematic linkages are George Rhoads of Ithaca, New York and Arthur Ganson of Stoneham, Massachusetts (Figure II.19). Rhoads works with falling balls lifted and guided by mechanical mechanisms. His playful cages of colorful chaos are exhibited in over 200 public spaces around the world, including the Boston Museum of Science and the New York Port Authority Bus Terminal. His work is based on the chaos of dynamics and includes sound as well as motion in his art. One of his creations has special relevance for this book, is on the Spanish island of Tenerife, off the coast of Africa. This is the birthplace of the Spanish engineer, Augustin de Betancourt, whose 1818 book with Lanz became very

famous as a compendium of machine mechanisms. The museum at Tenerife commissioned George Rhoads to design a falling ball sculpture based on the mechanisms in Lanz and Betancourt (1808) and includes a dozen or more mechanisms in motion.

Another contemporary kinetic machine artist, Arthur Ganson, works with kinematic elements such as gears, chains and linkages (Figure II.19). Though more deliberate and purposeful in their motions than Rhoads', Ganson's machines have a stately, elegant presence as they perform their balletic routines. His work can be seen at the MIT Museum in Cambridge, Mass., as well as in the Smithsonian Museum in Washington and can be found on the web as well. In one memorable piece, Ganson has a machine disassemble a chair and reassemble it in slow motion.

THE MACHINE IN ART

Artists rarely include machine artifacts in their paintings. Human forms and emotions, animal and botanical life, natural landscapes seem to capture the imagination of artists more than the technical artifacts of humankind. Of course, architectural artifacts such as buildings, bridges, castles and other creations of civil and military engineering abound in art; but not so machines per se. There are exceptions and several examples can be found in the collection of Francesco I de' Medici [1541–1587] in the Palazzo Vecchio in Florence. Francesco had an interest in the sciences and manufacturing, especially porcelain making. He was also a patron of the arts. In 1570 he commissioned Vasari to design a small studio called the Studiolo. Several of the paintings portray technical activities such as wool making, glass making and a chemical laboratory. The 'Alchemy Laboratory' by Giovanni Stradano includes a screw press and the 'Wool Factory' by Mirobello Cavalori also exhibits several machines.

Another later contemporary of Leonardo was Albrecht Dürer [1471–1528], of Nuremberg who was the greatest woodcut and copper engraver of his time. He traveled widely including Italy and The Netherlands. Dürer wrote a treatise on art based on mathematical principles. In a famous woodcut of 1514, called 'Die Melancholie', he portrayed an angel with large wings, holding a measuring compass. There is also a measuring balance as well as stonemason's tools. In a series of fantastic woodcuts in 1515 called 'The Triumphzug Kaiser Maximilians' Dürer portrayed several wheeled coaches with elaborate gears including a lantern pinion and an endless screw (see Figures II.20 and II.21) (Scherer, 1907). A large human treadmill powers another wagon. One coach shows a lantern pinion driven by men with a crank

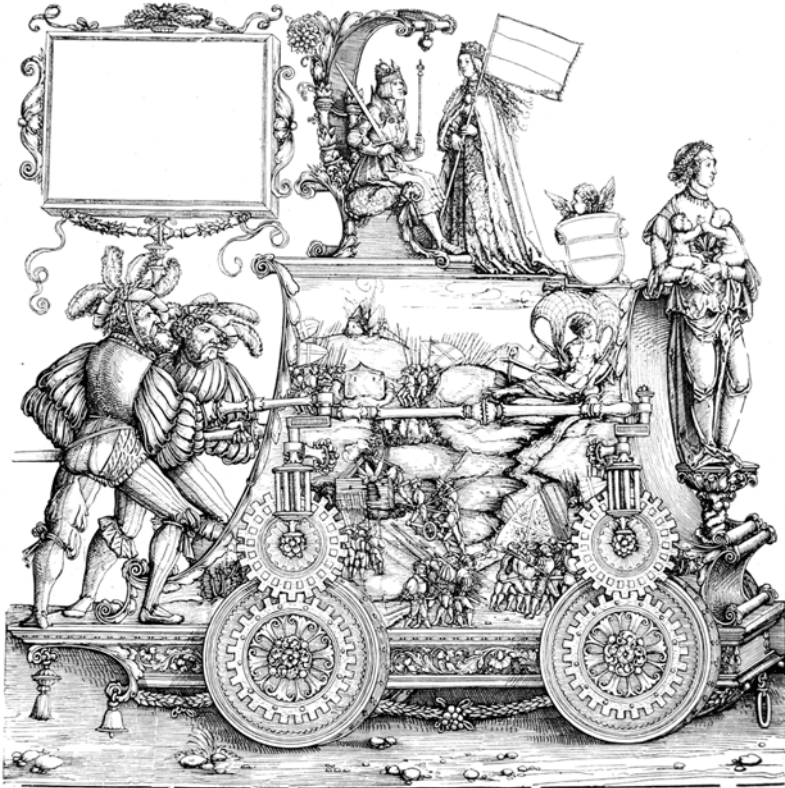

*Der Triumphzug Kaiser Maximilians
Um 1515

Figure II.20. Engraving by Albrecht Dürer; 'Triumphzug Kaiser Maximilians' (1515) (Scherer, 1907)

and linkage, with interlocking gear sets. The gear teeth have a square shape, unusual for the time (Figure II.20).

Machines were an integral part of the practice of civil construction and architecture. This was especially true during the building of the great cathedrals of Europe in the Middle Ages from the 12th to the 15th century. In several cases, the building of these magnificent structures was documented in painting. Paintings of construction machines can be found in the small book by Alain Erlande-Brandenburg (1995) *Cathedrals and Castles: Building in the Middle Ages*. For example, Jean Colombe in the 15th century made a painting of the reconstruction of Troye Cathedral that showed a treadmill winch, cranes and wagons. Around 1484, Diebold Schilling painted a series of pictures called *The Bern Chronicles*, which showed the lifting of heavy stone us-

ing block and tackle, a treadmill winch as well as grappling tongs. In Italy, the artist-engineer Mariano Taccola [b. 1381] published ten books on machines in 1449, *De Machinis Libri Decem*, that contain many small painted illustrations of machines. These books pre-date the unpublished work of Leonardo da Vinci who was born three years later in 1452.

In the late 19th and early 20th centuries there was a genre of art with industrial themes, smoking factories, rail and automobile vehicles etc. Two examples are Adolph von Menzel and Max Lieberman, both paintings are in the Berlin Staatliche Museen Nationalgalerie. Menzel's 'Iron Rolling Mill' shows a chaotic group of men and machines handling hot iron. Liebermann was an early German enthusiast of impressionism. In a painting called the 'Flax Mill' he shows a group of women in a factory setting, spinning yarn with ancient spinning wheels, which seems to be out of date with the technology of the mid-19th century.

In 1909, Italian artists formed an abstract Futurist movement that glorified dynamics, speed and machines. It included Giacomo Balla and Umberto Boccioni. Russian and French counterparts were Kasimir Malevich and Marcel Duchamp. These works appeared around 1910–1915. Duchamp's painting of *Chocolate Grinder*, 1914, shows three gear-like rollers on a table. In 1927, George Antheil wrote a film score entitled *Ballet Mecanique* for the surrealist artist Ferdinand Leger, which was envisioned to employ player pianos. The work celebrates the mechanical world of machines. A work critical of the industrial machine is the 1936 Depression era film of Charles Chaplin, *Modern Times* that shows Chaplin as a worker-hero in a semi-automated factory being mangled in the maze of the gears and rollers of the factory machines.

A French artist of the early 20th century who used the machine and machine elements in his art was Francis Picabia [1879–1953] for a time associated with the Dadaists. Wheels, pistons, gears, links and electromechanical coils and wires are all part of his paintings. His popularity reached a peak around 1921. A French critic at the time wrote this harsh verdict:

So Picabia has invented nothing, he copies. Yes, he copies that working drawing of an engineer instead of copying apples. To copy apples is understandable to everyone; to copy a turbine is idiotic.

Apples are fine, but machines are not suitable subjects for art claimed this critic. In the last century living things were acceptable in art but not things made by intelligent living beings, unless it's Andy Warhol's soup can. This was not always the case at least in 16th and 17th century Dutch and Flemish painting.

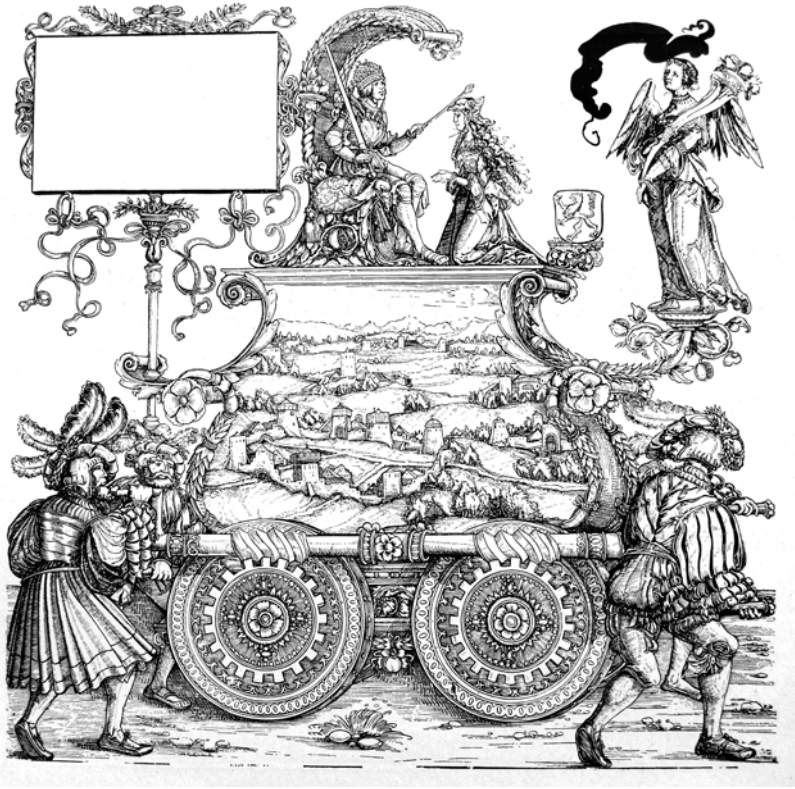

Figure II.21. Engraving by Albrecht Dürer: ‘Triumphzug Kaiser Maximillians’ (1515), showing two endless screw mechanisms (Scherer, 1907).

The portrayal of machines in art can also be found in the Dutch/Flemish painting of the 15th to the 17th centuries, by artists Heironymus Bosch a.k.a. Jerome van Aken [c. 1450–c. 1516], Pieter Bruegel [1530–1569], and Jan Van Goyen [1596–1656]. Machines often appear in landscapes. Some of the machines that appear in these works include, wheeled carts and wagons, windmills, water mills and construction cranes. This list does not include hand tools or structural artifacts such as bridges and castles. Nor does it include weaponry as depicted in battle scenes.

The work of Pieter Bruegel is interesting because machines appear in a significant number of his paintings. His *Tower of Babel*, shows the building of a large multi-story castle, and provides clues to the construction machines of the 16th century. Scanning this large work one can find the following machines and machine elements;

- Post windmill;

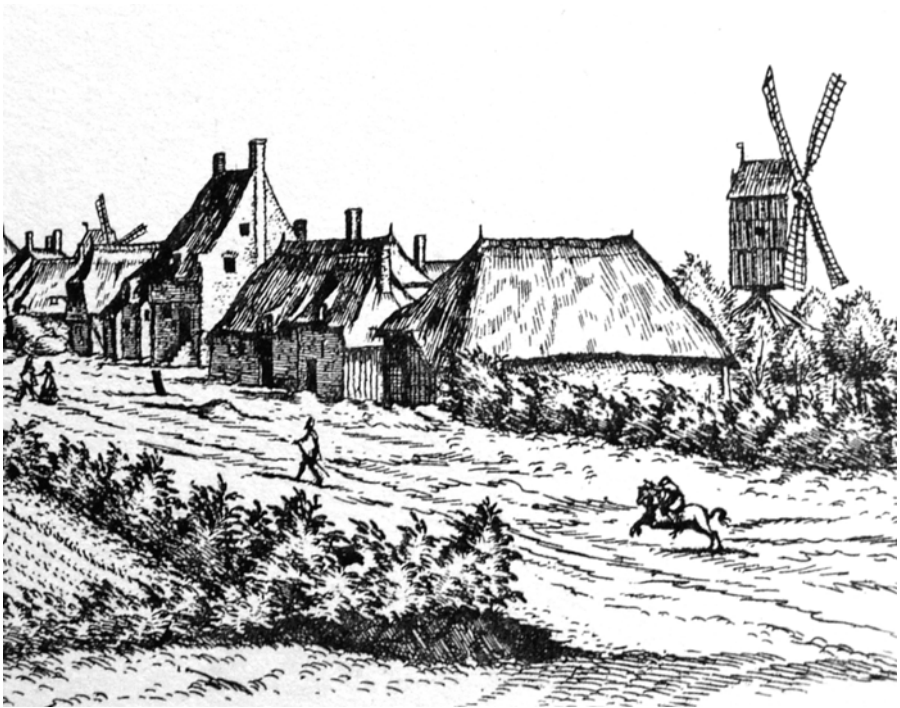

Figure II.22a. Print of Peter Bruegel [c. 1520–1569] of two post windmills. (In *Estampes de Peter Bruegel l'ancien*, by R. van Bastelaer, 1908)

- Water mill with a horizontal axis water wheel;
- Roman crane with a manned, ‘squirrel cage’ winch;
- Large winch;
- Pulley and rope lift;
- Lever type crane;
- Two and four, spoke-wheel carts and wagons;
- Ships with rudder control.

The horizontal axis windmill does not seem to have appeared in Europe until the 12th century. Bruegel painted a fairly detailed post windmill in a work entitled, *Christ Carrying the Cross* (1564). (See also Bruegel’s post windmills in Figure II.22a.) Another post windmill can be found in the background of a Breugel painting called *The Misanthropist* (ca. 1568). Apparently the windmill was a status symbol in Dutch/Flemish painting, for it was used by Hieronymus Bosch, as well as by Van Goyen. Bosch included a post windmill in his triptych *The Temptation of St. Anthony* in the right hand panel.

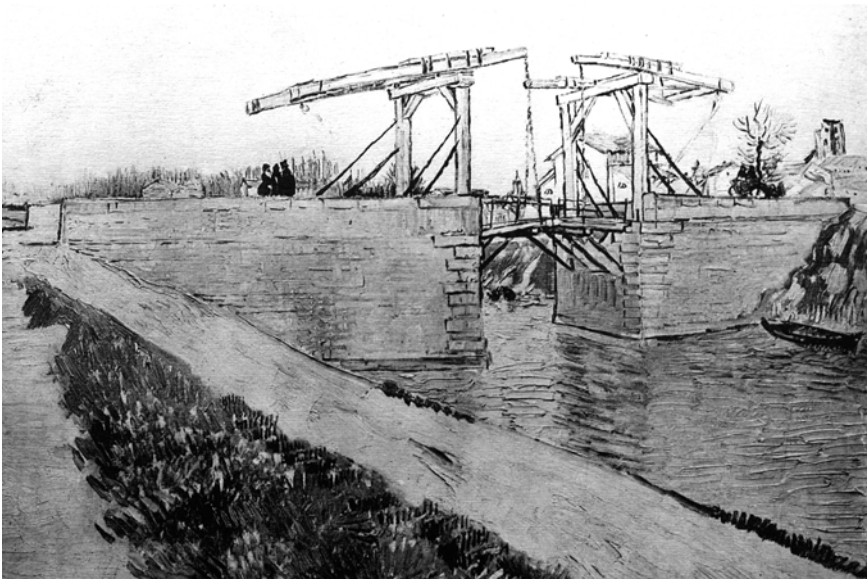

Figure II.22b. One of many studies for ‘The Drawbridge’ by Vincent van Gogh (c. 1888) with four-bar mechanisms. (In *Vincent van Gogh; A Biographical Study*, by J. Meier-Graefe, 1922, plate xxvii)

Another painter of the same period as Breugel, Simon Bening, used a large wooden crane of the treadmill winch type as a background to a Flemish calendar painting (*October*, ca. 1545). The painting depicts wine merchants in Bruges and the crane is lifting two large wine barrels.

An unexpected source of machines in paintings is the work of Vincent van Gogh [1853–1890]. Several of his landscape paintings show windmills. An early work features a watermill, *Kollen Watermill*, Nuenen, 1884. Another 1884 painting is a detailed portrait of a textile loom. Van Gogh also has a steam train, steamboat, a lift bridge (Figure II.22b) and folding mast boats in his paintings. His 1885 painting *The Quay*, shows a wharf in Antwerp with two steamboats. A 1887 work, *View of Paris*, features a windmill on a hill overlooking the city. His *The Bridge at Asnieres*, Paris 1887, prominently displays a steam passenger train across the top of the painting. Two windmills appear in the works, *The Hill of Montmartre with Stone Quarry*, 1886, and again in *Vegetable Gardens, Montmartre*, 1887.

Although Leonardo da Vinci made hundreds of drawings of machines and machine elements, none appear in his paintings. The only reference to a technical item is in Leonardo’s *Madonna and child* painting called the *Yarnwinder*, in which the infant Jesus holds a yarn spool. It is interesting

to note that Leonardo designed a number of textile working machines including an automatic yarn-winding machine in the *Codex Atlanticus* (Folio 1090v (393v.a; old)). His painting portrays the ancient yarn spinning method however.

The machine books of Besson and Ramelli contain wonderful engravings of machines, mill, pumps and war machines and include human figures alongside these technical artifacts. However skillfully these pictures are drawn, they were not considered artistic enough to have inspired the inclusion of machines in paintings by subsequent generations of art. On the other hand, Francesco di Giorgio designed a set of carved stone plaques in Urbino depicting various machines and artisan techniques that are considered works of art (see e.g. Galluzzi, 1997).

How did artist-engineers such as Francesco di Giorgio and Leonardo da Vinci separate aesthetic ideas from pragmatic concepts in their design thinking? Nor do we know whether Reuleaux's background in mathematical kinematics influenced his recommendations of art purchases for the Royal Museum of Art in Berlin. We can only speculate. We do know that both Leonardo and Reuleaux seemed to see art and design as a seamless activity. We shall not find a definitive answer to this question; but nonetheless it is interesting to explore.

II.12 CONCEPTS OF DESIGN AND INVENTION BY LEONARDO AND REULEAUX

How did the concept of invention arise in the history of machines? What is the path from workshop-craftsman to machine-engineer? Wheeled wagons and chariots appear in the records of the Babylonians, Egyptians (1800 BC), and European Celts (c. 800 BC). The use of chariots is recorded in the writings of the Greeks and the biblical texts of the Jews. Special workshops arose to produce the bronze wheels of the Celtic period in Europe and wheelwrights and millwrights were guild workshops in the Middle Ages. There is an abundance of evidence for the collective evolution of machine technology through the workshop craftsman traditions. That is, advances in machine design took place through small changes over many design generations of skilled craftsman, often stealing small improvements from other workshops or thorough travel and observations of working machinery, a kind of best practices model in the parlance of modern manufacturing engineering.

At some stage in this machine evolution the slow diffusion of knowledge was augmented with the shock wave of a new invention, i.e. a major departure from the conventional practice. The avalanche theory of invention is such that a slow period of improvements and materials development brings together opportunities that erupt in a spurt of new inventions. Certainly the case for this model can be made in the early days of the Watt–Boulton steam engine circa 1790. A more contemporary example is the internet and communications revolution of the late 1990s. Is there evidence that an avalanche development occurred in the Renaissance era of Leonardo da Vinci?

Invention is perceived to be the antithesis of the workshop evolution of machines emanating from the imagination of a single human. The machine inventor is one who conceives an entirely new configuration of materials and geometry that results not only in a better performing machine for existing applications but leads to entirely new applications. The most dramatic examples are those inventions that transform or revolutionize society and technology. Some inventors in this rank are James Watt and the Wright brothers, Orville and Wilbur.

Design on the other hand is an idea that brings to mind deliberate planning and purpose in contrast to invention. Design is identified with *process* whereas invention calls to mind *spontaneity*. Design begins with goals, clients, time and money constraints. It also implies optimization; i.e. finding the best size, shape, material, energy source to achieve the goals. Finally engineering design implies that the process of design has been codified, certified, generalized, by a professional class of practitioners. Like medicine,

accumulated knowledge in engineering is passed down to new professionals through many generations of apprentices, guilds, and professional societies. To transmit this knowledge in a way that is independent of culture, race, gender or human whim, engineering knowledge is codified using mathematics and scientific principles. The dehumanization of engineering design has even led some to believe that eventually computers will be capable of independent design and that machines in the future will be able to self improve and replicate themselves (Lipson, 2006).

Invention and engineering design have an inherent tension – the former representing human creativity and the latter rote process. These preconceptions are exaggerated since many inventions come at the end of a long process based on design evolution and careful experimentation. Also design processes often have bifurcation points in which the path chosen depends on human intuition and ‘educated guesses’.

This digression into the nature of design and invention is prefatory to a discussion of how Leonardo da Vinci thought about the creation of new machines and how four centuries later, engineers like Franz Reuleaux tried to resolve the tension between invention and design.

We remind the reader that Leonardo did not actually write books as we understand that term today. His ideas were written on thousands of sheets of paper that were bound after his death into what are now called *Codices*. The principal sources relating to machine design are the *Codex Atlanticus* in Milan, Italy and the *Codex Madrid* in Spain. These notebooks contain hundreds of drawings of machines and mechanisms most of which were likely copied from existing compendiums of machines such as Francesco di Giorgio Martini or copied from existing machine technology. There are a sufficient number of machine drawings in Leonardo’s work that appear to have no contemporary antecedents. These notebooks also contain aphorisms, comments and descriptions accompanying often intricate machine drawings.

In his Notebooks, Leonardo used the terms *invention*, *design* and *engineer* many times, providing evidence that such concepts were in common use in the Renaissance. His famous letter to the Duke of Milan is full of bragging about his engineering prowess. Only at the end of this long letter does he mention his skills as an artist and painter. The biographer Vasari described the Italian word *disegno* or design in Tuscan art. It is defined as faithful attention to observation of the original subject and embodying harmony in the elements of the finished object. We might assume that Leonardo also used this definition of design. In several places in his manuscripts he wrote about choosing the right machine to achieve given goals (*Codex Madrid I*, Folio 2r).

Every body requires its members and every art its instruments. And the moment that the whole is created, its parts are also created.

Or another quote relating to form and function (*Codex Madrid I*, Folio 96v):

Once an instrument is created, its operational requirements shape the form of its members. They may be of infinite variety, but will still be subject to the rules of the 4 volumes.

The reference to ‘four volumes’ is not understood, but is thought by some historians that Leonardo had plans for books on several topics such as rules of painting or rules for machine design.

Leonardo also wrote about inventions and inventors. He scoffed at those who merely copied and had no skills to create new designs (*Codex Atlanticus*, Folio 323r: folio 117r.b, old).

And if they despise me who am an inventor how much more should blame be given to themselves who are not inventors but trumpeters and reciters of the work of others?

A more positive quotation about invention may be found in *Codex Madrid I* (Folio 6r)

Peruse me of reader, if you find delight in my work, since this profession very seldom returns to this world, and the perseverance to pursue it and to invent such things is found in few people. And come men, to see the wonders which may be discovered in nature by such studies.

The idea of the *engineer* also appears in Leonardo’s manuscripts. Modern historians sometimes describe these men as artist-engineers, or architect-engineers such as Taccolo, Francesco di Giorgio, or Brunelleschi since their skills in design were often commensurate with their ability to draw, copy and sketch. These artist-engineers often had a good knowledge of geometry. Thus one can certainly find the seeds of a professional class of machine designers in the Renaissance, similar to architects, who are distinct from machine *builders* or craftsmen.

Another element of the evolution of machine engineering is the notion of *modular elements*, or the concept of what Reuleaux called *constructive elements* of machine design. Reti (1974) has been previously cited for comparing the drawings of machine elements and mechanisms in Leonardo’s *Codex Madrid* with the Reuleaux’s basic list of 22 *constructive elements* (see Table I.3). In the *Codex Madrid*, one can identify modular elements such as

gear pairs, pumps, cranked linkages, endless screws, pulley systems, ratchets, bearings, and escapements which went beyond the obligatory list of Aristotelian simple machines of the wheel, lever, pulley and inclined plane. Similar complex machines are found in many machine picture books before and after Leonardo, such as Roberto Valturio, Francesco di Giorgio, or Jacques Besson that indicates modularization in machine design was solidly under way by the early 15th century. Following the idea of an avalanche model for invention, one can argue that the plethora of machine elements existing at the time of Leonardo provided the critical mass of ideas that enabled him to propose so many new machines at the time. In the following quotation from the *Codex Madrid I* (Folio 82r), Leonardo recites a list of basic machine elements:

We shall discuss here the nature of the screw and of its lever, and how it [the screw] shall be used for lifting rather than for thrusting; –We shall also deal with the differences existing between a lever operating with a constant force, that is the wheel, and the lever of unequal power, that is the straight beam, and why the former is better than the latter and the latter more compact and convenient than the former. We shall also discuss the ratchet wheel and its pawl, the flywheel and the impetus of the motion, the axles and their wear: ropes and pulleys, capstans and rollers, will also be described.

Reti (1974) believed that this litany of mechanisms was a preface to a planned book on machine elements that, as in so many of Leonardo's projects were never realized.

An example of Leonardo's understanding of the concept of machine deconstruction into simple elements is his famous exploded view drawing of a ratchet lifting winch, from the *Codex Atlanticus*, showing the elements of ratchet, pawl, lever, bearings, etc., necessary to construct this device (Figure I.14). Both Leonardo and Reuleaux had a curiosity about unconventional kinematic mechanisms. One example, rarely described by other machine theorists, is a spherical or 'globoid' gear design, shown in Figure II.23.

Another element of machine engineering is the identification of *best practices*, i.e. a summary of expertise, especially successes and failures in contemporary machine design and construction. In another quotation from *Codex Madrid I* (Folio 117v), Leonardo refers to the importance of practical experience in the design of machines. In a long discussion on the rules for designing gears and gear teeth he says:

Experience about the shape of the wheel's teeth. If you wish to know the true form of the faces of the teeth of toothed wheels, go to the

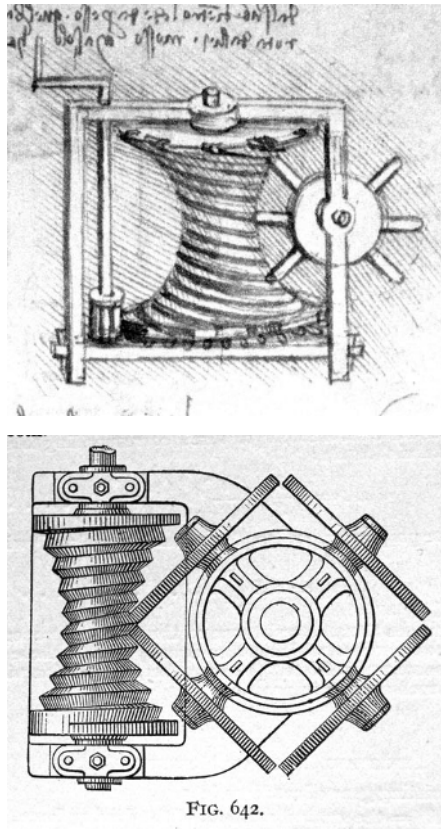

Figure II.23. Comparison of 'globoid' gear designs of Leonardo da Vinci (top) and Franz Reuleaux (bottom)

mills where such teeth are, by long use, worn out. There you shall observe the shape of what is left on the moving and on the moved tooth. And if you examine them well, you will find out by experience, the shape that by necessity must be given to the faces of such teeth.

In many places, Leonardo makes mention of failures in design and how to avoid them (*Codex Madrid I*, Folio 20r).

... it is evident that the teeth of the pinion will wear down 10 times faster than those of the wheel. Remember that friction wears gear teeth down.

A comparison of Leonardo's design ideas with those of Reuleaux is a leap forward through 400 years of machine invention and development especially the

18th century work of Newcomen and Watt and the steam engine. Reuleaux's books on machine design are a good place to see the end point of the evolution of machine construction from the workshop model in England to formal mechanical engineering training in the Germanic countries, or what in German is called *Maschinenbau* or 'machine building'. In Reuleaux's books we see explicit use of mathematics, experimentally measured properties of materials for machine construction, summaries of best practice and modular machine elements and mechanisms. Similar formulas can be found in other German books such as Julius Weisbach of Freiberg or Reuleaux's mentor, Ferdinand Redtenbacher of Karlsruhe.

Lest one think that Reuleaux fostered a dull, rote order of machine design, one can find in his *Kinematics of Machinery* (1876) a passionate plea for a study of synthesis and 'invention' and an admission of the failure of machine theory to come up with a process of synthesis in machine design. 'How did Watt invent the straight-line mechanism in the steam engine?', Reuleaux asked rhetorically. He quoted Goethe and Isaac Newton and proposed a program for synthesis:

Essentially invention is nothing less than induction, a continually setting down and therefore analyzing of the possible solutions which present themselves by analogy. The process continues until some more or less distant goal is reached.

Like some Renaissance writers, Reuleaux believed that artists and inventors used similar methods of thinking. He did not espouse the hero-inventor model of machine development. He viewed both scientific discovery and technical invention as evolving from a tension between the two, sometimes within the same person:

In inventing the steam engine, Papin was as much a physicist as a mechanician, and the same may be said of Watt when his searching genius grasped the subject.

It is clear that Reuleaux viewed the development of new machines as one of evolution, and that every invention has had an antecedent developed further by clever inventors, new scientific discoveries as well as the marketplace (*Kinematics of Machinery*, 1876, p. 231):

Very gradually each invention came to be used for more and more purposes than those for which it was originally intended, and the standard by which its excellence and usefulness were judged was gradually raised. — These attempts resulted in further improve-

ments and these in turn led once more to new applications and more extended use.

The tension between rational design and invention can be seen in the nature of Reuleaux's books. His popular handbook *Der Constructeur* (1861–1893) or 'The Designer', went through four editions in four languages, was a model of a list of rules and guidelines for machine designers. His earlier *Kinematics of Machinery* (1876), on the other hand, sought to posit new ideas that would lead to the discovery of principles of invention and synthesis in machine design. He proposed a representation of machines with abstract symbols as a kind of language of invention while at the same time incorporating topological ideas that could relate one mechanism to another.

Searching for an inherent order in the hundreds of new machines that were appearing in the 19th century machine age perhaps was partially a product of Reuleaux's service on the Prussian Patent Board for eight years; how could one recognize a new machine as truly a patentable invention and not merely an extension of some prior device? Even when he acknowledged that some new machine was clever, he was critical in his evaluation of its practical use, as when he said that inventors of rotary engines ignored the practical constraints of friction and wear in the seals between moving parts, a criticism that plagued the modern attempt at a rotary piston machine in the Wankel Engine. Still Reuleaux could express a romantic vision of the Machine:

[Mechanisms] . . . were the soul of the machine ruling its utterances – the bodily motions themselves – and giving them intelligent expression. They form the geometric abstraction of the machine.

GEAR DESIGN: FROM ART TO THEORY TO CODES

The development of the portable prime mover in the late 19th century, such as the internal combustion engine and the electric motor, initiated a shift in the practice of mechanism design away from linkage systems to gear train mechanisms. Today gear systems play an overwhelming role in machine design especially in transportation applications such as automotive transmissions and jet engine design. It is natural to ask what contributions did Leonardo and other Renaissance engineers make to the practice of gear systems and how did Reuleaux and his contemporaries further the theory of gear mechanisms.

The history of gear technology can be found in great detail in the German text of Graf von Seherr-Thoss (1965) and in the short American monograph by Dudley (1969). Seherr-Thoss is an academic work and has references to both Leonardo and Reuleaux; he cites Reuleaux several dozen times. The

book by Darle Dudley was published by the American Gear Manufacturers Association (AGMA), and is more practice oriented. Dudley has only a passing reference to Leonardo and no references to Reuleaux or any other German text. The AGMA book does mention the contributions of Robert Willis of Cambridge University who was a predecessor of Reuleaux. Toothed wheels include not only gears but also ratchets and intermittent mechanisms such as the Geneva wheel. Low number toothed wheels have also been used for pumps as in the two-tooth Root's blower (see e.g. Reuleaux, 1893, p. 221, Fig. 967). But we will focus here on gear systems for torque and speed transmission. *Spur* gears have parallel axes. *Conical* or *bevel* gears have inclined intersecting axes. There are also spiral and worm gears as well as hypoid gears that have non-intersecting inclined axes.

From the view of Aristotle's simple machines, Figure II.3, toothed wheels or gear pairs are extensions of the principle of the lever. Early gear-pairs were simply a wheel with a series of pegs in a circular pattern on the wheel. The lever arms were the radii of the two wheels. When the two lever arms deviated from a co-linear alignment, a new set of pins became engaged. During the contact of the two pins, the well-known lever law where the ratio of the torques on the wheels is inversely proportional to the ratio of the rotation speeds of the levers is valid. These gears were often made out of wood. Brass gears with teeth cut on the circumference also have ancient origins as in the Greek Antikythera mechanism shown in Figure II.1, which contains many planar spur gear pairs with interlocking teeth and is dated around the first century BCE. In addition to applications as torque converters, gears also played a prominent part in clocks and automata design. Both types of applications are found in Leonardo's manuscripts.

There are hundreds of drawings of gear systems and many applications of gear trains in Leonardo's manuscripts as well as in the drawings of his contemporaries such as Francesco di Giorgio and Roberto Valturio. The variety of types of gears in Leonardo is much greater than other engineering works of the Renaissance. Dudley (1969) credits the artist Albrecht Dürer with the early study of epicycloids in 1525 and Girolamo Cardano with the mathematical study of gears in 1557. There are both lantern pinions and spur-gear pairs in the book of Ramelli.

Leonardo da Vinci's interest in gear design is illustrated in the quotes in the above paragraphs on design. Leonardo's love of gear systems has been noted by the German authors Grothe (1874) and Beck (1899) as illustrated in Figures I.19 and II.24. Leonardo not only used the lantern pinion, common in his day (Figures I.16 and I.12b), but also has many other types including

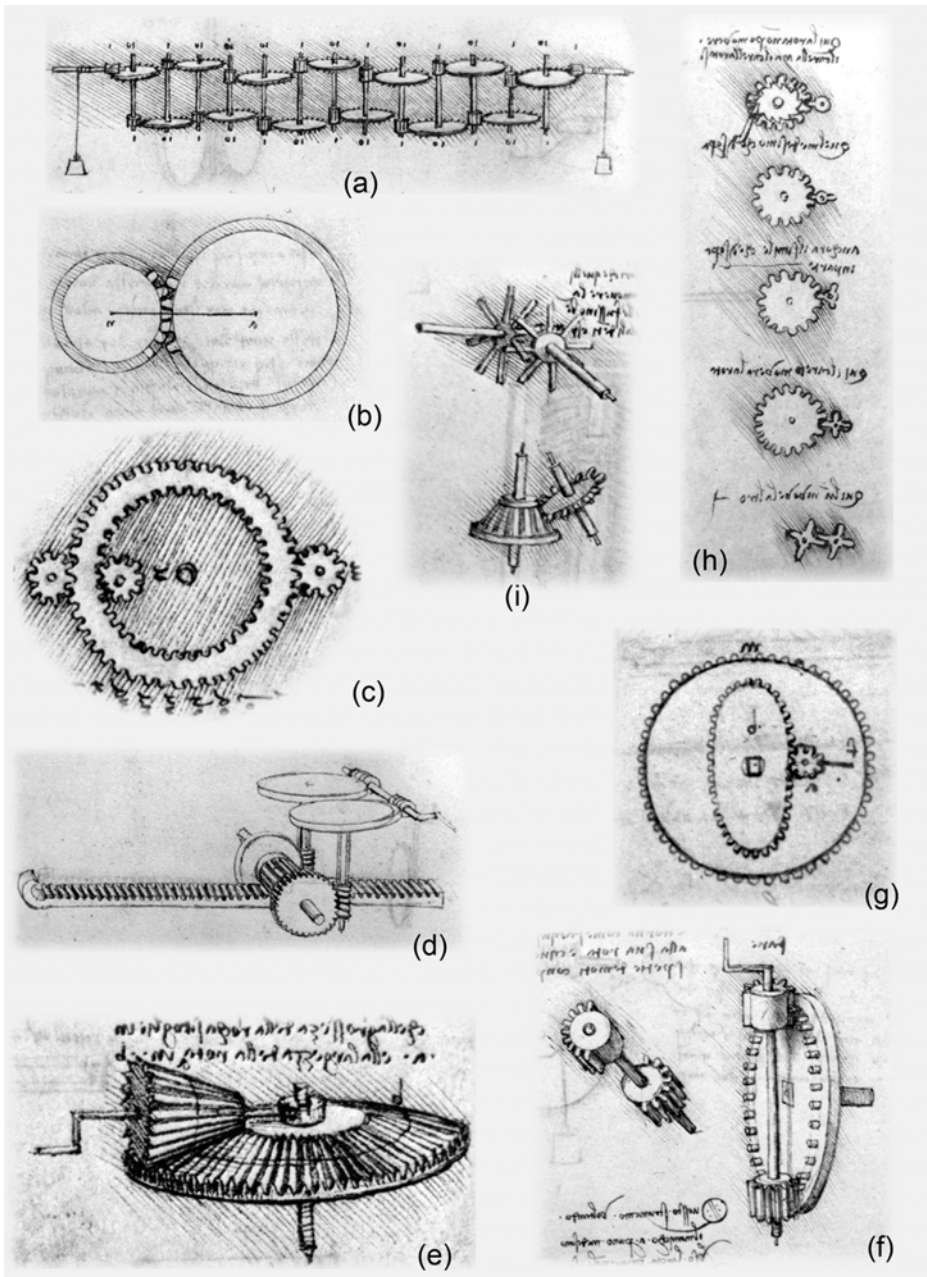

Figure II.24. A sampler of gear designs by Leonardo da Vinci (*Codex Madrid I*)

a planar spur gear and pinion set with teeth shaped similar to epicycloid gear teeth used a century later (Figure I.11c). Another unique Leonardo gear was a worm gear with a helical screw shaped to fit its mating toothed wheel as shown in the top left sketch of Figure I.3b. The shaped worm gear is similar to a design found in Reuleaux's machine design book of 1893.

Leonardo also seems to have understood that the sliding contact of two pins on different gear wheels would result in a changing speed ratio. The problem of non-uniform gear wheel motion was not well understood until the late 18th century in the work of Leonard Euler and not put in wide practice until the 19th century. The ideal motion of a gear pair is the same as two friction wheels in contact. Steady rotation of one results in steady, uniform motion of the other. Around 1754, Euler discovered that if the shape of the gear teeth were epicycloids or involute curves, then uniform motion of one gear would produce uniform motion in the other. The epicycloid curve is generated by a point on the outer rim of a circle, rolling on another circle. The involute curve is generated by the unwinding of a string, wrapped around a circle. Reuleaux created models to illustrate these two types of gear teeth shapes in the Voigt catalog, models Q3 and Q4 which can be seen on the KMODDL website (<http://kmoddl.library.cornell.edu>).

Reuleaux devoted a large section of his 1893 book *The Constructor* (pp. 129–148) to the discussion of gear design. His earliest work goes back to his book with Moll in 1854. Some of this material was inspired by the book of Robert Willis (1841). For slow speed operation, gear teeth have to exhibit strength under load, resistance to cyclic stress fatigue and produce low noise (see e.g. Buckingham, 1949). Reuleaux (*The Constructor*, 1893, §213) also dealt with the problem of gear friction loss. In his book he discussed epicycloid and involute shaped gear teeth, thumb shaped teeth, pin teeth, bevel gearing, worm drives and a strange set of gear pairs called globoid spiral gears.

Perhaps Reuleaux's greatest contribution to gear theory was the recognition of the gear pair as part of a kinematic chain (*The Kinematics of Machinery*, 1876, §58). As an example, for the spur gear pair shown in Figure I.3a (lower right sketch), there are three elements in the kinematic chain, two gears and a link supporting the two revolute bearings for the gears. If the link is grounded, the mechanism is a classic spur gear-pinion motion. If on the other hand the large gear is fixed, then we have a sun and planet gear system or planetary gear pair where the link arm rotates. James Watt used this form of the triadic gear chain, in his improved steam engine. It is interesting that Leonardo also sketched a number of planetary gear systems as illustrated in

Figures I.19 and II.24c. Because the basic twin gear pair has two revolute joints and one tooth pair contact, its representation in Reuleaux's symbol notation is $[C_z C_2^{\parallel}]$. The C_z stands for a tooth contact ('z' stands for the German 'Zahn' or tooth) and C_2^{\parallel} stands for the two revolute joints connecting the gears with the bearing arm (see also Section I.8).

Franz Reuleaux created a large variety of gear train models for the Voigt catalog as in the model series G, Q and 'O' (see KMODDL, <http://kmoddl.library.cornell.edu>). Reuleaux likely copied many of these model designs from his former mentor Ferdinand Redtenbacher at Karlsruhe, who published detailed designs of his models in *Die Bewegungs Mechanismen*, 1866. These models can be viewed also on the KMODDL website.

In addition to the design of gears themselves, the manufacture of gears and the detailed cutting of teeth became an important step in creating readily available gears for machine designers. A precursor to gear teeth cutting was the automatic cutting of screw teeth as used in worm gears. Leonardo da Vinci designed a machine to cut screws in *Manuscript G*, Folio 70v. On this folio he gives instructions along with the sketch of the machine:

This is the way to make a screw. You turn the middle wheel, which rests on the screw, which you wish to make. If you wish to make screws with greater or lesser inclined threads, then remove the wheels s and f and replace them with wheels a and b or the wheels c and d. (See Hart, 1961, p. 279)

A screw cutting machine can also be found in Besson's *Theatrum instrumentorum et machinarum* of 1578. (A digital copy can be found on the Smithsonian Institution Libraries website.)

In mid-20th century machine design, most mechanical engineers would have learned about gear design and its arcane technical terminology of pitch circle, addendum and dedendum, pressure angle and involute curves. In the early 21st century, gear systems have become modularized, packaged and ordered from an on-line catalog. The geometrical mathematics of gear teeth, as well as the stress-patterns generated at the teeth contact, are now buried in computer codes known only to a few specialists. Like the design of classical circuits in electrical engineering, now replaced by multi-circuit chips, the evolution of gear design has placed it out of the engineer's set of tools today. In some sense the cycle is complete, from the secret workshop of the Renaissance to the mathematics-based design texts of the Industrial Age to the proprietary computer codes of gear-manufacturing corporations, which have become versions of modern workshops: another example of lost knowledge in machine design.

II.13 MODELS AS THE NEW 'THEATRE OF MACHINES'

The use of models in engineering has had, until the last quarter century, a long and useful history. Filippo Brunelleschi [1377–1436], the architect and engineer of the cathedral dome in Florence, is known to have created construction models, including machines. Vasari in his biography on Leonardo da Vinci spoke of Leonardo making models to raise the Church of San Giovanni using levers cranes and screws. The use of sculptors' models (*bozzetto* (Itl.), *maquette* (Fr.)) of full scale works of art has a long tradition and making physical models to convince the funding patron to pay for new construction or a new machine has a long precedent.

In 1683 there appeared a remarkable exhibition in Paris; a display of mechanical models, some as tall as two meters, based on the 'Theatre of Machines' books of Besson and others (Endrei, 1968). The exhibition contained 30 to 40 models. There was even an informal catalog published for the public. This exhibition was one of the many scientific and technical fairs to come in the next two centuries including the much grander London Exhibition of 1851. Such public displays of models and full-scale prototypes of machines created another venue for the transmission of technical ideas as part of the evolution of machines.

In 1570, Francesco de Medici, the Grand Duke of Tuscany, invited Vasari to design a small studio in the Palazzo Vecchio in Florence called *The Studiolo*, to display paintings and to house his collections of geological items and chemical apparatus. During the next two centuries it became fashionable for the wealthy and royalty to amass large collections of artifacts sometimes called '*Physical Cabinets*' including botanical and geological specimens, and scientific apparatus. Examples of such 'scientific cabinets' may be found throughout Europe in the 17th and 18th centuries during the so-called Age of Enlightenment. The scientific collections, sometimes known as '*brass and glass*', included astronomical instruments such as astrolabes and telescopes, chemical, acoustic, electrical and mechanics apparatus. The mechanics models often consisted of simple experiments to illustrate the principles of dynamics or statics but rarely anything about machines except the simple 'machines' of the inclined plane, wedge, screw and lever.

Two examples of Royal Scientific Cabinets are in the Mathematisch-Physikalischer Salon of the Zwinger in Dresden and The Hauch Collection outside Copenhagen. Oddly even in the late 18th century and into the 19th century, these collections rarely contained any models of machines and kinematic mechanisms except the simple machines. In Sweden an engineer named Christopher Polhem [1661–1751] built his own *Laboratorium Mechanicum*,

in which he designed models to represent basic machine components and mechanisms, that he called a *Mechanical Alphabet* (see e.g. Johnson, 1963). Today these models are in the Swedish National Museum of Science and Technology.

A physical cabinet collection that includes kinematics as well as physics and chemistry is in Florence at the Fondazione Scienza e Tecnica. In the mid-19th century it acquired approximately 100 Schröder kinematic models from Darmstadt. This museum, which is off the beaten path, is an undiscovered jewel in Renaissance art-dominated Florence. (The Schröder models in this museum may be seen online at the KMODDL website.)

Robert Willis [1800–1875] of Cambridge University was a theoretician in kinematics who anticipated the machine ideas of Reuleaux in his book of 1841. We know that Willis had built a collection of kinematic models for teaching and demonstration. He succeeded Professor William Farrish to whom Willis attributed his interest in mechanical models. However, there is little physical evidence of their existence today. In the 1870 edition of his book, he described and illustrated ten different models for linkwork, including four-bar linkage, a slider-crank mechanism and a universal joint of Robert Hooke [1635–1703]. Willis also published a short book with descriptions and drawings for ‘teaching apparatus’. From the drawings it appears he preferred to work in wood and brass. One of the premier brass and glass workshops was Deleuil in Paris. An 1865 catalog reveals few kinematic machine models except two designed by Robert Willis. One of these models is in the Cornell University Kinematic Collection.

Around the same time in Germany Johann Andreas Schubert [1808–1870], a well-known engineer and professor at the Technischen Bildungsanstalt Dresden built a similar model collection of wood and brass kinematic mechanisms. He also published a textbook on machine engineering in 1842. Several of Schubert’s models can be seen at the Technical University in Dresden (Mauersberger, 1997).

MODELS OF LEONARDO’S AND REULEAUX’S MACHINES

Leonardo’s Machines

Although we have thousands of Leonardo’s original drawings, there is no surviving evidence of any machine artifacts such as models, prototypes or full-scale devices made during his lifetime. Had he been a builder-architect in the mold of Brunelleschi he would have had to make models for design competitions in order to win contracts, as did Brunelleschi for the dome of Florence’s

cathedral. Except perhaps for some temporary props and stage equipment for pageants to entertain the Duke of Milan, it is unlikely that Leonardo ever built any of his machines nor made many models of them.

Today one can find many models, both real and virtual, based on the drawings of Leonardo (Figure II.25). One of the most famous sets of Leonardo models was commissioned by the Italian dictator Mussolini for an exhibition in 1939 in Milan as a part of an effort to build national pride in Italian history. The 200 models were built by an Italian engineer, Roberto A. Guatelli at a cost of \$250,000 (*Time Magazine*, May 29, 1939, p. 39). These models went on tour and ended up in Japan where they were destroyed during World War II. After the War, Guatelli was commissioned to make a smaller set of 66 models for an exhibition at IBM headquarters in New York City in 1951. With the recent demise of the IBM museum in New York, these models have been dispersed and are on occasional tour in various exhibitions.

There are several museums in Milan, Vinci, Florence and France in which models of machines and mechanisms supposedly based on Leonardo's drawings are on display (Figure II.25). The Leonardo Museum in Vinci boasts a collection of over 60 models in the medieval Castello Guidi. Most of these models are made of wood and some are almost full scale. There is also a collection of 40 models at Clos-Luce Amboise, France, that was the last residence of Leonardo before he died.

One of the problems of creating three-dimensional models from two-dimensional drawings and sketches is the lack of complete information without multiple views of the object. The model designer also has to assume kinematic relationships between parts of the machine that might not be evident from the sketches. For example, in Milan, the science museum has constructed a working textile-weaving machine based on one planar incomplete sketch of Leonardo. Most of the details of this full-scale model had to be created by the modern designer. Its relation to Leonardo and the Renaissance is therefore suspect. Another model one can sometimes see in Italy is the so-called two-wheeled bicycle, supposedly based on a drawing in the *Codex Atlanticus* of Leonardo. Many scholars believe that this drawing and a few others in the *Codex Atlanticus* were added to the manuscript later as the style and quality of the drawings do not fit that of the master. Some critics of Guatelli also claim that he sometimes took license in interpreting Leonardo's drawings when he made three-dimensional models.

Recently there has appeared a beautiful book entitled *Leonardo's Machines* (Taddei et al., 2006) by a graphics group out of Milan called 'L3' based on three-dimensional computer aided design software CAD, so-called

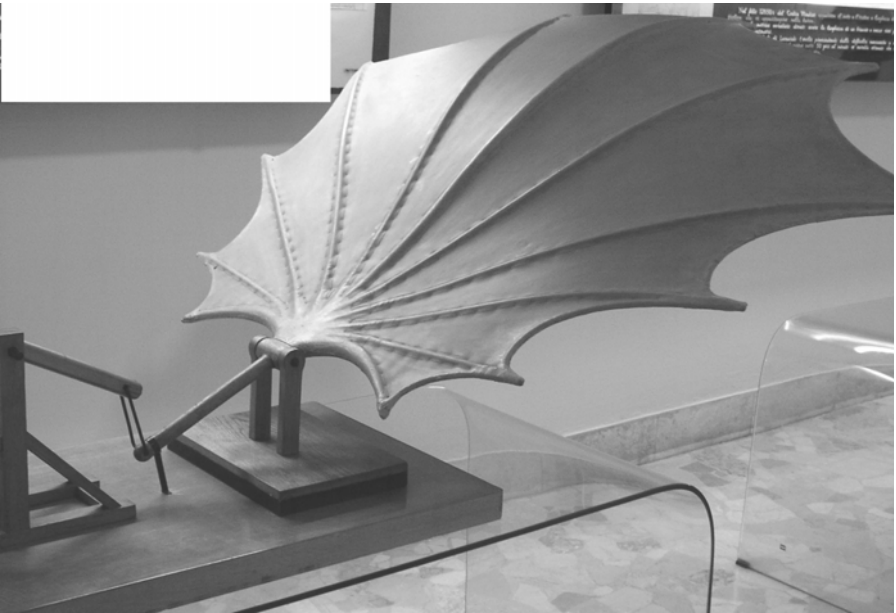
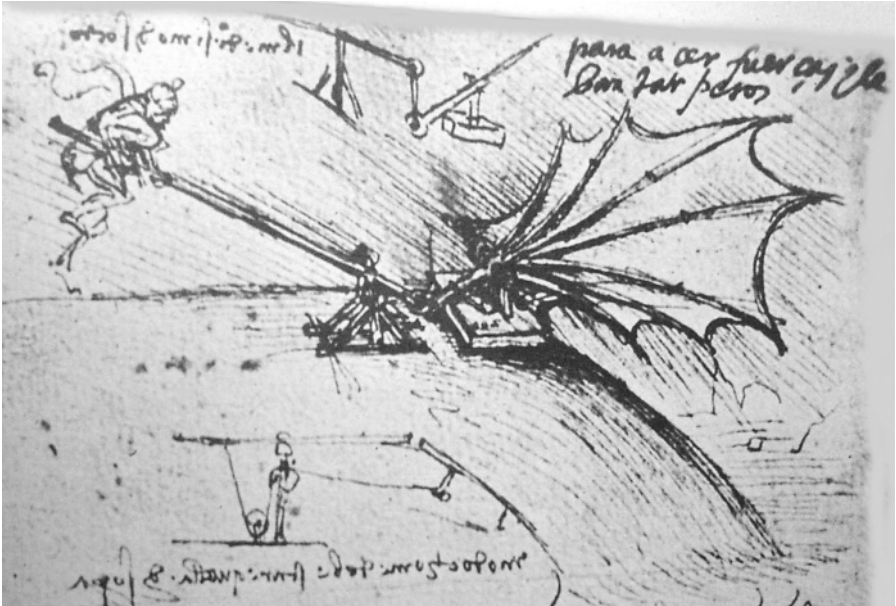

Figure II.25. Top: Leonardo da Vinci drawing of a wing in the *Paris Manuscripts*; Ms. B Folio 88 verso. Bottom: Model of a wing by Leonardo in the Museo Nazionale delle Scienza e della Tecnica Leonardo da Vinci, Milano

multi-body codes. This work has appeared in both a textual and CD format, where in the latter one can see the models move. Again the creators have added many details to these virtual models that are not in Leonardo's drawings.

With most modern reconstructions of Leonardo's machines, there is rarely any discussion of whether Leonardo actually invented these devices or merely copied them from existing devices or from manuscripts and books of earlier engineer-architects. For example the log-sawing machine in *Codex Atlanticus*, Folio 1078a-r (folio 389r.a, old) is often given as an example of Leonardo's invention of manufacturing automation. This machine drawing also appears in the 13th century sketchbook of Villard de Honnecourt and later in the book of the Sieneese engineer, Mariana Taccola, in the early 15th century. A similar design appeared in a book of machines by Francesco di Giorgio Martini circa 1450, likely copied from Taccola which in turn was likely copied by Leonardo, since he had a copy of Francesco di Giorgio's book in his library. In fairness to the latest picture book of models by the Milan group, there is mention that the origin of Leonardo's design for the automatic log-sawing machine probably came from Taccola. But this historical frankness is often missing in other Leonardo model museums.

Reuleaux's Models of Kinematic Mechanisms

In 1837 Jacob Peter Schröder [1809–1887] of the Polytechnisches Arbeitsinstitut Darmstadt, Germany, began developing pedagogical models of mechanisms. He was a teacher of projective geometry and also manufactured sewing machines. His catalog of 1884 lists medals awarded for his models at exhibitions in Berlin (1844), London (1851), Paris (1867), Vienna (1873), Philadelphia (1876), Sidney (1879), and Melbourne (1880). His kinematic models of cast iron were copied after the lecture notes of Professors Ferdinand Redtenbacher of Karlsruhe, Franz Reuleaux of Berlin and Carl Moll of Riga. Reuleaux and Moll were former students at Karlsruhe. Also Reuleaux had been on the judging panels of a number of these exhibitions including the Centennial Exposition in Philadelphia. The award citation for the Schröder models reads:

Commended for the great variety and excellence of their celebrated models as appliances for instruction in mechanical engineering and architecture.

Some of the Schröder catalog pages show up years later in the 1912 model catalog of the *Peter Koch Modellwerk*, Cologne, without any attribution to

Table II.5. Model collections of kinematic mechanisms

Location	Institution	Approx. No. Models	Vintage	Designer
Aachen, Germany	RWTH-Technische Hochschule	300	modern	
Berlin, Germany	Technische Universität	40	modern	
Boston, MA, USA	Boston Museum of Science	120	1940s	Clark/Brown
Cambridge, UK	Cambridge University	40	19th–20th C.	
Chemnitz, Germany	Technische Universität	?	modern	
Columbia, PA, USA	Nat. Clock and Watch Museum	80 Escapements	17th–20th C.	
Columbus, OH, USA	Ohio State University	50	1950s	Illinois Gear Co. 18th C.
Denmark	Hauck Foundation	?		
Dresden, Germany	Technische Universität	120	19th–20th C.	
Florence, Italy	Fondazione Scienza e Tecnica	100	19th C.	Schröder
Hannover, Germany	Technische Universität	20	c. 1880	Reuleaux
Hannover	Technische Universität	200	modern	
Ithaca, NY, USA	Cornell University	230	1882	Reuleaux/Voigt
Ithaca, NY, USA	Cornell University	20	1869	Schröder
Karlsruhe, Germany	Universität Karlsruhe	100	c. 1866	Redtenbacher
Kyoto, Japan	Kyoto University Museum		c. 1890	Reuleaux/Voigt
London, UK	Science Museum	20	19th C.	Schröder
London, UK	Victoria and Albert Museum	Escapements		
Milan, Italy	Science Museum		20th C.	L. da Vinci copies
Moscow, Russia	Bauman State Tech. Univ.	500	19th–20th C.	
Munich, Germany	Deutsches Museum	100	19th C.	Reuleaux
New York, USA	IBM	?	1950–1970	L. da Vinci copies
Newark, NJ, USA	Newark Museum	160	1930s	Clark/Brown
Paris, France	Musee des Arts et Meteir	?	19th C.	Schröder
Portugal	University of Porto	113	c. 1890	Reuleaux/Voigt
Prague	Technical University	23		Schröder
Riga, Latvia	Technical University	?		Schröder?
Rome, Italy	University	20		
Stockholm, Sweden	Science Museum		18th C.	Polhem
Tainan, Taiwan	Nat. Cheng Kung Univ.	c. 60		Japanese maker
Turin, Italy	University	?		
Vinci, Italy	Leonardo da Vinci Museum		20th C.	L. da Vinci copies
Zurich, Switzerland	ETH	10	c. 1880	Voigt/Reuleaux

Reuleaux. It is likely that Koch had purchased or merged with Schröder. A small collection of Schröder models exists at Cornell. Much larger collections may be seen at the Foundation for Science and Technology Museum in Florence as well as the University of Porto, Portugal (see Table II.5).

While Reuleaux's committee was awarding a medal in Philadelphia in 1876 to Schröder for models based on Reuleaux's books, Reuleaux had sent his own unique set of 300 kinematic models to England for an Exhibition of Scientific Apparatus at the former site of the London Exhibition of 1851, in South Kensington. A young Professor Alexander Kennedy (1876a,b), who that same year had translated Reuleaux's seminal work on kinematics of machines, wrote a glowing article in the London journal *Engineering* (Vol. 22, pp. 239–240) about both Reuleaux's models and his new book. It is odd that

the London Science Museum collection, which grew out of the 1876 exhibition, did not obtain the better Voigt copies of Reuleaux models but instead purchased some of the Schröder models. Most of the Science Museum models are in storage. However the museum has a collection of photographs of the Reuleaux model collection at the 1876 Kensington Exhibition.

Reuleaux's models were apparently influenced by a model collection of his former professor at Karlsruhe, F.J. Redtenbacher (see footnote 37 in Ferguson, 1977). Redtenbacher had published a catalog of some eighty models (*Bewegungs Mechanismen*, 1866), including complex clock escapement mechanisms that can be found in Reuleaux's later collection. When Reuleaux moved to Berlin he authorized a German Company, *Gustav Voigt, Mechanische Werkstatt*, to manufacture these models. Cornell's first President, Andrew Dickson White was ambassador to Germany in Berlin from 1879–1881 where he may have had a chance to see the Reuleaux models. In Reuleaux's letter to A.D. White in 1882, in English, he suggested that Voigt had worked for Reuleaux at the Gewerbe Institute in Berlin. Later Voigt won medals at several international exhibitions for his reproductions of the Reuleaux models. Reuleaux also said in this letter that he had designed the cast iron material with an alloy to prevent rust.

Several artist visitors to the Reuleaux collection at Cornell have described these models as kinematic sculpture. The sculptural aspects of these models are captured in part in the Color Plates in this book. The aesthetic quality of the design of the brass and iron is clearly shown in these images. Photos of the Reuleaux–Voigt models are presented in Part III of this book.

There were a number of competing model makers in Germany and France in the 19th century. The Voigt-Reuleaux models were unique in that they were designed to be used with Reuleaux's *Kinematics of Machinery* (1875–1876). This is clear from the engravings on many of the Voigt models with letters and numbers on the links and joints corresponding to figures in Reuleaux's book. The instructor was to use the models to illustrate kinematic inversions and expansion of machine elements as part of Reuleaux's theory of machine synthesis. This is clear from letters of Reuleaux to Henry Bovey, the Dean of Applied Science at McGill University. McGill had purchased a large set of Voigt models and Reuleaux implored the Dean to send someone to Berlin so that Reuleaux could show how to correctly use the models in the teaching of kinematics of machines. These letters (c. 1892) also show that Reuleaux was displeased with Cornell University because they did not have the faculty to properly use his models in teaching. The Cornell based textbook on kinematics by Barr and Wood (1916) for example, makes no mention of the kinematic

model collection at Cornell. On the other hand McGill professor R.J. Durley's textbook on kinematics (1907) shows many illustrations of kinematic models based on the McGill Collection.

A number of Voigt–Reuleaux models are of complete machines such as eight fully operating clock escapements and several complex speed transmission mechanisms. The clock escapements have as many as 15 moving parts, constructed from more than two dozen manufactured machine elements. Many of the simpler models are clearly designed for teaching. Some are demountable so that a different link can be fixed to obtain inversions. Many have adjustments to change link angles so the user can find the optimum setting, as in models for Hooke's or universal joints. The design of these Voigt reproductions, clearly show the aesthetic machine style of Reuleaux in the shapes of the pedestals. Drawings of similar shaped pedestals can be found in Reuleaux papers in the Deutsches Museum Archiv in Munich.

As mentioned above, several references to Reuleaux, mention a collection of Reuleaux models by Gustav Voigt at McGill University in Montreal. Copies of Reuleaux's letters to Professor Henry Bovey, Dean of Applied Science at McGill University in the Deutsches Museum Archiv show that over three hundred models were delivered to Montreal in the 1890s. However there is evidence in the *Gazette Montreal* newspaper archives (April 6, April 10, 1907) that the models were destroyed in a disastrous fire at McGill in 1907, which consumed the Macdonald Engineering Building where the collection was housed.

After Reuleaux's death in 1905, the Technical University of Berlin sent about 60 of his famed models to the newly opened Deutsches Museum in Munich. Records also show that Professor Wilhelm Hartmann, one of Reuleaux's students was the curator of the remaining model collection at Berlin. It is presumed that the bulk of the model collection at Berlin was destroyed during World War II. Today, about half of the original models in the Deutsches Museum are in storage and can only be seen by appointment.

THE REULEAUX KINEMATICS MODEL COLLECTION AT CORNELL

How Reuleaux's kinematic models reached the then small rural college of Cornell University in upstate New York is a curious story. The famed steam engine engineer, Robert H. Thurston of Stevens Institute was a member of the Scientific Commission of the United States to the Vienna International Exhibition of 1873, a decade before he came to Cornell. Thurston's report (1873) on the Vienna Exhibition of 1873, *Machinery and Manufactures, with an Account of European Manufacturing Districts*, mentions visiting Dr. Reuleaux

as director of the Gewerbe Institute in Berlin. Thurston mentions “*the fine collection of geometrical and mechanical apparatus*”. “*The models are lighter and neater than those usually seen in our own cases*” and that “*none are for sale*”. After Reuleaux exhibited 300 of his models at the 1876 Exhibition of Scientific Apparatus in London, he seems to have changed his mind about reproductions and by 1880 had engaged Voigt in the making of copies of his models.

There are documents in the Cornell University Archives that confirm that the collection was acquired in 1882 or thereafter. There is a letter in English (hand written) from Franz Reuleaux to President A.D. White dated 27th June 1882. This letter establishes that there was earlier correspondence between White and Reuleaux and that Reuleaux had supervised the shipping of the Voigt manufactured models to Ithaca. In this letter, Reuleaux also mentions his own heat treatment process to keep the cast iron models from rusting.

The minutes of the Cornell University Board of Trustees, June 14, 1882:

Acknowledges a pledge of \$8,000 from the Honorable Hiram Sibley of Rochester to secure the duplicate of the Reuleaux models in the possession of the Imperial Government of Germany.

(Hiram Sibley and Ezra Cornell both formed the Western Union Telegraph Company in 1855.)

It is likely that Reuleaux met both White and Thurston in Philadelphia at the 1876 Centennial Exhibition where they were on judging panels together. The Cornell Archives of A.D. White, show that White traveled to Europe in the fall of 1876. It is possible he may have seen the Reuleaux models at the Exhibition South Kensington. White was also American ambassador to Berlin from 1879–1881, and may have seen the Reuleaux models in Berlin. Later when he returned to Cornell, White wrote a paper on the German educational system and praised the technical education represented at the new Berlin Technical University where Reuleaux was professor and later rector.

There is a wonderful little book by Professor A.B.W. Kennedy of University College, London with a 19 page introduction by Robert H. Thurston (Kennedy 1881). The book title is *The Kinematics of Machinery: Two Lectures Relating to Reuleaux Methods*. These lectures (88 pages), were given by Kennedy at the South Kensington Museum. Kennedy described Reuleaux’s theory of kinematic pairs and his symbol representation of complex mechanisms. This small book illustrates the high esteem in which Reuleaux was held both in Europe and the U.S. and the relation of his theory to his models. (Kennedy later became the President of the Institute of Mechanical Engineers in Great Britain and Thurston became the first president of the Ameri-

can Society of Mechanical Engineers (ASME). Kennedy mentioned the loan to the Museum of 300 models of the Kinematic Collection of the Gewerbe Akademie in Berlin, designed by Reuleaux. He also mentioned a set of models at Dresden as being essentially the same as the Berlin models. Two years after Reuleaux's death there appeared an article in *Scientific American* about his model collection with photographs of 11 of the models (see Gradenwitz, 1908).

There was a tradition in the early history of mechanical engineering of extensive use of kinematic and dynamic models to illustrate the new mathematical underpinning of engineering science. The late historian at the University of Delaware, Eugene Ferguson (1977, 1992), posited a thesis that visual knowledge, embodied in illustrations and three-dimensional models, were important methods of communicating scientific and technical information from the Renaissance to the age of computers. In many areas of engineering education today the use of physical models has almost disappeared. Although Willis and Reuleaux had advanced machine design through the use of mathematics, they followed the earlier tradition of the use of demonstration models in the teaching of machine theory and design. The spread of their teaching models as well as their books around the world shows the beginnings of a globalization of engineering science at the last quarter of the 19th century.

Many of these model collections were destroyed in World War II or discarded in the computer modernization of the 1960s and 1970s. Today a number of universities and museums have discovered both the historic and educational value of physical mechanical models and have restored these treasures. Large collections of kinematic models can be found at the technical universities in Aachen, Dresden and Moscow. Large collections of Reuleaux–Voigt models can be found at Cornell University in upstate New York, Porto, Portugal and the Deutsches Museum in Munich. Large collections of Schröder models can be found at Porto and the Foundation for Science and Technology in Florence. A large collection of American made models circa 1930, are in the Boston museum of Science and the Newark Museum (in storage) in New Jersey. There is a small collection of Reuleaux–Voigt models in the University Museum in Kyoto as well as Japanese-made copies of kinematic models at the university in Tainan, Taiwan. A list of model collections can be found in Table II.5.

There was a progression of engineering knowledge codification from workshop secrets in the Middle Ages to graphical representation in the manuscripts of the Renaissance engineers, Taccola, Francesco di Giorgio, and

Leonardo and on into the ‘theatre of machines’ books of Besson, Ramelli and Strada, Leupold and many others into the 18th century. The ‘Theatre’ books were eventually displaced by math and science-based textbooks as well as pedagogical machine models in the 19th century. These models have since been eclipsed in the late 20th century by mathematical and computer software Computer Aided Drawing (CAD) models.

Recent research on learning and the brain have suggested that the operations of the brain cannot be explained with an algorithmic model of lists of instructions as in the modern computer. Studies on mathematical learning, such as spatial perception, motor skills and walking, all point to the interaction of the brain with physical dynamics of the body connected to the brain. Some educators now believe that physical hand sketching is important in developing three-dimensional perception and that using the compass and protractor to work on geometry exercises is helpful to the understanding of mathematics. Some engineering design faculty have begun to recognize the importance of not only freehand drawing but of using and building models of machines and engineering artifacts to develop the creative skills of prospective engineers.

THREE-DIMENSIONAL PRINTING OF HISTORIC MODELS OF MECHANISMS AND MACHINES

How does one preserve historic machine models and at the same time encourage students to play with three-dimensional physical models to help develop their kinematic intuition? One solution is to have the students use CAD software to construct a virtual model of the machine. Recently faculty at Cornell University have used rapid prototyping technology to ‘print’ out three-dimensional plastic models of kinematic mechanisms of historic and current interest (Lipson et al., 2005).

To document the 19th century Cornell Reuleaux models, CAD drawings of several mechanisms were made. The three-dimensional drawings were then converted into stereolithography (STL) format files. This format maps surfaces into a mesh of triangles, which can be used as input to rapid prototyping software for a three-dimensional printer (see Lipson et al., 2005).

Two methods of rapid prototyping technology have been used; a multi-layer technique for three-dimensional mechanisms and laser cutter technology for two-dimensional mechanisms. A rapid prototyping technology, called fused deposition modeling or FDM, was used at Cornell to reproduce three-dimensional models of several Reuleaux–Voigt kinematic models. The system is manufactured by Stratasys (Model FDM 2000). The process creates a sequence of thermoplastic layers from a filament wound coil that is heated

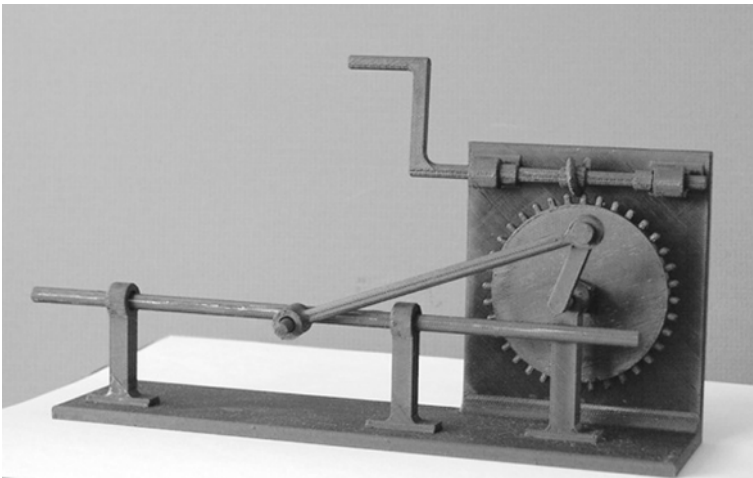
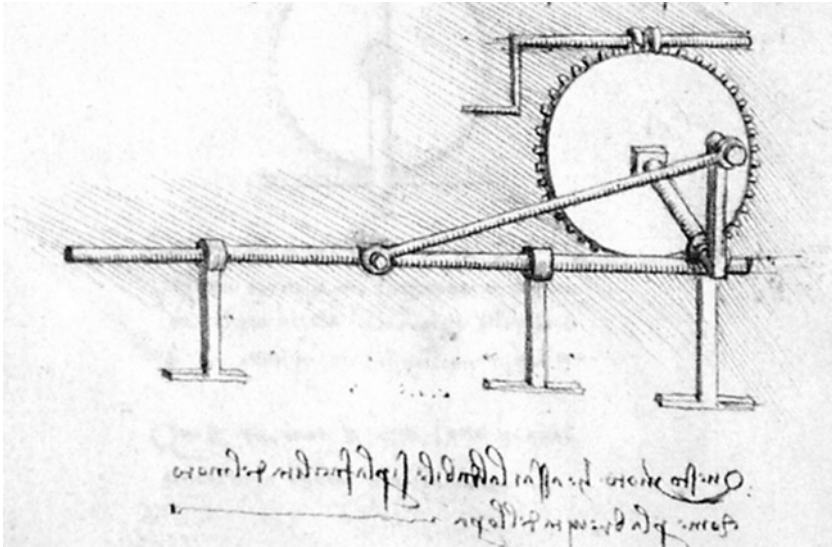

Figure II.26. Rapid prototype models of historic machines (Lipson et al., 2005). Top: Worm gear and slider-crank mechanism of Leonardo da Vinci (*Codex Madrid*); Bottom: Rapid prototype 'printed' model

and extruded through a nozzle. The x - y planar location of the nozzle is controlled by information from the stereolithography file of the CAD model. In order to create functioning mechanisms, a second, water soluble release material is placed in the gaps between the movable parts. This system has been developed by Professor Hod Lipson of Cornell University.

The FDM produced copies of the Reuleaux models are remarkably visually true to the originals (see KMODDL for a comparison). The models are fairly robust to use and move. The cost to produce one is a fraction of that necessary to manufacture a traditional copy in iron and brass. The time to complete a model from the CAD code is fairly long. A half scale model of the slider-crank took approximately 6 hours in the FDM machine. Complicated clock escapement and a tens-carry mechanism for a 19th century arithmometer have also been printed in plastic (see Moon and Lipson, 2007). Recently Hod Lipson at Cornell has developed a faster laser cutting rapid prototype method of producing kinematic models.

An example of a CAD printed kinematic model is one made after Leonardo da Vinci of a worm gear and slider-crank mechanism. The original sketch and the working model are shown in Figure II.26.

II.14 JAMES WATT AND THE STEAM ENGINE: PATHWAYS OF MACHINE EVOLUTION

Robert H. Thurston [1839–1903] was the American counterpart to Franz Reuleaux; he was an academic engineer with considerable practical experience who advocated an engineering science approach to technical education. Thurston first taught at Stevens Institute of Technology in Hoboken, New Jersey in 1871. There he developed material testing laboratories and published an important treatise on materials engineering. He also invented an automatic stress-strain testing machine. In 1873 he was appointed ambassador to the International Exhibition in Vienna. In his report to the US State Department, he mentioned a visit to Professor Reuleaux in Berlin and commented on the teaching models there. In 1885, Andrew D. White, the President of Cornell University, persuaded Thurston to come to Ithaca and reorganize the College of Mechanical Engineering. In contrast to Reuleaux's focus on kinematics of machines, Thurston's interest in machine design was on materials and thermodynamics, especially as they impacted the steam engine. As much as he admired theory and mathematics, Thurston was a firm believer in the evolution of technology. In his well-known treatise, *A History of the Growth of the Steam Engine* (1878). Thurston wrote:

I propose to call attention to the fact that the history [of the steam engine] illustrates the very important truth: *Great inventions are never, and great discoveries are seldom, the work of any one mind.* Every great invention is really either the aggregation of minor inventions or the final step of a progression. It is not a creation, but a growth – as truly as is that of the trees of the forest.

In his *History* Thurston recited a litany of earlier contributors and inventors that made the steam engine possible. He began with the ancient Greeks – Hero's *aeolipile*, a rotating sphere with two arms expelling steam. He recognized the contributors in the Renaissance; Leonardo for his 'steam cannon' or *architonnerre*, and a Spaniard named Blasco de Garay [c. 1543], the Italian Giovanni Battista della Porta [c. 1601], and the French machine book author Salomon de Caus (1615). From England Thurston named Edward Somerset, Marquis of Worcester [c. 1663], and from the Netherlands Christian Huygens [c. 1680] who proposed a gunpowder engine and the Englishman Sir Robert Moray, who was Master Mechanic to the King, and measured the pressure-volume properties of steam.

Thurston's litany of working steam engines began with Thomas Savery [c. 1698], Denys Papin [c. 1687], and finally the blacksmith from Dartmouth

England, Thomas Newcomen [c. 1705] whose machine concept had a life of over 75 years before the major contributions of James Watt. Thurston defined the steam engines of Newcomen and later engineers as engines with a train of mechanisms; Newcomen he said,

had finally effected a combination of the elements of the modern steam-engine, and produced a machine which is unmistakably a true engine – i.e., a train of mechanism consisting of several elementary pieces combined in a train capable of transmitting a force applied at one end and of communicating it to the resistance to be overcome at the other end –

These new practical machines were considerably more complex in the variety of machine elements and kinematic mechanisms than the simple cylinder and piston of Leonardo da Vinci or the spherical vessel and cock valve of Salomon de Caus. The steam engines of Newcomen, Boulton and Watt and later engineers employed slider-crank and eccentric mechanisms, planet-sun epicycloid gear trains, straight-line linkages, flywheel and rotating ball speed regulators as well as complex valve control linkages. This complexity increased further when the steam engine was employed as locomotives for railroad transportation as in Stephenson's reversing linkage. (As a note, Reuleaux (1876b) in one of his research papers described an experimental device to measure the effective inertia of rotating ball regulators for steam engines.)

The Leonardo scholar, Ladislao Reti (1969) posited a theory claiming that Leonardo's rough sketches on steam power later influenced Salomon de Caus (1615) in his demonstration of a steam pump as well as Giovanni Branca's design (1629) for a steam impulse turbine. Assuming these assertions are correct, Reti then argued for Leonardo's direct influence in the lineage to Newcomen and Watt's machines. However, the sketches Reti cited are not Leonardo's clearest and are not very detailed. Reti assumed that de Caus and Branca had access to Leonardo's manuscripts a century after Leonardo's death, which might have been possible. Here one must be skeptical since there were several thousands of folios, with no index or guide, and it is unlikely that de Caus and Branca could have stumbled on these small sketches and copied Leonardo's ideas about steam power. Hart (1961) also voiced this skepticism in his mechanical studies of Leonardo. It shows the continuing effort to anoint a 'genius', such as Leonardo da Vinci, with the key inventions of the industrial world, when it is likely that Leonardo played a small part in the evolution of steam power.

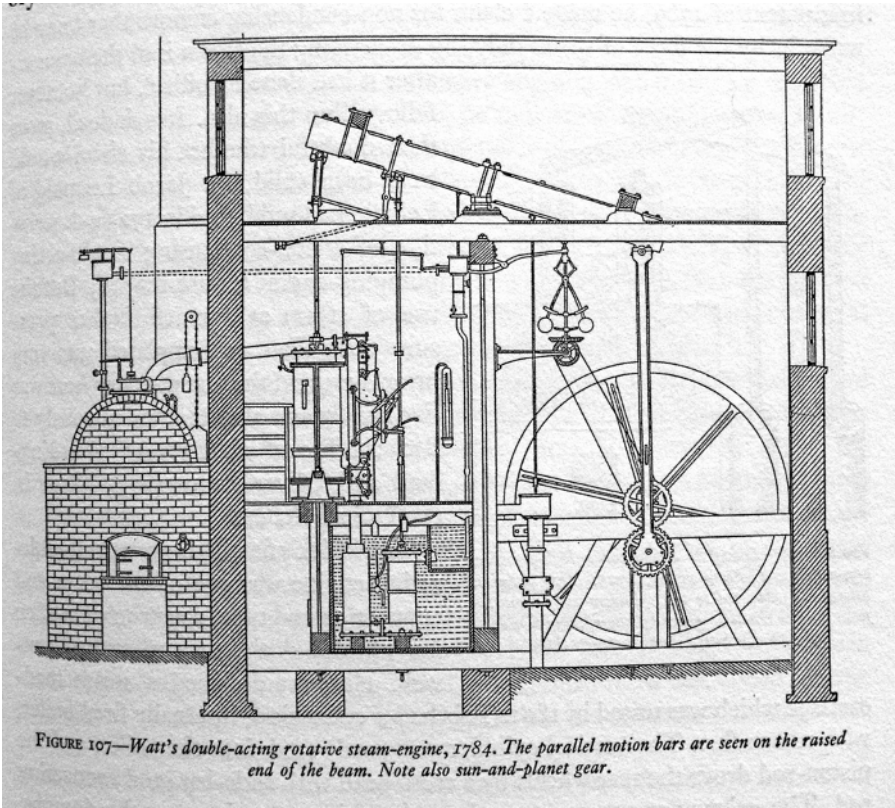

Figure II.27. Sketch of steam engine components of James Watt, 1784

The many variations of the steam engine in the 19th century spawned many technical reviews and historical books. Two early histories were one by Farey (1827) and Lardner (1827, 1836). Up until the mid 20th century, it was common to recant the many inventors who had contributed to the development of the steam engine, but this tradition has disappeared in modern technical books on machines.

The steam engine as an example of machine evolution is a prime illustration of the five conditions necessary for invention of a useful machine listed in Section II.1. Here we formally discuss each of them noting the context in which James Watt brought together existing knowledge as well as his own inventions and created a machine that revolutionized the 19th century.

THE FIVE CONDITIONS FOR INVENTING A USEFUL MACHINE

(i) *A tradition of building machines*

Although many popular books claim that James Watt invented the steam engine, the roots of the machine can be traced into the Renaissance. We know, for example, that Leonardo had designed an experiment to measure the expansion of steam, even drawing a cylinder and piston topology. As described in Thurston's book, Leonardo also proposed a 'steam cannon' (Ms. B., Folio 33r). In the 17th century, Otto van Guericke used an air pump to demonstrate the power of air pressure and a vacuum in his famous drawings of men and horses trying to separate two halves of hemispheres holding a vacuum inside. In the same century, Evangelista Torricelli [1608–1647], a student of Galileo, measured the atmospheric pressure of air at 30 inches of mercury. In 1690, Denys Papin built a cylinder and a piston and used heat to raise the piston, demonstrating the potential for creating mechanical work from heat. In a patent of 1698, Thomas Savery created a vacuum device to raise water out of mines. Papin in 1705 modified Savery's machine using a moving piston. Finally, Newcomen, in an apparently independent invention of 1712, invented a so-called 'atmospheric steam engine' that created a vacuum below a piston in a cylinder that worked on a lever lifting a water pump. The principal application of this machine was in the deep Cornish mines in southwest England. Between 1712 and 1763, dozens of such steam engines were built until Watt improved the horribly poor efficiency of Newcomen's machines. Thus Watt and Boulton inherited a long tradition of steam engine building experience.

(ii) *A cadre of craftspeople with technical skills*

One of the contributions of the Middle Ages, was the development of trade guilds and other crafts skills that passed on valuable technical knowledge across generations and across Europe (see Section II.6). One of those trade lineages is that of instrument maker. Both Watt's father and grandfather had learned this skill, repairing instruments of navigation such as compasses, surveying instruments and perhaps even some clocks. Such skills demanded precise measurements and a rudimentary knowledge of mathematics was necessary. James Watt [1736–1819], born in a small seaside village of Greenock east of Glasgow, Scotland, also learned these skills and practiced them in both Glasgow and London. He eventually obtained a position at the University of Glasgow, as a mathematical instrument maker. His repair of a working model of Newcomen's steam engine at the University in 1763 is legendary as well as his frustration of finding funds to build a full-scale

machine to test his ideas.

(iii) *A supply of capital*

Watt's first patent of 1769 initially attracted the manufacturer, Roebuck who owned an iron works. After problems with Roebuck and much negotiation, Watt joined Matthew Boulton, who owned a factory manufacturing toys and trinkets. Boulton convinced him to become partners in building Watt's new steam engines that were five times more efficient as the Newcomen machines. Boulton not only provided the cash but also an existing skilled work environment, in his Soho Manufactory north of Birmingham with modern machine tools and a watermill source of power. Thus water power was used to create steam power that would soon replace the former. Boulton also convinced Parliament to issue an exclusive patent, valid until 1800, which eliminated competition. This patent gave Watt time to develop the next generation machines that could not only pump water out of mines but could convert the oscillating motion of the piston into rotary motion of a flywheel whose energy would drive the machines of a factory. This patent of 1781, led to the sun and planet epicycloid kinematic gear mechanism, as well as the 'straight-line' linkage that allowed the piston to remain vertical and act in a push-pull operation leading to the double acting steam engine. During this period, Watt also obtained another patent for his rotating ball speed control valve mechanism, one of the first control systems of the modern industrial era.

(iv) *A society with a spirit of progress*

In a recent book, *The Lunar Men*, Jenny Uglow (2002) describes an association of men including Josiah Wedgwood, Joseph Priestly, and Mathew Boulton, who met on the night of the full moon near Birmingham to discuss new ideas in science, technology and politics. This group had connections to Benjamin Franklin, who was in Europe at the time, and eventually brought in James Watt into their circle. The focus of these men was on new ideas. This belief in the march of progress had its roots in the late Middle Ages.

Up until the 13th century, the Christian European's view of the world was as a temporary way station on the way to purgatory, heaven or hell. In the age of the Schoolmen of the church schools of the 13th century, scholars such as Roger Bacon argued that improving the world was also part of God's plan and obtaining knowledge of the world, i.e., science, as well as inventing new machines, was not contrary to God's laws. Mankind had an obligation to learn and improve the world in which he lived. This idea spawned the *concept of*

material progress that accelerated five centuries later in the 18th century of Newcomen, Watt and Boulton.

Although Watt's grandfather was not university trained, he founded a school to teach navigation and mathematics with the belief that knowledge of the latter was necessary to advance a seaman's career. Concomitant with a spirit of progress is recognition of the *importance of education*. It is of interest that the seeds of the Industrial Revolution did not come from London, or Oxford or Cambridge but from the industrial region of Birmingham and Glasgow. It was not the knowledge of the humanities alone, but the ideas of science, mathematics and technology that flourished together in these communities that nourished the invention of new revolutionary machines.

(v) An inventor, motivated to challenge the status quo

The Newcomen engine enjoyed a singular position for half a century before Watt challenged the basic premise of its operation. Certainly there were technically skilled instrument makers who had tinkered with models of steam engines other than James Watt. It must have been obvious to some clever engineer that energy was lost every time the piston was cooled each cycle of the pumping action. One explanation for Watt's success was the position he enjoyed at the University of Glasgow, especially working with Professor Joseph Black who had discovered the latent heat of steam. Perhaps Watt implicitly or explicitly applied some of Black's thermodynamic ideas to his new machine.

As a young man there was something in Watt's character that led him to leave the small community of Greenock and try to make a living in Glasgow, then move to London, which was not especially hospitable to Scotsmen, and to try to make his career by himself there. On his return to Glasgow he had transformed himself into a civil engineer working as a surveyor, mapping out a route for a new canal. Both Leonardo and Watt were immersed in a community of technical colleagues, but had dreams that surpassed their contemporaries. Both were able to become expert in more than one field. Both came from families that were unstable and both had to struggle early in life. The genius does not exist in a vacuum, is not necessarily a loner, as he or she must absorb the traditions of knowledge and culture that laid the foundation for new advances.

There are several other factors that contributed to the invention and development of the steam engine in England and Scotland in the 18th century, such as the existence of deep mines and the need to pump out water. Also the development of iron manufacturing created a need for blowers powered by the steam engine. There were also many other contributors than those in the litany

recited above, such as Oliver Evans [1755–1819] of the United States. At the end of the 18th century there were almost no steam engines in North America. Two low-pressure Watt type engines were installed in the Philadelphia water works designed by an engineer trained in England. Evans was trained as a wheelwright and then operated a mill supply store. In industrially underdeveloped America, with minimal contact with steam technology, Oliver Evans invented a high-pressure steam engine that went beyond both Newcomen's and Watt's atmospheric machines. Evans also envisioned a steam engine actuated wheeled vehicle, but lacked the capital to carry out these ideas. Evans wrote a handbook on steam engines in 1805 titled, *The Young Steam Engineer's Guide*. In this book he praised the power of steam:

Of all the principles of Nature, which man by his ingenuity has yet been able to apply as a powerful agent to aid him in the attainment of a comfortable subsistence, Steam, produced by boiling water, will perhaps soon be esteemed first in the class of the most useful for working all kinds of mills, pump, and other machinery, great and small.

In the opening paragraphs of his book, Evans advertised the applications for which the steam engine could be used, including driving mill stones, sawing timber, pumping water, pressing juice out of sugar cane, in rolling mills, driving a forge hammer or a furnace bellows, propelling a boat or driving a land carriage with a heavy burden. With such optimistic prospects, Evans encouraged those interested in procuring such an engine to contact the inventor-patentee, lest they infringe on his right granted to him by an act of Congress. With such a small foothold in the Americas, steam engine technology was poised to drive this new civilization to the forefront of machine technology in less than a few decades.

In their book on the foundations of modern Europe, Rice and Grafton (1994) cite three factors in the rise of science; (i) a study of logic by the scholastics in Paris and Oxford of the 14th century, (ii) the emergence of experimentation, as in the work of Leonardo da Vinci, and (iii) the development of mathematical knowledge, especially the work of Newton and Leibniz in the 17th century. On this last point, the importance of mechanics, mathematics, physics and chemistry in machine invention and design emerges clearly in the development of the steam engine. Beginning with Leonardo there is the study of the expansion of water into steam. Salomon de Caus was an engineer and architect, likely skilled in mathematics. Savory was a military engineer who had studied mechanics, physics and mathematics. Denys Papin studied medicine, mathematics and physics. Another contributor was

Smeaton [1724–1792], who before Watt's machines were in practice, scientifically studied Newcomen's engines and was able to double the efficiency. Newcomen was the exception as a skilled ironworker. As noted earlier, Watt was a skilled instrument maker and later surveyor who had to have skills in mathematics. He also worked with the physicist Joseph Black at Glasgow and performed many scientific experiments himself. The steam engine of the 18th and 19th centuries was not possible without scientific concepts of liquid and gaseous phases of water, pressure-volume properties of steam, the concept of a vacuum, heat, temperature, energy and power. As science influenced the invention of steam machines in the 18th century, one can also say that it was the steam engine that helped bring about modern theories of thermodynamics in the late 19th century.

This complexity in the kinematic nature of the steam engine, its increasing dependence on physics and a mathematical understanding of forces and stresses within the machine, brought into being the engineer-scientist especially in Germany and with it the beginning of specialization of machine design that has continued unabated today.

REULEAUX ON WATT

It is difficult for those of us in the 21st century to imagine the fascination that steam power had on the imagination of 19th century Europe and America. As illustrated in the quotes from Oliver Evans, the possibilities of steam technology inspired an optimism about machines that is largely lacking today. Readers today cannot appreciate the adulation and respect for James Watt that existed during the industrial age. Many biographies were written about Watt including one by the industrialist Andrew Carnegie (1905). In a monument in London's Westminster Abbey, is a plaque with the text:

JAMES WATT, Who, directing the force of his original genius, early exercised in philosophic research, to the improvement of THE STEAM ENGINE, Enlarged the resources of his country, increased the power of man, and rose to an eminent place among the most illustrious followers of science and the real benefactors of the world.

Perhaps the closest technologist today with universal recognition is Bill Gates, who in spite of his generosity with his billions will likely not garner such praise as James Watt when he passes on.

The network connection from Watt's steam engine to Reuleaux's family is fairly direct. Both Reuleaux's father and grandfather built some of the first steam engine mine pumps in Europe, in the Belgium city of Liege. Before

Franz Reuleaux was born, his father moved the factory to the then French city of Aix la Chappell. After the defeat of Napoleon, the city became the West Prussian town of Aachen. Steam technology diffused to Europe by way of Belgium, first because Belgium had deep mines that required heavy pumping machines and second because the English did not trust the French with their technical secrets. Whether the Reuleaux factory was licensed by Watt and Boulton, before the end of their patent protection, is not known.

Franz Reuleaux's personal interest in Watt arose from his fundamental interest in the nature of invention. In the opening pages of his famous book, *Kinematics of Machinery* (1876), Reuleaux posed the question of how new machine mechanisms came to the mind of the inventor. At the beginning of his book Reuleaux quoted a letter that Watt wrote to his business partner Boulton on his invention of a straight-line mechanism to keep the piston aligned to the vertical:

I have got a glimpse of a method causing a piston-rod to move up and down perpendicular by only fixing it to a piece of iron upon the beam, without chains, or perpendicular guides, or untowardly functions, arch heads, or other pieces of clumsiness, — and it will answer for double engines as well as single ones. I have only tried it in a slight model yet, so cannot build upon it, though I think it a very probable thing to succeed, and one of the most ingenious pieces of mechanism I have contrived, —

Clearly Watt was very excited about his new mechanism and especially the simplicity of its function; 'without other pieces of clumsiness'. Years later in a letter to his son, again quoted by Reuleaux, Watt described, using a geometric diagram based on two circular arcs, how he had come to invent this four-bar, approximate, straight-line mechanism.

Though I am not over anxious after fame, yet I am more proud of the parallel motion than of any other invention I have ever made.

Indeed many other inventors also thought that this particular part of Watt's engine was as important as the condenser and sought for over 80 years to invent similar straight-line linkages.

Reuleaux however expressed his frustration at having no real insight into Watt's thinking about his invention. Reuleaux wrote that he was glad to "*overhear the Genius in his thought workshop*". Reuleaux added:

We quite appreciate the motives as well as some of the final results of Watt's exertions, but we obtain no indication of a methodical train of ideas leading up to them.

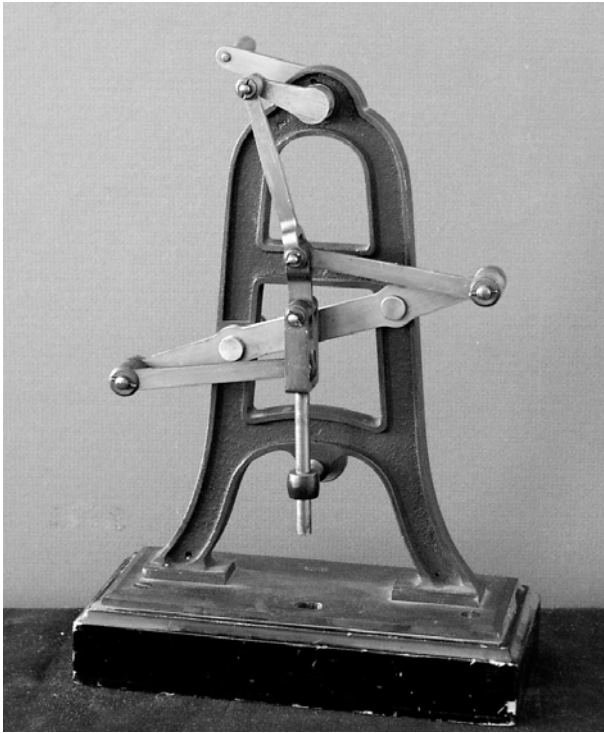

Figure II.28. Reuleaux–Voigt model of a Watt straight-line mechanism (Cornell University Collection of Kinematic Models)

Watt’s straight-line mechanism of which he was most proud also impressed Reuleaux and other mechanism designers and mathematicians in the 19th century such as the Russian mathematician, Chebyshev. Reuleaux in fact designed 29 models of straight-line mechanisms, including two related to the invention of James Watt (Figure II.28). Further discussion of the straight-line mechanism can be found below in Section II.17.

The need to cite the litany of contributions and inventors of steam engine technology was quite wide and can be found in many technical books such as Farey (1827). Franz Reuleaux himself wrote a short essay on the history of the steam engine and his contemporary, Robert Thurston (1878) wrote an entire book on the subject.

As widespread the acclaim for the marvels of the steam engine in the late 19th century were, the seeds of its demise and disappearance by the turn of the century became evident with the introduction of the gas engines of Otto and Diesel, the appearance of the multi-stage steam turbine of Parsons and with the development of the electric motor spurred on by Reuleaux’s own Berlin

colleague, Siemens, and the invention of the electric light bulb by Edison. Rarely does one find a reference in Reuleaux's writings about the challenge of these new energy technologies to the steam engine. Likewise a century earlier James Watt clung to his atmospheric engine until the end of his patent when many other steam engine concepts began to appear such as the high pressure engine and the horizontal engine.

Returning to Robert Thurston's history of the steam engine, in his 1905 edition he devoted very few pages, out of this 530-page treatise, to the steam turbine, gas engine and the electric motor. On the steam turbine he referenced the 1840 machine of Atwater. He briefly discussed the Dow turbine (c. 1881) which was designed for a torpedo application generating 11 horsepower at 60 psi steam pressure and a flywheel speed of 10,000 RPM. At approximately the same time, Parsons introduced a multi-stage steam turbine for use in electrical generation, with turbine speeds up to 20,000 RPM. On the gas engine based on the Otto cycle, Thurston wrote at the end of his book;

since theory shows that it is possible to increase the efficiency of the actual gas engine two or even threefold, the conclusion seems to be irresistible that gas engines will ultimately supercede the steam engine.

Having been extremely prescient on the future of the gas engine, it is odd that Thurston devoted so little discussion to its study. Reuleaux, who had helped Otto and Langen with the development of their gas engine, also did not devote any space in his books to this revolutionary prime mover. These examples of technical intransigence are not isolated. The Wright brothers stuck with the bi-plane design long after others such as Glenn Curtiss used the single wing concept. Edison pushed the direct-current distribution system until the alternating current system took over. These inventor-engineers spent part of their lifetimes pushing the boundaries of technology until each was bypassed by a new generation.

Having begun with a Thurston quote on steam, we end this section with another illustrating steam's intellectual hold on the imagination of late 19th century engineers;

As Religion has always been, and still is, the great *moral* agent in civilizing the world, and as Science is the great *intellectual* promoter of civilization, so the Steam-Engine is, in modern times, the most important *physical* agent in that great work.

II.15 MACHINE ENGINEERS AND INVENTORS IN THE 19TH CENTURY

The ‘age of machines’ spanned Watt’s remarkable improvements to the steam engine in the last quarter of the 18th century to the Wrights’ development of powered flight at the beginning of the 20th century. In the early 19th century, machine technology was a workshop process passed on to apprentices by master mechanics and engineers who often kept their methods secret and guarded against use by their competitors. The steam engine not only sparked a revolution in the creation of a mobile energy source, but also resulted in the evolution of new methods of creating machines. The wresting of machine design from the workshop began in the Ecole Polytechnique in Paris in the late 18th century with the work of Monge and Hachette, and later by Ampere and Lanz and Betancourt. These ideas were further developed in Britain, especially in the work of Robert Willis [1800–1875] and William Rankine [1820–1872] and in Germany by Ferdinand Redtenbacher [1809–1863] of the Polytechnic School at Karlsruhe whose student was Franz Reuleaux [1829–1905].

The workshop system in Britain during the early machine age was characterized by a close relationship between master mechanics and young engineers through apprenticeships. For example, Henry Maudslay [1771–1831] trained with a lock manufacturer Joseph Bramah [1749–1814] who invented the hydraulic press. Maudslay also worked with the great civil engineer Sir Marc I. Brunel [1769–1849]. Maudslay later trained engineers and tool-makers Joseph Whitworth [1803–1887], James Nasmyth [1808–1890], and Joseph Clement [b. 1779]. Clement was hired in the 1820s to build Charles Babbage’s famous kinematic calculating machine. What all of these great engineers had in common was a lack of formal engineering training. This training of machine designers and builders was not too different from the training of the Renaissance engineers such as Mariano Taccola, Francesco di Giorgio, Filippo Brunelleschi and Leonardo da Vinci.

On the other hand the 19th century, machine theorist Robert Willis [1800–1875], educated in the mathematics tripos at Cambridge University, clearly came from a different pedigree than most engineers of his generation (Figure II.29). (See Moon, 2003, for a short biography of Robert Willis.) Willis was elected as a Fellow of the Royal Society in 1830, and taught at Cambridge at the same time as the mathematician Charles Babbage, who designed the forerunner of the computer. Willis made drawings in his personal sketchbook of Babbage’s famous ‘difference machine’ calculator (Figure II.29a). Franz Reuleaux came from a family engineering workshop tradition in Bel-

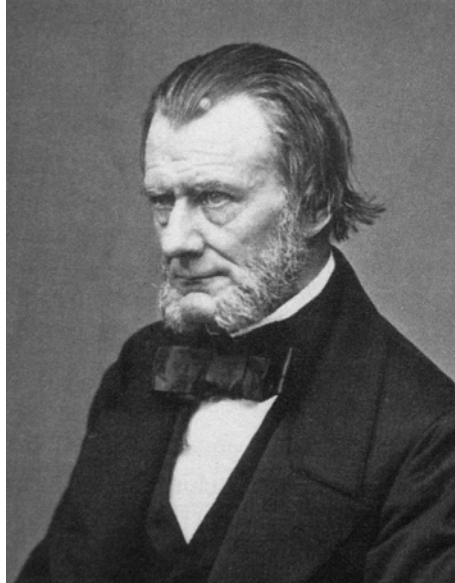

Figure II.29a. Robert Willis p[1800–1875] Professor, Cambridge University. Forerunner of rational machine design. (Photo, Royal Society of London)

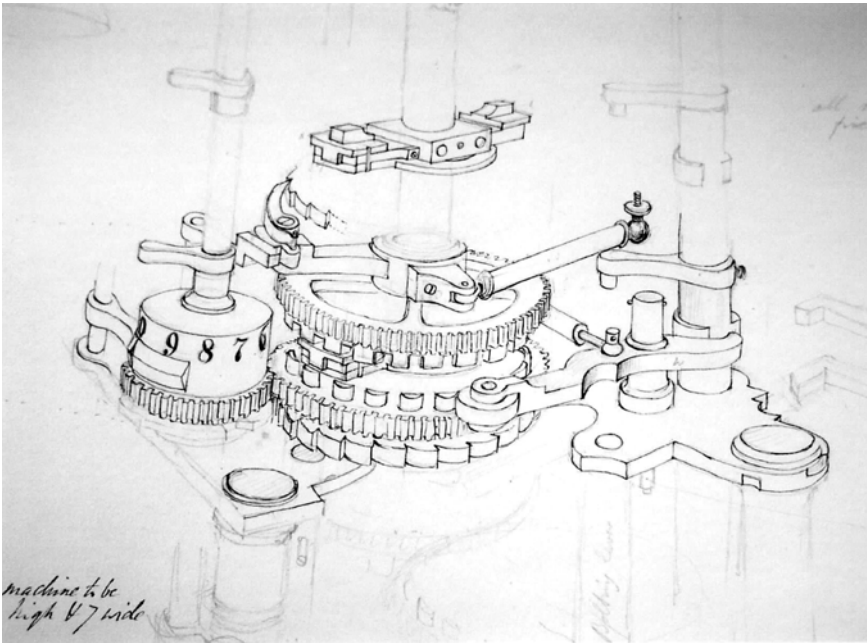

Figure II.29b. Drawing of Willis of mechanism for Babbage's Difference Machine calculator. (Courtesy, Cambridge Univ. Engineering Library)

gium that made machines and pumps. He broke that mold by obtaining his engineering education at the universities at Karlsruhe, Berlin and Bonn based on mathematics, science and philosophy.

The *Machine Age* of the late 18th and 19th century often brings to mind the names of the great inventors and machine builders such as James Watt, Isambard Brunel, Robert Fulton, William McCormack, Werner von Siemens, Karl Benz and Orville and Wilbur Wright. The names of *theoretical* engineers such as Robert Willis of Cambridge, William Rankine, Ferdinand Redtenbacher and Franz Reuleaux are unknown to most historians of science and technology, let alone to the lay public. Yet it was these individuals that codified the design of machines that enabled this knowledge to propagate throughout the science-educated world.

It is interesting to compare the influence of Great Britain's academic engineers in industry in Great Britain with Reuleaux and his counterparts in Germany thirty years later. Robert Willis of Cambridge University belonged to a cohort of engineers who contributed much to the advancement of the machine age (Figure II.29a). He wrote a very influential book on the kinematics of machines in 1841 that impressed not only men like Rankine but also many French academic engineers. He likely had some direct or indirect influence on Charles Babbage mechanical computer designs since Babbage was a professor at Cambridge at the same time as Willis (see Figure II.29b).

Among the great British engineers of the day were I.K. Brunel [1806–1859] who built major rail and bridge facilities as well as three of the greatest steamships of the time, Joseph Whitworth [1803–1887] who standardized machine elements, and James Nasmyth [1808–1890] who developed high precision machining techniques. Yet in the biographical sources of these men, there is no mention of any interaction with Robert Willis, whose lectures and books had placed him in the forefront of engineering theory. In England and Scotland practical engineers were trained through an apprenticeship system and not in engineering schools. Brunel's famous father, Sir Marc I. Brunel tried to groom his son for admission to the l'Ecole Polytechnique in Paris, but Isambard K. did not pass the competitive exam and instead served his apprenticeship with a famous horologist, Louis Breguet, in Paris. The contrast with the situation in Germany a generation later could not have been greater.

Reuleaux received formal education at the Polytechnischen Schule at Karlsruhe under Ferdinand Redtenbacher, as well as practical training in his uncle's company. Carl Benz [1844–1929] also received his training from Redtenbacher, as did Eugen Langen who with Nicholas Otto developed the internal combustion engine. Langen and Reuleaux were classmates at



Figure II.30. Professor Ferdinand Redtenbacher [1809–1863], Teacher of Franz Reuleaux, Eugen Langen and Karl Benz; Karlsruhe Polytechnic School, Germany

Karlsruhe and Reuleaux played a pivotal role in the early development of the Langen-Otto enterprise. Redtenbacher is known as a pioneer in Germany's development of mechanical engineering education.

In Reuleaux's line, the Mannesmann brothers were his students and Reuleaux played a key role in the development of their seamless pipe manufacturing, serving at one time on the board of trustees of their British subsidiary. Other students of Reuleaux at the technical university of Berlin at the time were Otto Lilienthal a pioneer of aviation, Carl Linde, who developed refrigeration and Hugo Junkers of aircraft fame in the early 20th century. By the end of the century, the route of professional education of many famous German engineers started in the university with a background of mathematics and engineering science as well as practical training. Some historians have attributed the adoption of engineering science education in Germany as one of the reasons that Germany overtook Great Britain industrially by the end of the 19th century. In contrast, in spite of Willis' fame abroad, Cambridge University did not establish an engineering tripos until 1875, the year of Willis' death. (See Mauersberger, 1989, for a discussion of German engineering education in the 19th century.)

WORKSHOP VERSUS ENGINEERING-SCIENCE BASED EDUCATION

The tension between workshop and science based education of engineers was played out in the United States at Cornell University, some of whose profes-

sors were among the early presidents of the American Society of Mechanical Engineering (ASME) (Calvert, 1967). Two of these men, Robert H. Thurston and John E. Sweet represented the science versus shop approaches. Cornell was founded in 1865 as a Land Grant University in Ithaca New York, whose mission was to teach agricultural and mechanic-arts alongside the traditional, humanities and sciences. The University's namesake, Ezra Cornell, was a partner with Samuel Morse in establishing the first telegraph system in the United States. Sweet as one of the early professors, established a shop-based curriculum for mostly farm-raised boys and produced a number of successful graduates who went on to start their own companies building machines. In the late 1870s tension built between the faculty as to the nature of 'mechanics arts' in a university and eventually John Sweet left Cornell to start his own company in Syracuse, NY.

Cornell's first president, Andrew D. White, who had served as US ambassador in Berlin, 1879–1880 and had likely met Franz Reuleaux, returned to Cornell and sought advice from Professor Robert Thurston who at the time was at Stevens Institute of Technology in New Jersey. Thurston had also been a US representative to the Vienna Exposition in 1873 and met Reuleaux in Berlin. Thurston advocated a math and science based curriculum and recommended that the College take the name Mechanical Engineering and Mechanic Arts. It was White's negotiation skills that convinced Thurston to come to Ithaca, New York and establish the new program himself, which he did in 1885.

In 1880, Sweet sent a letter to a number of engineers in the northeast region to attend a meeting at Stevens Institute to form the ASME. At that meeting Thurston was elected the first president. Sweet was president in 1884. Thurston advocated a curriculum based on science, mathematics, engineering laboratories and mechanical shop skills. Under Thurston's leadership, Cornell was producing 20% of the mechanical engineers in the US in 1900. In the Archiv of the Deutsches Museum in Munich, the papers of Franz Reuleaux contain a printed lecture by Thurston on the new engineering science education. It is likely that both Thurston and Reuleaux had influenced each other in transforming mechanical engineering education. After Reuleaux's retirement in the late 1890s, a number of his critics rolled back the more theoretical elements of the mechanical engineering curriculum at Berlin. In the US however, the Thurston–Cornell model of engineering science education was replicated in other universities.

II.16 BERLIN AND THE MACHINE AGE OF THE 19TH CENTURY

Berlin in the 15th century was a garrison town for King Friedrich (Iron Tooth) of Brandenburg with approximately 7000 people and soldiers. This can be compared to Renaissance Florence that was a major European and manufacturing center of 50,000. In the late 17th century, during the reign of Friedrich Wilhelm, 'The Great Elector', 6000 Calvinist French Huguenots were permitted to live in Berlin after they were ousted from France. This brought over three dozen new trade skills into Berlin. Dutch and Jewish immigrants were also invited into the city and became part of the fabric of the commercial and manufacturing life of the city (Read and Fisher, 1994).

By the beginning of the 19th century Berlin was still very much a garrison city of around 170,000 and out of the main stream of the great industrial revolution raging in Great Britain. On the other hand, Belgium, where Franz Reuleaux's father and grandfather had manufactured steam engine pumps for the mining industry, was second only to Great Britain in industrial prowess at that time. Reuleaux's ideas about engineering and machines were influenced by his experiences outside of Berlin. Growing up near Aachen and studying engineering at the Polytechnic School at Karlsruhe, near the Rhine, Reuleaux was influenced by French ideas about technical education and their theories of machines. Aachen had been under control of the French at the beginning of the 19th century, and the university at Karlsruhe had adopted a mathematical basis for the study of engineering inspired by the curriculum of the Ecole Polytechnique in Paris. In some ways, Reuleaux had helped change Berlin more than it changed him.

From the early 19th into the early 20th century, Berlin had a dual personality. The government was strongly conservative and militarily oriented but Berlin had a population that was more cosmopolitan and liberal than most other German states. After the defeat of Napoleon in 1814, Berlin embarked on a path of development that would propel it and Germany ahead of England into undisputed industrial dominance in Europe. Before Reuleaux was 21, Germany was already a leader in several technologies such as electrical industry, pharmaceuticals and chemicals. For example, Siemens had established his electric technology factory in Berlin in 1847 when Reuleaux was only 19. In 1857, Wilhelm I assumed the Prussian throne and in 1862 installed Bismarck as Chancellor. By 1873, the Prussians defeated the French and Bismarck absorbed all the German states except Austria into a united German 'Second Reich'.

One of the unanswered questions about Reuleaux's thinking as a young man was his stand during the failed democratic revolution of 1848 that spread

across Europe. Some of his later writings seem to indicate that he was a rather broad thinker and not a reactionary. For a professional leader in a militaristic state, his espousal of technical development did not seem to be guided by military priorities and goals. This is in contrast to Leonardo and the Renaissance engineers whose patrons were always interested in the latest machines for military advantage. Reuleaux always thought that his theories of machines would advance science. He was also genuinely interested in industrial development for the betterment of mankind, perhaps influenced by his mentor at Karlsruhe, Ferdinand Redtenbacher. For example, Reuleaux understood the importance of small business and crafts workshops and had always hoped that new machines would be developed that would help provide small portable prime movers for such enterprises. Yet in his later years, as exhibited in his letters, he seemed to be proud of Germany's advances without any criticism of its dominant military posture. Reuleaux was not blinded by nationalism as evidenced by his harsh criticism of the quality of Germany's manufacturing *vis-à-vis* Great Britain and the United States at the Centennial Exhibition of 1876 in Philadelphia in his famous *Letters from Philadelphia* (1877).

Today we acknowledge the importance of the technical and scientific research university in the advancement of technology. In 1865, the United States Congress enacted the Land Grant Act that encouraged the States to establish universities that would teach mechanic arts and agriculture. Cornell University in New York State as one of these Land Grant universities, established a mechanical engineering program that by 1885 had an overall student body of approximately 300 and a faculty consisting of a few dozen professors. In contrast, Franz Reuleaux was the head of a Royal Industrial Academy (Gewerbe Akademie) in Berlin that was merged with the architecture based Bau Akademie in 1879 to become the Royal Technical University (Technischen Hochschule Berlin Charlottenburg) (Figure II.31). This became one of the world's largest technical universities with more than 3000 students and 300 professors. (Zopke, 1896) Franz Reuleaux was elected Rector of this university in 1890–1891. Berlin had an institution to train engineers in the science and art of machine making that fed the growing demand from German industry.

Reuleaux had access to powerful industrial leaders such as Werner von Siemens, Otto, and Mannesman. He was a government advisor and served on several national committees as well as on the Patent Office. He was someone who worked within the system even though Germany in the 19th century was not very democratic. Both Kaiser Wilhelm I and Bismarck regularly dismissed Parliament when they did not get their way.



Figure II.31. The Technische Hochschule Charlottenburg, Berlin c. 1900

Another factor in the engineering milieu of Berlin and Germany at this time was the existence of numerous industrial cartels that restricted competition. By 1900 there were over 300 such cartels. This sharing of industrial strategies by industries also involved a strong relationship with technical universities and engineering and science professors, a relationship that is still strong today. Reuleaux seemed to fit into such a system. His letters show that he regularly communicated with many industrial companies within and outside of Germany.

One of the important channels of technical communication in the 19th century was the international exhibitions. The first major event was in London in 1851. Reuleaux played a major role in many of these ‘world’s fairs’ for over 40 years often as Germany’s ambassador. He participated in Paris (1867), Vienna (1873), Philadelphia (1876), Sidney (1879), Melbourne (1881), Chicago (1893). Unlike the theme park atmosphere of 20th century World’s Fairs, these 19th century extravaganzas provided an opportunity for countries to show off new machines and technology that attracted the average public and not just technical experts. There is no doubt that Reuleaux used these occasions to learn about technology in other countries, which is reflected in the comments and footnotes in his books.

In some ways the two faces of Berlin, both militaristic and liberal reflected the different sides of Franz Reuleaux’s personality. He was studying engineer-

ing and philosophy while ignoring the revolutionary movements of 1848. He advanced the profession of mechanical engineering at the same time ignored the oncoming revolutions in electrical technology and aeronautics. He was a cosmopolitan traveler and global player in the industrial age at the same time uncritical about the nationalistic and militaristic posture of the new and powerful Germany. While Germany and Berlin were moving headlong into the 20th century and the debacles of World War I & II, Reuleaux was still a man of the 19th century, having served to move his profession and country across the threshold of the new century but unable to cross it himself.

Today a few of the old buildings of the Berlin Technical University have been restored after their destruction at the end of WWII. In front of one of these 19th century buildings, is a large monument to Franz Reuleaux, with the writing "*Franz Reuleaux Dem Forscher und Lehrer – Ergründer des Zusammenhanges der Technik mit Wissenschaft und Leben* (Scholar and Teacher; One who Probed the Connections between Technology, Science and Life). It was dedicated shortly after he died in 1905. His famous collection of mechanisms and machines was also destroyed in the war. At the Author's last visit to Berlin, this monument was covered with growing bushes and trees, a fading memory of the powerful Berlin of the 19th century Age of Machines in which Reuleaux played a significant role.

SOCIETAL BACKLASH: ANTI-MACHINE VOICES

The embrace of modern technology such as cell phones, pagers and digital cameras by the younger generation in the early 21st century was not always the pattern in earlier centuries. The development of the spinning wheel to create textile thread in the Middle Ages threatened the jobs of the drapers' guild in the 13th century. Likewise the invention of the printing press by Gutenberg in 1455 led scribes in Paris to reject Gutenberg's financial backer Fust when he tried to sell copies of the new printed bible there. In the 19th century, there was resistance to the steam engine driven high-speed printing presses of the inventor Friedrich König [1778–1833] at the Cotta printing works in Stuttgart (Strandh, 1979, p. 122). Other resistance was met by the introduction of the Jacquard automatic loom in France and the cotton gin in the United States. Perhaps the most famous anti-machine proponents were the so-called *Luddites* of early 19th century England. (See e.g. Sale, 1995.) Was there concern about the impact of machines on society by the machine designers themselves? There is little evidence that Leonardo da Vinci ever held reservations about the use of machines. However, Franz Reuleaux and other engineers of

the 19th century voiced concern over the negative effects of industrial technology.

The productivity gains and the industrial system that the machine brought into the 18th and 19th century was generally received with enthusiasm, especially in the United States, by those who were relieved from grinding physical work and who also marveled at the power that machines created. The American poet, Walt Whitman, in his epic collection of poems *Leaves of Grass*, written between 1855 and 1892, celebrated the railroad steam engine in the following lines:

Thy black cylindrical body, golden brass
and silvery steel,
Thy ponderous side-bars, parallel and connecting rods,
Gyrating, shuttling at thy sides,
Thy metrical, now welling pant and roar,
Now tapering in the distance.

In Europe there were many examples of anti-machine sentiment dating back to the Renaissance. The most celebrated case was the revolt of textile workers in England in the early 19th century, sometimes called the Luddites, that crystallized the anti-machine movement. In the early stage of the industrial revolution, manufacturing was organized around piece goods distributed through cottage workshops. Many people worked out of their homes. The emergence of the Watt steam engine in the late 18th century demanded a centralized workplace and workers were sometimes cut off from their families, homes and villages and worked for many hours per day and 6-7 days per week. On November 4 1811, in Nottingham, a small group of men destroyed several weaving machines of a master weaver motivated by complaints about wages, housing and the threat of loss of jobs. In the next two months this type of action spread and over two hundred textile frames were destroyed. Leaflets were distributed under the pseudonym of Ned Ludd calling for the destruction of the hated lace-making machines that could do the work of six men. Five hundred workers were already out of a job as a result of the new machines. In the spring of 1812, the rioting spread to the so-called Luddite triangle of Nottingham, Manchester and Leeds. According to Kirkpatrick Sale (1995), examples of machine breaking in the textile industry in England can be found as far back as 1675 and a century later in 1779 in Nottingham, where several hundred stocking frames were destroyed.

While workers displaced by automated machines raised their fists and lances, intellectuals and artists wrote anti-machine manifestos in the Romantic Movement in Europe and North America. Among the anti-machine

voices were the American writer Ralph Waldo Emerson and his English friend Thomas Carlyle. When Carlyle invited Emerson to tour England, his famous American friend wrote of his impressions of industrial England and the English with mixed images. His essay 'English Traits' describes his 1847 visit to England and Scotland, oddly to deliver lectures to several *Mechanics Institutes*, in northern England.

In a critical note Emerson wrote:

In the manufacturing towns, the fine soot or blacks darken the day, white sheep the color of black sheep, discolor the human saliva, contaminate the air, poison many plants and corrode the monuments and buildings.

In many parts of his essay on his travels to England he expressed some admiration of the English and their new system:

The bias of the nation is a passion for utility. They love the lever, the screw and pulley, the Flanders draught horse, the waterfall, wind-mill, tide mills: the sea and the wind to bear their ships.

Everything in England is at a quick pace. They have reinforced their own productivity by the creation of that marvelous machinery which differences this age from any other age.

In another section Emerson seemed resigned to the fact that it is natural for humans to invent machines – but cautioned about the loss of man's independence.

Man is a shrewd inventor and is ever taking the hint of a new machine from his own structure, adopting some secret of his own anatomy in iron, wood and leather to some required function in the work of the world. But it is found that the machine unmans the user. What he gains in making cloth, he loses in general power.

(Quotes from *The Complete Essays and Other Writings of Ralph Waldo Emerson*, Brooks Atkinson, Ed. The Modern Library, NY, 1940, 1950, 'English Traits', pp. 521–690.)

Another celebrated anti-machine book was *Erewhon*, published in 1872 by the English writer, Samuel Butler [1835–1902]. Impressed by his reading of Darwin's *The Origins of the Species*, Butler wrote an essay, 'Darwin among the machines' out of which came *Erewhon*. In *Erewhon* (the letters in 'nowhere' misordered), Butler's hero discovers a lost civilization that at one time had advanced technology and had now turned its back on technical

progress. In one chapter called ‘The Book of the Machines’ he describes why this group of people feared the machine:

There is no security – against the ultimate development of mechanical consciousness, in the fact of machines possessing little consciousness now. – Reflect on the extraordinary advance which machines have made during the last few hundred years, and note how slowly the animal and vegetable kingdom are advancing. – Is it not safer to nip the mischief in the bud and to forbid them [machines] further progress?

Butler’s novel was one of a genre called utopian literature of the 19th century. Another example is George Sand’s *The Black City*, published in 1860 in French. (Sand was a pseudonym for Amantine A.L. Dupin, [1804–1876].) This novel is part romance and part social criticism of the life of industrial villages. In Sand’s novel there are the workers; “*men and children, black with soot, coming and going among the warehouses and footbridges*” in the valley of factories, and there are the hill people who live in clean houses and own the factories. Yet these workers are noble:

There is nothing in the world more beautiful than the sight of these men working, so alive, so strong, each so dedicated to his own task.

In Sand’s ideal industrial city, new technology comes from below:

Sept-Epees [the hero] found some consolation in observing the rapid diffusion of innovative inventions and the ease with which they were absorbed and perfected by intelligent practitioners.

Clearly this novel had a mixed message that was not untypical of the age.

Echoes of this ambivalent attitude toward the machine and its relation to the human side of life in the Industrial Age can be heard in the writings of Reuleaux and his American counterpart Robert Thurston. Thurston who was an expert on the steam engine described his spiritual beliefs using the machine as a metaphor:

Man is a soul imprisoned and residing in a mechanism, a spirit, the image of God, brought to earth — His visible representation is as a marvelous machine, but it is a machine simply. He himself is of the invisible.

Franz Reuleaux spoke of the need to develop what today many would call ‘appropriate technology’ or small power sources that would enable the small craft shops to improve productivity without losing their traditional craft skills

and jobs to large industrial factories. In Reuleaux's famous treatise on the theory of the machine *Kinematics of Machinery* (1876), he wrote an entire section called 'The Relation of Machinery to Social Life'. His concerns may be summarized by the following quote:

–in the textile industry,– the results of change cannot be said to be in every respect advantageous. The home worker, the small master, has all but disappeared. This in itself may be in many instances a cause for regret. But with him has also disappeared much of his individual skill.

The breaking up of home life too which is involved in the factory system is a matter having many drawbacks.

Toward this end, Reuleaux helped Otto and Langen develop the internal combustion engine that he saw could be used as a small and affordable power source by small workshops.

It is in connection in these industries [small workshops] that the construction of small cheap prime movers becomes a matter of special importance.

I believe that in many places and circumstances it would be an advantage if the home-industry could be placed in a position to compete with the factory work. This can only be brought about when it is possible for the workman who has a little money at his disposal to buy a small and cheap prime mover–. It is in this direction that I look for a future for the gas engine which has lately been brought into practical shape–.

However it was the development of the small electric motor that helped the small workshop. Reuleaux did not seem to anticipate this technology, even though he was a friend of Siemens whose company was developing electric motors.

As much as Reuleaux decried the loss of skilled workshop trades in some industries, he saw that in others such as mining the replacement of the miner or colliers by the machine was a good thing.

In mining operations, for instance, we can look forward with un-mixed pleasure to the substitution of machine labor for much of the work of colliers and to the subsequent amelioration of the sad social conditions so often associated with such work.

Reuleaux and Leonardo seemed to have similar views on the role of technology and science in the world, namely the immutability of the laws of nature

that governed both the natural and technical world. In a folio in the *Codex Madrid*, containing a description of clock technology, Leonardo wrote

See what a wonderful thing it is to consider how nature performs all her functions and by what laws she has established the effects of all the causes and how these laws are impossible to change even in the slightest way.

Franz Reuleaux published a lecture in 1885, 'Cultur und Technik' on the necessary conditions for a society to advance into the industrial age remarked:

We cannot indeed do otherwise than attribute the change [into an industrial society] to a remarkable progress in the intellectual process; a difficult, hazardous ascent to higher and freer interpretations of nature. – that nature's forces in each of their manifold effects obey not the mandates of an ever intervening – a divine – Will, but act by the governance of immutable laws, and never do otherwise.

Reuleaux was likely influenced in his philosophical views of science and nature by his professor at the Polytechnique at Karlsruhe, Ferdinand Redtenbacher [1809–1863] who in 1857 wrote about the role of the use of technology in improving the life of humans:

In antiquity, physics, chemistry, mechanics, (as a science) did not exist, there was no appreciation of the fact that many forces existing in nature could be exploited to perform tasks useful to man; hence the general use of slave labour which even in the modern era has not entirely disappeared, though at any rate no longer considered normal, but as something which still survives, to a limited extent, while everything possible is done to eliminate it.

Spinning, weaving, turning, filing, etc. are activities which, the more uniformly they are taken, the better the result they give: hence in these cases the work done by machines is to be preferred to manual work, since, however skilled the worker may be, he cannot achieve as high a degree of uniformity as can easily be obtained with a well constructed machine? This ability to direct, dominate and control the forces of nature, thus making them work for us, has, especially in our epoch, assumed great importance. This capacity has in a short time been carried to a great degree of perfection and history will not fail to recognize the first half of the nineteenth century's contribution in this field. (Cited in Eco and Zorzoli, 1963, p. 279)

The relation between the machine and politics has some of its origins in the 19th century as when Karl Marx attended the lectures in London of Professor Robert Willis of Cambridge on the kinematics of machines. Marx was interested in Willis' definition of a machine. Later social historians of industrial capitalism such as Lewis Mumford (1934), in his tome *Technics and Civilization*, would express both wonder and criticism about modern technology.

The specific triumph of the technical imagination rested on the ability to dissociate lifting power from the arm and create a crane: to dissociate work from the action of men and animal and create the watermill;—

Mumford quotes Reuleaux on the first page of his book in defining the machine, and calls Reuleaux's book on kinematics "*The most important systematic morphology of machines: a book so good that it has discouraged rivals*". But Mumford's fascination with the machine does not temper his passionate belief in its evil with phrases such as "*purposeless Materialism*" or "*the dark blind world of the machine*". His clarion call for social control of the machine and its extension the industrial system as it existed in the early 20th century would be required reading for social critics of technology for seven decades later when the computer had supplanted the physical machine as the modern agent of social evil.

In many ideas, Mumford was very close to those of Reuleaux, especially in describing the change in human values, ethics and aesthetics that the creative inventions of mankind have made on civilization. Reuleaux in his *Kinematics of Machinery*, spoke of industrial automation as '*machinofacture*' and he commented on the unintended ideas of inventors:

especially to the fact that they have given up the attempt to copy the operations of the hand or that of nature in the machine, and have tried to make the latter solve each problem in its own way, a way often very different from that of nature.

Here are two men with similar views on the philosophy of the machine, but reaching different conclusions of its societal value.

Perhaps it is the nature of the engineer to be an optimist. Engineers have always been taught to solve problems and the possibilities of the machine allow many options for the engineer to address society's physical problems of shelter, security, energy, transportation, food, water and health. The social historian has only the power of words and persuasion; and sometimes in the face of social unrest and insecurity, as was the Depression of the 1930s when Mumford wrote his book, pessimism is the natural outlook. During the

Great Depression, Charles Chaplin, whose 1936 film *Modern Times*, comically showed workers being dragged through the gears of a giant machine, echoed Munford's pessimism when he was quoted in an 1933 interview:

Machines when used properly could be a bounty to mankind. If used to just make money, it could be a disaster.

II.17 LOST KNOWLEDGE FROM THE AGE OF MACHINES: MATHEMATICAL KINEMATICS AND ROTARY ENGINES

Kinematics of machines as a formal subject is not widely taught today, especially in North America. Courses in system dynamics, control and mechatronics have replaced those in design of mechanisms. There is an international federation of researchers who are making new advances in mechanisms and machine theory, the International Federation for the Theory of Mechanisms and Machines (IFToMM). But the vast majority of mechanical engineers trained in the last quarter century, do not have a deep knowledge of either kinematics or the wide variety of mechanisms and machines. Contemporary engineers now have an understanding of microprocessors and robotics but the profession is missing a certain body of knowledge in kinematics of machinery familiar to earlier generations. Looking at machine design of the Renaissance, modern engineers have no reason to design a catapult or a trebuchet, a lantern pinion, or a clock escapement. Technology and the applications of the modern world do not call for this knowledge. Likewise in looking at the 19th century, mechanical engineers no longer study the valve mechanisms of the steam engine or the tens carry mechanism of an arithmometer. However kinematic mechanisms still play an essential role in modern technology from engines to exercise machines, from robots to hard drives (Table I.1). Yet increasingly the roots of this knowledge, hard won in the 19th century, are slowly becoming ‘lost knowledge’ Some of this forgotten knowledge is embodied in many of Reuleaux’s kinematic models. Three examples are described below.

CURVES OF CONSTANT BREADTH

About a decade ago, many high school mathematics teachers discovered Reuleaux’s work on ‘*curves of constant breadth*’ and what many call ‘*the Reuleaux triangle*’. Several of these references can be found on the web by searching for Reuleaux. In *Kinematics of Machinery* (1876), Reuleaux defined two classes of constraints, lower and higher pairs. A lower pair involves surfaces in contact, as in the case of a cylindrical bearing. Higher pairs have line or point contacts between parts as in gear teeth. Reuleaux, in asking how many constraints are necessary to prevent a planar figure from moving, demonstrated that three point constraints may not be sufficient to prevent rotation of the object. He used as an example a curved equilateral triangle in a square hole (Figure II.32). The curved triangle is an example of a *curve of*

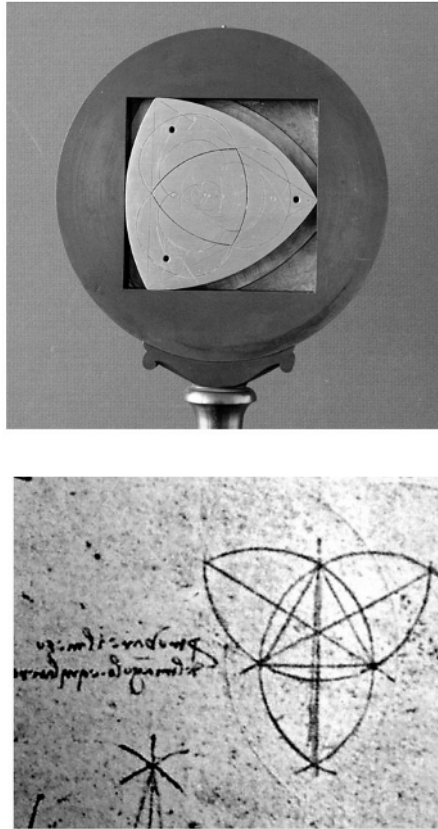

Figure II.32. Top: Reuleaux Triangle model (Cornell Collection of Kinematic Mechanisms); Bottom: Lunate drawing of Leonardo da Vinci, with a curved triangle figure in the center (Paris Manuscript A, Folio 15v)

constant breadth, and some mathematics texts refer to it as the *Reuleaux Triangle*, although its use in cam actuated steam engine regulators can be found as early as 1830. Cams are used for mechanical timing devices and to actuate control valves in machines, a function often replaced today with electronically controlled valves. An example of a curved triangle cam from the early 19th century may be found on a Woolf steam engine in the Science Museum in London.

Reuleaux also established that the complex sliding motion of a curved triangle in a square bearing is equivalent to the pure rolling of a smaller curved triangle on a curved square as illustrated in Figure I.26 taken from Reuleaux's *Kinematics of Machinery* (1876). These rolling curves, called *centrodes*, became important tools for the synthesis of new mechanisms. The use of cen-

trodes is still used today in the design of prosthetic joints in biomechanics of human joints (see Figure II.43).

He extended this idea to a whole class of curved polygons or ‘Reuleaux rollers’ that can roll between two planes without change in the gap width, hence the term ‘*curves of constant breadth or width*’. Far from being mathematical curiosities, curves of constant width are used in British coins (20p, 50p coins), and as a drill to make a square hole. They were also used as positive return cams in steam engine control valves at the beginning of the 19th century. Such cams had the property of a finite dwell period without the need of any added control system.

Although Reuleaux may have been the first to give a general discussion of the curved triangle, some mathematicians believe that the Swiss Leonard Euler first presented the idea in the 18th century. The curved triangle can also be found in the geometric and architectural drawings of Leonardo da Vinci, though there is no evidence that he knew of the constant width property, nor did he use the shape in a machine or mechanism. He drew the figure as a possible shape for a fortification. It was common in the Renaissance for architects to explore the shapes created by arcs of circles or lunate figures. Leonardo drew hundreds of these figures though most are related to a square symmetry. A lunate figure, based on the equilateral triangle, contains a curved triangle similar to the so-called Reuleaux triangle and can be found in a several drawings in the *Paris Manuscripts A and B* of Leonardo’s Notebooks (Figure II.32).

Following Reuleaux, Burmester (1888), gave a discussion of curves of constant breadth in his kinematics book. The mathematician Minkowsky (1911) also worked on the problem. In the 20th century, several mathematical books and publications refer to the problem of ‘Reuleaux triangles’ and rollers as in Rademacher and Topletz (1957), Yaglom and Boltyanskii (1961), Gardner (1969), and Goldberg (1948) even though the subject virtually disappeared from engineering kinematics textbooks. The use of curves of constant width in mechanisms may be seen in nine of the Reuleaux models in the Cornell Kinematic Collection (see the B and L series of models in the Voigt catalog). A tutorial on the Reuleaux triangle can be found on the kinematics website KMODDL (<http://kmoddl.library.cornell.edu>).

CALCULATORS AND STRAIGHT-LINE MECHANISMS

Another subject of ‘lost’ kinematic knowledge are so-called straight-line mechanisms and their more general counterparts of ‘mathematical’ kinematic

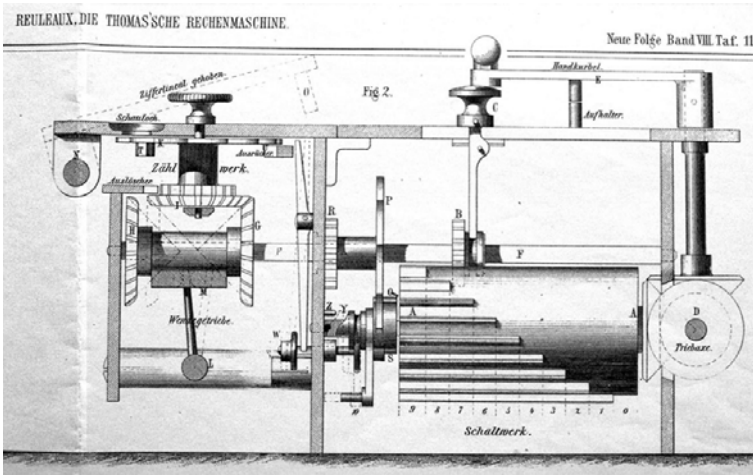

Figure II.33. Drawing of Thomas Arithmometer by Franz Reuleaux (1862)

linkages. It is not generally appreciated that computers and calculating machines had their origins in kinematics. An important link between kinematics and mathematics at the time was the question of the representation of *mathematical relationships using kinematic mechanisms*. Could mechanisms embody mathematical operations? Kinematic linkages can be designed to add, multiply and reproduce trigonometric and polynomial functions as well as perform integration of areas. Inputs of kinematic calculators can be designed using the turn of several gears and the output registered by the geometric movement of some link or gear. The famous Norden bombsight of World War II was one such device.

In the 19th century, an entire industry was established on this premise, inspired by the calculating machines of Leibniz and Pascal in the 17th C., and later by Babbage (1826, 1851) in the 19th century. Early in his career, Reuleaux (1862) wrote a paper about one of the first calculating machines called the *Thomas Arithmometer* in which he explained the stepped gear mechanism used in addition operations (Figure II.33) (see Moon and Lipson, 2007). By the late 19th century, mechanical machines could perform both digital and analog mathematical operations including adding, subtraction, and multiplication as well as integration, which spawned a calculator and business machine industry that created a demand for kinematic synthesis. The highpoint of analog kinematic calculators was the ‘differential analyzer’ of Vanemar Bush of MIT in the 1930s and similar General Electric machines used during and after World War II.

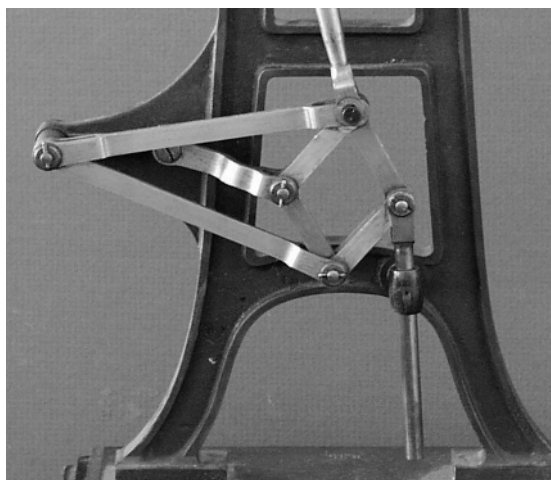

Figure II.34. Reuleaux–Voigt Model S-35 of a Peaucellier straight-line mechanism (Cornell Collection of Kinematic Mechanisms)

James Watt was famous for inventing a four-link mechanism that approximately drew a straight line for use in his steam engine, patented in 1784. The great Russian mathematician Pafnutii L'vovich Chebyshev [1821–1894] of St Petersburg University spent many years investigating the problem of the number of links necessary to draw exact mathematical curves. There is some evidence that he had proved that a five link mechanism could not draw an exact straight line. He invented several approximate straight-line devices himself (see e.g. Ferguson, 1962). It was a French engineer Charles-Nicolas Peaucellier [c. 1864] who showed that an eight-link mechanism (one link grounded) could produce an exact straight-line motion on some point on one of the links (Figure II.34). Later a Russian, Lipkin a student of Chebyshev, independently invented the same straight-line mechanism and was awarded a Russian prize for the effort only to discover that Peaucellier had published the idea a few years earlier. The Peaucellier–Lipkin mechanism was later used as part of a blowing engine for ventilating the English House of Commons in 1877 as well as for more pedestrian applications in lumber cutting machines. A tutorial on the Peaucellier mechanism can be found on the kinematics website KMODDL (<http://kmoddl.library.cornell.edu>).

As evidence that technology evolves as much by artisan tradition as by formal inventions, there have been several straight-line and parallel mechanisms in the craft of folding paper. One device, attributed to a Frenchman named Surrat, before Peaucellier's eight-link planar linkage, is a spatial, six-

link mechanism which is similar to folded screens used in musical devices and decorative arts.

Reuleaux thought these mathematical mechanisms were so important, that he designed 39 straight-line mechanisms in his model collection including those of Watt, Roberts, Evans, Chebyshev, Peaucellier, Cartwright and several of his own design. Some of these models can be seen at Cornell University, the Deutsches Museum in Munich, The University of Hannover, the Technical University of Dresden and at the Kyoto University Museum. In recent years, the Peaucellier straight-line linkage has been used in computer science to prove theorems about workspace topology in robotics. This mechanism is sometimes mentioned in advanced texts in the design of mechanisms, but for most students of mechanical engineering, it is lost knowledge.

Reuleaux also designed a double slider mechanism model to draw an exact ellipse. He attributed its invention to Leonardo da Vinci. Perhaps Reuleaux learned of Leonardo's work from the book of Grothe (1874) who was one of the first to study Leonardo's machines. One of these models is in the Deutsches Museum (DM06-6214) and is called an Ellipsenzirkel.

ROTARY PISTON MACHINES

The most ubiquitous mechanism in the world is the *slider-crank*, of which perhaps a billion exist in the world's automobile engines. These internal combustion machines are based on the kinematics of translating pistons. In the 19th century, there were many attempts to create *rotary piston engines*. (The first design for a rotary pump can be found in the machine book of Ramelli, 1588.) The rotary turbine of Parsons made it into the 20th century, and Wankel's rotary gasoline engine appeared in the 1940s, but barely survived past the 1980s. In *Kinematics of Machinery*, Reuleaux discussed the kinematics of what he called '*chamber crank trains*' and '*chamber wheel trains*', and included drawings of dozens of rotary engines, pumps and blowing or ventilator devices (Figure II.35). For each he cited the inventor and information on how each performed. He used his symbol notation to discuss their general classes of motions as well as the similar and dissimilar motions of these various inventions. His discussion of the rotating curved triangle in a square cavity (Figure II.32) may even have inspired some rotary engine inventions.

The German inventor Felix Wankel [1902–1988] of rotary engine fame wrote a review of the history of rotating piston machines in 1963 that was translated into English in 1965. His engine is now used in the Mazda sports car RX-7. He described dozens of different rotary engine concepts and used



Figure II.35. Reuleaux rotary engine models (Cornell Collection of Kinematic Mechanisms)

his own symbol classification and tabular scheme to organize this knowledge (Figure II.36). Wankel paid great tribute to Reuleaux referring to him as

the great dynamicist Franz Reuleaux who attempted nearly 90 years ago to bring order into the chaos of the rotary piston machine field

...

Wankel believed however that Reuleaux's symbol classification methodology was "*a little too artificial*" for the engine designer. Continuing his praise:

Reuleaux had apparently read all he could about the unsuccessful rotary heat engines which had been proposed in the preceding 150 years, ... his book included so many examples that it remained for decades the best known scientific review and collection of this type of machine.

Reuleaux was skeptical as to the practical application of rotary piston devices for energy machines because of seal problems between the moving parts and history has validated his criticism. It is remarkable that in Reuleaux's theoretical book of 1876, he included so much industrial level knowledge and advice. He cited literature and anecdotal references on machines and their

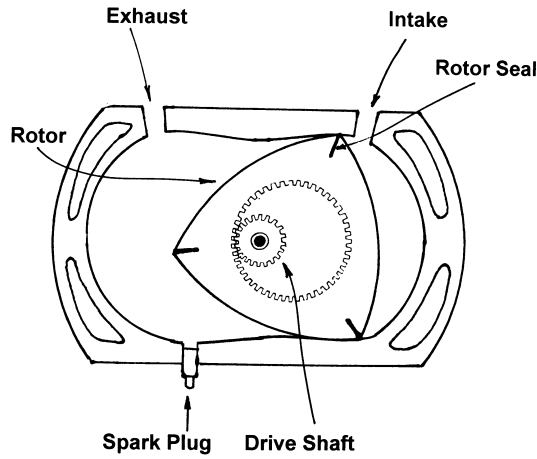

Figure II.36a. Wankel engine

7 Classification of single-rotation machines (SIM)

		INTERNAL-AXIS				
		no stationary chamber walls	outer or inner stationary chamber walls			
			outer	inner	outer	inner
I.	Reciprocating engagement					
II.	Arctuate engagement					
III.	Cam engagement					
IV.	Slip engagement					

Figure II.36b. Wankel's classification chart for rotary engines

performance from many countries showing his wide knowledge and communication with other engineers in machine engineering. In a world concerned with energy and the environment, Reuleaux's books and models, serve as a source of lost knowledge if there is ever a need to re-examine the rotary piston combustion engine using modern materials and control electronics.

In summary, although the process of machine design has advanced over the last five centuries from the time of Leonardo into a computer-based

methodology, there is much knowledge that has been largely forgotten in machine theory and design. A lot of this knowledge is not in the form of equations and formulas but takes the form of geometric and topological systems of machine components that have not been codified and digitally stored. Recently several universities have begun to digitally post mechanisms from their kinematic model collections. (See e.g. the 230 Reuleaux models at Cornell University on the web, <http://kmoddl.library.cornell.edu>.) Recently Leonardo's *Codex Madrid I*, with its 1000 machine drawings, has been placed in a web digital library. But the seminal work of the Russian Artobolovsky with 5000 mechanisms has not been digitized and posted on the web. Nor do we have methods to search these web libraries for suitable mechanisms and designs. A web-based project (due to appear in 2007) to search for kinematic mechanisms suitable for a given application is underway at the Technical University in Aachen, oddly not far from Reuleaux's birthplace. Without new computer search tools however, modern engineers may have to rediscover lost machine knowledge once common to engineers in the past.

II.18 PRIME MOVER MACHINES: THERMODYNAMICS, KINEMATICS AND MATERIALS

Prime movers are a class of machines that transform a source of energy into motion and power. The most familiar prime movers are automobile engines, electric motors, steam turbine electric generators and wind turbines. Today we have numerous sources of energy including, nuclear, chemical, water, wind and solar machines. Electrical energy is generally derived from these five. Under chemical processes are included gas, oil, coal and wood. Almost all prime movers, except electric motors use a *working fluid*, such as air, steam, water or hot gases. In many machines energy sources create heat that is transferred to a working fluid. The conversion of thermal energy in the working fluid into mechanical and electrical power is the subject of *thermodynamics*.

The creation of modern prime movers, such as gas turbines for aircraft or electrical power generation, involves the engineering sciences of thermodynamics, dynamics, kinematics, tribology and materials engineering. Although the focus of this book is on the kinematics of machines, no history of machines can ignore the important area of thermodynamics for which we give a very brief review here. Many of the laws of thermodynamics were posited without reference to specific machines and thus research in this field was largely confined to academic physics. Kinematics of machines had a direct connection to the geometry of real machines and was largely carried out by engineers. Materials engineering had roots in both industrial materials processing, as in the development of new methods of producing iron or steel, as well as by physicists, chemists and mathematicians in academia.

It is a strange fact that the great age of steam engines was largely advanced without the theory of thermodynamics. The evolution of the steam engine was passed forward through the work of Christian Huygens [1629–1695], Denys Papin [1647–1712], Thomas Savery [1650–1715], Thomas Newcomen [1663–1729] and James Watt [1736–1819], mainly centered in Great Britain. There was also much research in physics during this period on the concepts of heat and temperature.

Evidence for the lack of thermodynamic knowledge by steam engine designers, may be found in the classic work by the British engineer John Farey (1827), *A Treatise on the Steam Engine*. (Farey calls prime movers, *first moving machines*, and devices that are moved by prime movers, *secondary machines*.) This tome (778 pages), complete with detailed plates of steam engines, begins with a litany of prior art and inventions going back to Hero of Alexander. He also cites the machine books of Salomon de Caus (1615),

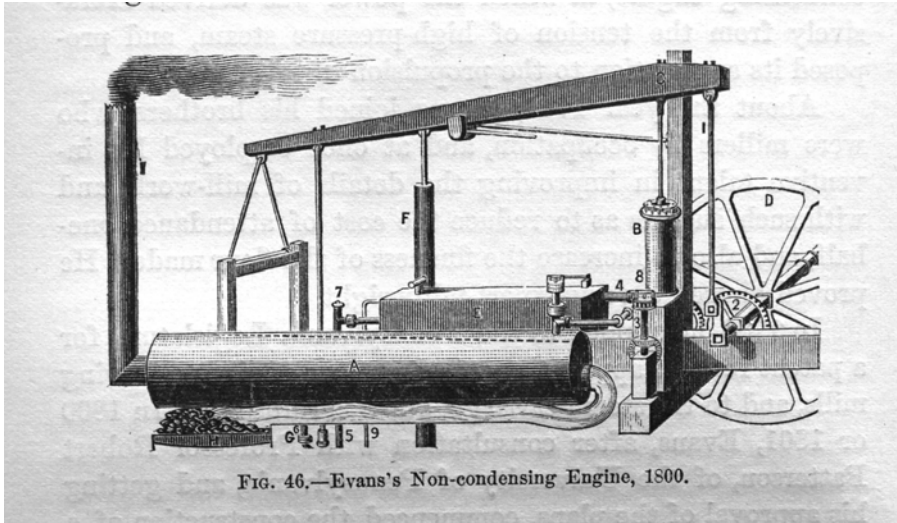

FIG. 46.—Evans's Non-condensing Engine, 1800.

Figure II.37. Oliver's Evans steam engine of 1803 (Thurston, 1878)

Giovanni Branca (1629) and Otto von Guericke (1672) whose experiment with horses pulling on two half-spheres under vacuum is often reprinted in popular histories of technology. After this extensive historical review, he presents a summary of the principles of mechanics, such as levers, force equilibrium and the dynamics of falling weights. Aside from an experimental discussion about the ‘elasticity of steam’ there is no mention of any thermodynamic relations governing heat and mechanical energy. The American engineer Oliver Evans (1805) published a similar treatment on the properties of steam in a short handbook on the steam engine (Figure II.37).

There is some evidence that Leonardo da Vinci made experiments on the expansion of water into steam. There are small sketches in the *Codex Atlanticus* and *The Codex Leicester* (Folio 15r) (now owned by Bill Gates), of a vessel with water and a piston above designed to measure the volume displaced by the evaporation of steam (Figure II.38). Some have claimed that Leonardo invented a steam turbine on the basis of a sketch in the *Codex Atlanticus*, Folio 21r (folio 5v.a, old) that shows a hot gas flue with a four-blade turbine driving a roasting spit below through a gear transmission. This device can also be found in the drawings of Taccola and Francesco di Giorgio, and appears in later ‘theatre of machine’ books of the 16th and 17th centuries.

The first great thermodynamics principle relating to the process of generating mechanical power from heat was presented by Nicolas L.S. Carnot [1796–1832]. (Carnot’s father was an important figure in the French Revolu-

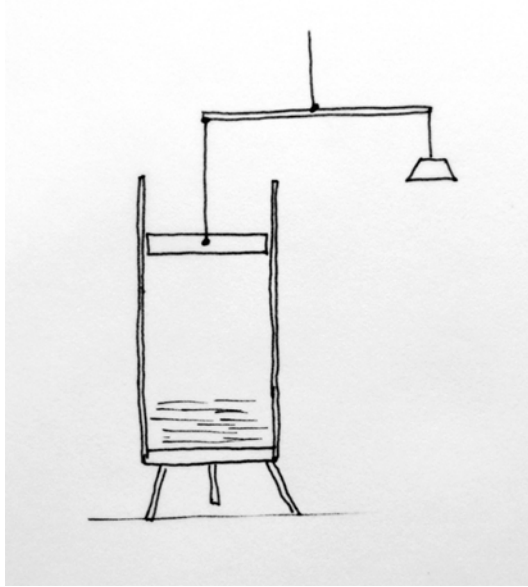

Figure II.38. Leonardo da Vinci sketch for an experiment to measure the expansion of steam

tion as well as a scientist with an interest in machines.) Nicolas Carnot was a French engineer who studied at the Ecole Polytechnique in Paris. He wrote his famous paper on the maximum efficiency of prime movers operating between two temperatures in 1824. His work was largely ignored for ten years until it was referenced in a paper by B.P.E. Clapeyron [1799–1864] two years after Carnot’s premature death due to cholera (see Gillispie, 1970). This theorem became the foundation of the *second law* of thermodynamics. Further work on Carnot’s theorem followed in 1850 by the German, Rudolf J.E. Clausius [1822–1888], as well as by William Thomson (Lord Kelvin) in 1850, 1851. Clausius was the first to introduce the term *entropy* into thermodynamics.

The so-called first law of thermodynamics relates ideas of energy, work and heat whose maturation developed more than a century after Newton. Thurston (1902) wrote that the American Benjamin Thompson presented a paper in 1798 proposing that heat and mechanical energy could be made equivalent. Thompson (also Count Rumford) deduced from experiments a work-heat equivalent close to the accepted value of 778 foot-pounds of work necessary to heat a pound of water one degree Fahrenheit, called a *British Thermal Unit* or BTU. In the early 19th century, many scientists performed experiments to ascertain the heat equivalent of mechanical work. In 1843 James P. Joule of England performed the most extended experiments that es-

established the amount of heat that a unit of mechanical work could produce. This was almost 60 years after Watt's first steam engine.

The Scotsman William J.M. Rankine [1820–1872] also extended Carnot's work in 1849. Of the engineering scientists working on machines, Rankine was perhaps the broadest, having contributed to thermodynamics, kinematics and materials of machine design. The American scientist, Josiah W. Gibbs [1839–1903] of Yale University, was known for his theoretical contributions to chemical thermodynamics. Oddly his doctorate was in engineering and his short dissertation was on the geometric shape of gear teeth. Franz Reuleaux, in fact, wrote to Gibbs for a copy of a paper related to dynamics.

The other important area of machine design is *materials engineering*. Materials processing was an important industry in the 18th century. Iron making, coke production, glass, ceramics, porcelain, and basic chemicals such as sulfuric acid created demands for new machines. For example, the steam engine was developed out of a need to pump water out of deep coal mines as well as for blowers in iron and coke production. Materials engineering has a number of sub branches such as materials properties measurement, the creation of new materials and enhanced materials properties through processing and post process heat treatment. The subject of metals production was once called *metallurgy* but is now a sub field of *materials science* as new materials such as microelectronics, optical materials and plastics became important.

The characterization of mechanical properties of materials is now called *mechanics of materials*. One of the first studies of elastic properties of metals was by Robert Hooke who in his research on clocks, read a paper before the Royal Society on 1676 on the theory of springs. His name on 'Hookes law' relating the applied force to the displacement is still taught to engineers today. However besides the elastic properties of metals, the inelastic or plastic and failure loads for materials are also of importance in machine design.

For many centuries wood, copper, brass and iron, both cast and wrought, were used to construct machines. As pressures were raised in steam engines, the strength of boilers and cylinders became important and the stress capacity of machine materials became paramount. As operating speeds were increased in machines, dynamic properties came to the fore such as dynamic friction and wear between moving parts as well as dynamic fatigue. Rankine (1868) was one of the first to study fatigue failures in machines. Fatigue is the destructive process of the growth of small cracks in a machine element under cyclic stress that can lead to catastrophic failure of the part and the machine. Today the subject of friction and wear between materials is called *tribology*. Robert H. Thurston's tome on the materials of engineering was one of the first

to assemble properties of materials of machine building based on experiments in his materials laboratory at Stevens Institute of Technology.

In the mid 19th century, steam pressures began to rise and there were a growing number of tragic accidents of steam boilers blowing up in both stationary boilers and vehicle steam engines. One occurred in the United States Civil War in a steamboat carrying several thousand prisoners of war and over a thousand men were lost. At the time of the forming of the American Society of Mechanical Engineers in 1880, there were on the order of several thousand deaths per year in the United States due to boiler explosions. The US Congress asked the ASME to come up with a design code for safe construction. Of particular importance were the analysis of stresses and the material properties of the boilers. When the ASME released its famous ASME Boiler Codes, insurance companies required operators to follow this design code and within a decade the number of fatalities dropped dramatically. This example illustrates another step in the social diffusion of engineering knowledge away from the secrets of the workshop and into the use of mathematical and experimental engineering science to create safe machines. Today the ASME boiler codes are standard guidelines for the design of pressure vessels, including nuclear reactor systems.

Robert Thurston of Stevens Tech and Cornell University and the first president of ASME, was one of the world's experts on the steam engine and materials engineering. Thus the choice of ASME to address the dangers of steam technology made use of some of the best minds on the steam power at that time. Also ASME provided a bridge between the academic engineers and those who actually built the machines in industry. (As a side note, Reuleaux was one of the first honorary foreign members of the ASME.)

The elastic behavior of materials was also important, codified under the title *theory of elasticity*. Reuleaux was one of the first to propose a rational design methodology for the design of elastic springs. He also proposed that the design of machine parts be based on the elastic stress limit. The mathematical theory of stress in solids was carried on from the 18th through the early 20th century. Today this subject has largely been replaced by numerical stress calculation using software called *finite element codes* and mathematical stress analysis has become another area of 'lost engineering knowledge'.

Before the age of steam, prime movers were human, animal, wind and water. The development of machines related to these energy devices, were largely independent of the laws of thermodynamics. The principles related to machine design were those of mechanics and geometry. One of the human operated pumps was a lever, like a playground seesaw (Figure II.12b), with a

man on one side and the pump cylinder or water bucket on the other, not too different from the ancient Egyptian ‘shadoof’ used to irrigate fields. When a truly thermodynamic machine emerged with Thomas Newcomen’s dual cylinder steam engine water pump, it was virtually geometrically identical to a dual cylinder pump that had its origins back to the writings of Vitruvius (1st century CE) and the Greek engineer, Ctesibius of Alexandria (c. 1–3 BCE). Up until the 18th century, until the age of steam, single and dual cylinder pumps, based on the lever, were actuated by human, animal or waterpower. There are several drawings of dual cylinder mechanisms in the Notebooks of Leonardo da Vinci. He did not invent this topology, as some have claimed, as it seems to have been a part of the lingua franca of kinematic mechanisms before and after the Renaissance.

When the concept of steam power matured, inventors naturally used the so-called *balancier* lever with the steam cylinder on one side and the pump cylinder on the other as in the early Newcomen and Watt machines. Interestingly, the first electromagnetic motors were of a rocking type with the same balancier topology as the early steam engine. To complete the evolution of this concept, the Morse-Vail telegraph receiver used for the first message between Baltimore and Washington in 1844, also used a rocking lever topology, with the steam cylinder replaced by the electromagnetic force and the pump replaced by the dot-dash marker.

James Watt made experiments on the nature of steam and he discovered with Professor Black of Glasgow University properties of the latent heat of steam. Thus his revolutionary improvement in efficiency using a separate steam condenser was likely based on thermodynamic intuition nurtured through such experimentation and less on any thermodynamic theory (see Section II.14). His three kinematic improvements, the straight-line mechanism, the planetary gear drive and the rotating ball speed regulator were mathematical in nature. The steam engine of the early 19th century was an example of technology leading the science of thermodynamics. Improvements in iron and steel, created a demand for pumping and blowing machines that led to improvements in the steam engine in the late 18th century. Such is the complex relationship between technology, science, mathematics and materials that continues to this day.

Clearly there was no thermodynamics theory in the time of Leonardo da Vinci. Thus it was not unusual for engineers to propose perpetual motion machines. Leonardo drew a version of such a machine that was popular at the time, but gave arguments as to why it would not work. Later authors of the so-called ‘theatre of machines’ books did draw such perpetual motion

machines into the 18th century such as those of Böckler (1661) and Zonca (1607) and Leupold (1724). (See Ord-Hume, 1977, for a popular book on perpetual motion machines.)

It is interesting to note that the principles of thermodynamics were not discussed in Reuleaux's two major books on machine design, nor in the fourth edition of his popular design book *The Constructor* in 1893. Reuleaux's colleague at the Swiss Federal Polytechnique in Zurich (ETH) was Gustav Zeuner, whose expertise was in thermal systems and machines. Also Reuleaux had been in contact with Robert Thurston of Cornell University who was an expert in the application of thermodynamic principles to the steam engine. It appears that thermodynamics was one of the blind spots in Reuleaux's theory of machines.

II.19 FLYING MACHINES OF LEONARDO AND LILIENTHAL

If James Watt's steam engine marked the beginning of the Age of Machines in the late 18th century, then the aero-machines of Samuel Langley, the Wright brothers and Glenn Curtiss marked its end and the beginning of the modern age in the early 20th century. When Leonardo da Vinci's manuscripts were translated and published in the late 19th century, they captured the imagination of many historians, especially his designs for flying machines. His drawings of manned aircraft have appeared in hundreds of modern books and Leonardo has been hailed as the prescient inventor of flying machines though his designs were never built and his works never published in time to have influenced Wilbur and Orville. With the 100th anniversary of the Wrights' flight now past, it is tempting to ask what if? What if his friend Melzi had published Leonardo's designs after his death? Would they have changed the evolution of flying machines? Would humans have taken to the air sooner? To answer these questions we have to find out what exactly Leonardo knew about flight and what was the prehistory of flying machines before the Wrights.

Leonardo da Vinci drew over 500 sketches related to flying machines, the flight of birds and the flow of air. Some of these writings have been gathered into a book entitled *Sul Volo degli Uccelli* (1505) or 'The Flight of Birds'. According to the historian Charles Gibbs-Smith (1967), Leonardo's designs for human-carrying flying machines were made in the period 1486-1496 before his study of birds. Most of these sketches appear in *Manuscripts A-M* now in the Institute de France and in the *Codex Atlanticus* in Milan. These drawings are mainly of *ornithopters*, or flapping mechanisms designed to emulate the movement of birds' wings by a human pilot (Figure II.39). Many of these devices contain complicated linkage not unlike the kinematic devices drawn for machines for textile machines or clock escapements. One of his flying devices even had a gear wheel pair.

Gibbs-Smith (1967) has classified Leonardo's machines into Prone, Standing, and Powered Ornithopters. These designs rely on an assembly of cables, cranks, pulleys, and linkages. The wing-like structures were designed to undergo a four-stage motion of flapping from the shoulder joint, twisting, minor flapping of the outer wing and return stroke. According to Gibbs-Smith these designs were more like exercises in exhausting the possibilities of combinations of machine elements than serious flight machines that could actually be flown. The Standing Ornithopter designs added cable-wound drums and a retractable landing and ladder mechanism that would have greatly added weight to the otherwise overweight flying machine. The so-called Powered Ornithopter used stored elastic energy in a crossbow device to create the com-

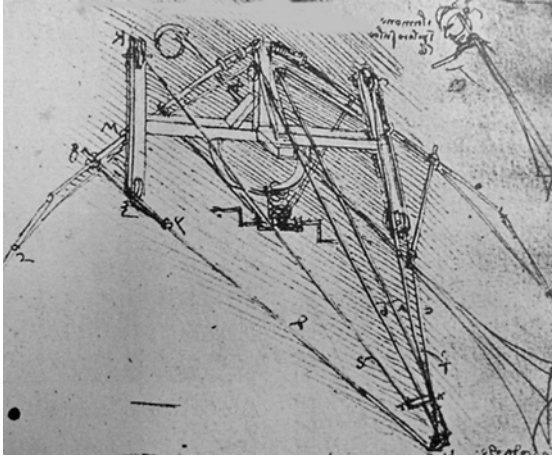

Figure II.39. Ornithopter design of Leonardo da Vinci, *Paris Manuscripts*

plicated flapping motion. Presumably the pilot would have to periodically re-draw the crossbow mechanism to maintain the flapping motion. The crossbow would be called a ‘compliant mechanism’ in contemporary machine design parlance.

There was very little understanding of the laws of flight in Leonardo’s designs such as how lift is created or how one controls the stability of a flying machine. There are designs for wings, but one cannot say Leonardo had a systematic design for a glider, say, though modern enthusiasts have reconstructed such a wing and completed the design for such as craft. There is a parachute for controlled decent and one design of a vertical airscrew or Archimedes screw for controlled ascent into the air that led many to claim that Leonardo had invented the helicopter. Gibbs-Smith points out that even had these machines been built, these flapping mechanisms would not have generated sufficient lift to support the weight of gravity of a human even using modern materials. Leonardo did not understand the laws of scaling that permits creatures of a certain size to attain lift by flapping such as birds and insects and restricts humans to flight by gliding. What is clear from the sketches of these machines is the playfulness of using different combinations of kinematic machine elements in seeking a solution to the problem of flight; a kind of Renaissance ‘brain storming’. There are sketches of bird-like wings in his Notebooks, (e.g. *Codex Atlanticus*, Folio 846v (folio 309v.a, old); Folio 858r (folio 313v.a, old) and recently some have taken to building glider models with such designs and in some cases have achieved limited flight, claiming that perhaps Leonardo had tried to fly. Again there is no evidence that he

ever built such a glider. As to credit for Leonardo's fantasies of human flight, one must remember there were others centuries earlier such as Roger Bacon (Section II.5) who had similar dreams of flight.

In looking at the uniqueness of Leonardo's drawings in designing wings, we have to remember that most of the art in the Renaissance had a religious connotation and that winged angels can be found in hundreds of paintings and sculpture of the time. Some of these winged angels have very bird-like wings as in a terracotta piece *The Resurrection* by Verrocchio (c. 1470), now in the Bargello in Florence. We must remember that Leonardo was trained in Verrocchio's studio and very likely learned to draw such winged appendages. The bronze doors of the Baptistery by Lorenzo Ghiberti next to the Cathedral in Florence, completed before Leonardo was born, contain many images of winged angels. In Leonardo's own paintings we can find a large winged angel in the *Annunciation* now in the Uffizi, Florence, as well as one in the *Virgin of the Rocks* in the National Gallery, London. Surrounded by such winged imagery, it is not difficult to imagine a young boy in church, bored with the Latin prayers he could scarcely understand, looking at pictures of humans with wings and trying to design in his mind machines to create his own angels.

In one famous drawing, Leonardo drew a test wing that was attached to a four-bar linkage, in which the flapping is actuated by a human as shown in *Manuscript B* (Folio 88v) (see Figure II.25). The drawing seems to place this rather symmetric wing on a hill, perhaps meant to capture the wind. A smaller sketch of the wing has it attached to a weight of 200 libbre (about 68 kg) and the modern interpretation is that Leonardo wanted to see if the wing could generate sufficient lift to pull the weight off the ground (see Taddei et al., 2006). This interpretation of the experiment has a problem because one must analyze the forces in the linkage to determine the force of the wind on the wing and the force on the weighted lever. It is not likely that Leonardo knew how to determine the forces in a four-bar linkage. Another strange feature of this wing is that its symmetry does not seem bird-like. A similar wing design can be found in a painting attributed to Francesco di Giorgio, now in the Uffizi in Florence, portraying the trials of San Benedetto being tormented by a flying devil with a symmetric wing coming out of each shoulder with a shape similar to that in Leonardo's drawing (see Toledano, 1987, pp. 86–89).

Serious experiments on flight can be traced to the early 19th century by George Cayley in England, as well as the 18th century balloon flights in France of Montgolfier and others. In the decades before the famed Wright flights, there was the pioneering work of Otto Lilienthal [1849–1896] in Germany who was a student of Franz Reuleaux at the Gewerbe Institute

in Berlin from 1867–1870. Lilienthal by the way had started a company to make steam engines and other machines ‘Otto Lilienthal, Berlin; Maschinen, Dampfkessel Fabrik’. His experiments in flight were not his only occupation. Americans often like to think that the brothers Wright captured the idea of human flight. Attempts to understand the possibilities of flight were under study in Europe for nearly a century before the tests at Kitty Hawk in 1903. The Prussian government for example, in 1867, set up a committee to study flight called the ‘Commission to draw up a Program for Experiments with the Objective of Ascertaining the Laws of Air Resistance with regard to the Production of Steerable Aircraft now being used’. Franz Reuleaux of the Royal Industrial Academy was the second chair of this commission and had suggested Otto Lilienthal, one of his former students as an assistant. Lilienthal declined the seat and shortly thereafter began his famous experiments in manned gliders. Later, the Commission was headed by the famous physicist, Hermann von Helmholtz.

In the US, Samuel P. Langley had obtained government funds to build a prototype flying machine in the decade before Kitty Hawk. Langley tested a steam powered aircraft model on the Potomic River near Washington in 1896 that flew over a kilometer. His tests of a full-scale machine in 1903, proved disastrous and it fell to the Wrights to complete the achievement with private backing. Though many tried to romanticize the Wrights as intuitive, bicycle mechanic geniuses, the Wrights conducted serious engineering wind tunnel experiments and had access to world research efforts through the work of Octave Chanute. Chanute had published a very influential monograph in 1894 called *Progress in Flying Machines*. Chanute summarized the work of Lilienthal in this book. Lilienthal had written his own book on bird flight in 1889, *Der Vogelflug als Grundlage der Fliegekunst*. Chanute was an important node in a network of engineers, scientists and flying adventurers. Chanute gave a lecture on the progress on flying machines at Cornell University in the late 1890s, which was published in the Journal of the Sibley College of Mechanical Engineering. He gathered information about flying and disseminated information to many aviation pioneers including the Wrights and Glenn Curtiss. (Curtiss was part of an American team organized by Alexander Graham Bell that actually flew the first public manned flight in 1908 at Hammondsport, New York. The Wright’s 1903 tests were done in secret to protect patent rights.)

With regard to machine design the Wrights introduced a compliant mechanism through their use of bending or warping the wings to achieve flight stability. In contrast the Curtiss–Bell plane used a kinematic aileron flap mech-

anism. Here as in other so-called inventions there were precursors such as similar warping devices in the gliders of Lilienthal a decade earlier. Some modern interpreters of Leonardo's drawings of wings and flying machines have suggested that he understood the need for a warping control to achieve stability, but this is speculation.

The above brief survey of the history of human flying machines is again an illustration of the five conditions for inventing a useful machine discussed in the section on Watt's steam engine, Section II.14. By the turn of the century, (i) there was a tradition of building gliders and flying machines, (ii) there existed a cadre of engineers and designers developing skills in making flying machines and light weight motors, (iii) there were financial backers, be it the government in the case of Langley, or an income business in the case of Lilienthal and the Wrights or a deep pockets capitalist such as Bell in his support of Curtiss; (iv) that there was a spirit of progress in the industrial countries is an understatement and (v) there were certainly men with vision and motivation to design machines to lift humans into the air. Also the revolution in flying machines evolved naturally from the age of the steam engine and the internal combustion engines that eventually replaced them.

Before the Wrights built their aircraft, they had asked the Smithsonian Institution for information, books, and reports etc. on flight. Wilbur Wright wrote about this material:

When we came to examine these books, we were astonished to learn what an immense amount of time and money had been expended in futile attempts to solve the problem of human flight . . . Men of the very highest standing in the professions of science and invention had attempted the problem: Leonardo da Vinci; Sir George Cayley, . . . Professor Langley, Sir Hiram Maxim, Mr. Thomas A. Edison . . . and a host of others.

The Wrights and other aircraft inventors had knowledge of Leonardo's work as well as contemporary inventors. By the end of the 19th century, Leonardo's ideas were no longer unique in a crowded field of aircraft builders each of whom wanted to be first in human flight.

Regarding Leonardo and the advancement of flight in the 19th century, we must ask how early were his manuscripts available to aircraft researchers in the 19th century. Some of his manuscripts were studied with respect to his work in science and technical advances in the late 18th century in Paris. J.B. Venturi (1797) who had also studied hydrodynamics published a book on Leonardo's scientific work. Later in the 1870s, Hermann Grothe of Berlin wrote articles on the machines of Leonardo based on photographs or litho-

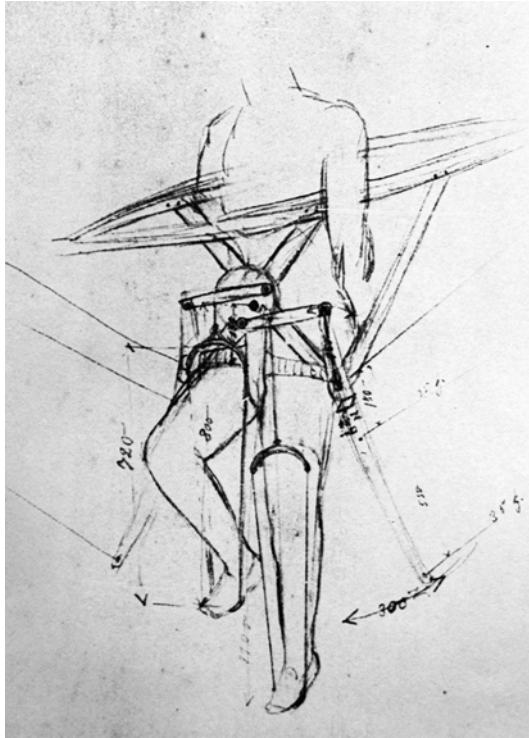

Figure II.40. Otto Lilienthal aircraft design sketch circa 1889 (Archives of the Deutsches Museum, Munich)

graphs of some of the Paris and Milan Notebooks of Leonardo. A set of these photos and lithographs may have been at the Royal Industrial School in Berlin where Reuleaux was its head. Reuleaux had in fact read Grothe's manuscript on Leonardo's machines before publication. Thus it is not without too much imagination to suppose that Lilienthal, who attended this Institute, may have had knowledge of Leonardo's drawings of ornithopter designs.

Based on archival material on Otto Lilienthal and his brother Gustav in the Deutsches Museum in Munich, one can suppose that they had access to Leonardo's wing and ornithopter designs by the late 1880s. However from their letters they acknowledged that Leonardo's ornithopter designs were a dead end path to flight. Drawings of Lilienthal of designs for manned gliders have some aspects of the kinematic linkage mechanisms used by Leonardo (compare Figure II.39 with Figure II.40). The drawings of Lilienthal exhibiting complex linkages and cables to be actuated by the pilot seem to resonate with Leonardo's ideas.

Of course Lilienthal made his greatest progress with gliders. Lilienthal performed hundreds of experiments to improve his gliders and also had a concept of wind-generated lift that Leonardo did not likely possess. Unfortunately Lilienthal was killed in one of these glider tests in 1896 seven years before the Wrights successful flights. Here one must agree with Gibbs-Smith in his assessment that Leonardo's designs would not have flown but it is possible that his drawings may have inspired Lilienthal who had seen some of the copies of Leonardo's drawings circulating in Europe at this time. Individual folios were published in Milan in 1872. Facsimiles of the *Paris Manuscripts A–M*, that contain many writings about the flight of birds was published in 1881–1891. *The Codex on the Flight of Birds* was published in Paris in 1893, and the facsimile of the *Codex Atlanticus* was first published in Milan 1894–1904.

The realization of manned flight in the early 20th century is an example of the avalanche theory of invention in which many sub-component technologies and sciences came together to launch humans into controlled flight. Aeronautical engines evolved from the attempt to make fast, lightweight motorcycle engines. Alexander Bell added Glenn Curtiss to his manned flight team because Curtiss had developed a fast motorcycle engine that propelled him to a world speed record in 1904 of over 220 kph (137 mph) (Shulman, 2002). Gas engine driven vehicles were developed by Karl Benz in 1885, a student of Redtenbacher. These engines had in turn evolved from the Otto-Langen gas engines of the 1860s to which Reuleaux had been a valuable consultant. In his writings, Reuleaux did not envision the age of flight toward which he had played a small part. Another Reuleaux student at Berlin, Hugo Junkers [1859–1935] went on to head an aircraft firm that built some of Germany's most famous airplanes in the early 20th century

The idea of human flight, likely a dream of millions of people before the 20th century, was advanced by many technical artisans, adventurers, scientists and engineers in many cultures, most heavily in the century before the Wright Brothers. Flying machines evolved like the steam engine before it, from many failed attempts by both dreamers and practical builders. More so than the steam engine, the role of scientific concepts of fluid mechanics began to play an increasing vital role in building these new machines. If one can again paraphrase the saying 'it takes a village to educate a child'; *it takes a civilization to create a new machine, especially one that can fly*. Perhaps it also took a few small boys from the 15th and 19th centuries, sitting in church, looking at winged angels and imagining what it would be like to build winged machines.

II.20 KINEMATICS OF ANIMAL AND HUMAN MOTION

MAN AS MACHINE AND MAN IN THE MACHINE

Kinesiology is the application of the laws of mechanics and anatomy to the study of human motion. With the emergence of rational methods to explore architecture and engineering in the Renaissance, it was natural that similar approaches to the study of the human body would emerge during this era.

Before the scientific age, which began in the Enlightenment of the 18th century, living beings were often viewed by the lay public in terms of spirits, myths, gods, mystery and symbols; an organic whole connected one to another. The idea that one could deconstruct the human body into separate parts each of which could be further dissected into cells and molecules was not only a missing intellectual construct, but one that would have been considered heresy in many religious traditions. Other missing concepts were that the functions of organs could be explained with scientific principles and that the collective motions of skeletal parts could be analyzed with principles of mechanics and mathematics. There were many exceptions to the non-scientific view of life going back to Greek medicine. Beginning in the Renaissance earlier Greek ideas about anatomy were re-examined and then radically changed, spurred on by new knowledge in science, mechanics and mathematics.

Machine engineers and biologists are not often seen as having common interests and talents. But in the machine eras of the Renaissance and Industrial Revolution one can find men whose interests spanned both fields. Leonardo of course was considered one of the great anatomists of his time as well as a consummate machine designer. Franz Reuleaux and other machine engineers of the 19th century also tried to use their scientific and mathematical tools to analyze the mechanical aspects of animal and human motion.

Leonardo's anatomical descriptions of human bodies were based on more than 30 autopsies. Many of his anatomical drawings were done later in life after he had developed ideas of basic machine elements and the use of the exploded view to uncover the workings of the machine. In his second period in Milan, 1505–1513, Leonardo began serious anatomical drawings using the same techniques for machine drawings. Leonardo's method was to uncover each layer of structure of the basic biological elements of the body; skeletal bones, muscle, tendons, nerves, arteries and veins and major organs. The historian Paolo Galluzzi of the University of Florence has written that Leonardo tried to show the analogy between the machine and the human body. In one of Leonardo's outlines for a book, Galluzzi notes, da Vinci wrote that a dis-

cussion of the elements of machines should preface the ‘motion and strength of man and animals’ (Galluzzi, 1997).

Greek anatomy can be traced to the works of Aristotle, Hippocrates and Galen. In the second century Galen [c. 130–c. 201 CE] born in Pergamum, (sometimes referred to as Claudius Galenus) worked in Rome and was physician to the emperor Marcus Aurelius. He dissected many animals and also summarized the discoveries of Greek medicine and anatomy such as that of Hippocrates in a work of 22 volumes. This work was copied by the Arabs in later centuries and republished in Arabic. One of these works is by Avicenna or Abu Ali al-Hussein ibn Abdalla ibn Sina. In the late Middle Ages, Galen’s theory of medicine was taught at Paris and Italian Universities. Mondino di Luzzi, a professor at Bologna wrote an anatomical work based on an Arab version of Galen called *Anathomia* (1316). With the development of the printing press of Gutenberg around 1450, a version of this 14th century anatomy was widely published, bound in another work *Fasciculus Medicinae* (1491–1494). The *Fasciculus* contained woodcuts on surgery. This work is mentioned in a list of Leonardo’s books found in the *Codex Madrid II*. According to Vasari, the great anatomist Marc Antonio dalla Torre had helped Leonardo in his anatomical drawings around 1510. The majority of anatomical drawings of Leonardo da Vinci are found in the Windsor manuscripts acquired by the British crown in the 17th century and rediscovered in a trunk in 1778. The famous English anatomist William Hunter viewed these drawings in 1784 and was amazed at their detail and Leonardo’s depth of understanding of the physiology of the organs he was drawing (see e.g. Nuland, 2000).

Other artists of the Renaissance performed or were present at autopsies including Michelangelo, Albrecht Dürer, and Raphael. Shortly after Leonardo’s death in 1519, Andreas Vesalius published the first post Galen anatomy in 1543 entitled *De humani corporis fabrica*. Vesalius studied at Paris and Padua. Although Leonardo’s anatomical studies were the most detailed of his time, he was in the vanguard of other scientific and artistic efforts to obtain a more detailed description of the human body than the doctrinaire Galen and Aristotle texts. A few years later, the French born Pierre Belon [1517–1574] who studied medicine in Paris and botany in Germany, published a book on birds in which he compared the skeletal figures of the human and bird and noted the homologies between the two species.

An architect-engineer who may have influenced Leonardo da Vinci about painting and the human body is Leon Battista Alberti [1404–1472]. In the *Codex Madrid II*, Leonardo listed two books of ‘Batista Alberti’; one on architecture and another on measurements (*Un libro da misura di Bta. Alberti*).

Alberti had a family background similar to Leonardo's. He was an illegitimate son of an exiled Florentine merchant. Alberti initially studied medicine at Bologna but switched to mathematics and natural sciences. He lived in Venice, Padua and Rome where he found a love for ancient forms and proportions of architecture and art. Unlike Leonardo, he published several works including one on painting and another on architecture, modeled after the first century Roman Vitruvius Pollio (*De re aedificatore*, 1452, printed in 1485). In these works Alberti combined the language of engineers with the art of rhetoric to posit his theory and rules for good painting and architecture (see e.g. Grafton, 2000).

Alberti believed that the artist should develop skills in geometry and anatomy. He should compile notebooks of nudes and body parts. Symmetry and mathematical proportion in both painting and architecture were to be sought. (Reuleaux, early in his career, posited similar criteria for machine design.) Alberti also wrote of the use of optics and visualization of a 'pyramid of rays' emanating from the subject of the painting. The artist must treat the body as a machine that obeys the laws of mechanics; e.g. the motion of an arm should be counterbalanced with the opposing motion of a leg. Alberti referred to earlier kinematic classification of 'seven motions' such as circular, wave-like, snake-like motions in portraying hair or the other moving objects. Leonardo's interest in anatomy from a mathematical as well as biological viewpoint as a tool for the artist was not unique for this period. Leonardo took this interest in anatomy to greater depths than any of his contemporaries and predecessors and went well beyond what was necessary for the artist. As the historian Bertrand Gille (1966) has pointed out, Leonardo was one of several artist and architect-engineers of the Renaissance, including both Francesco di Giorgio Martini and Leon Battista Alberti who began to use a language of engineering, mechanics, and mathematics to describe and understand many other sciences including anatomy.

These observations suggest that Leonardo's study of machines, and the drawing principles used to portray the functions of these machines, may have provided the intellectual tools to represent and codify his observations in his dissections and autopsies. Alberti's books on architecture were patterned after the work of Vitruvius. Vitruvius and other Greek and Roman thinkers recognized rules of drawing and design based on geometric proportions such as the 'Golden Mean'. The adoption of such mathematical rules in drawing the human form was also used by Leonardo. His classic drawing of a man with stretched arms inside a circle was done for a new edition of the first century work of Vitruvius published in 1511. Here the height of the man to the radius

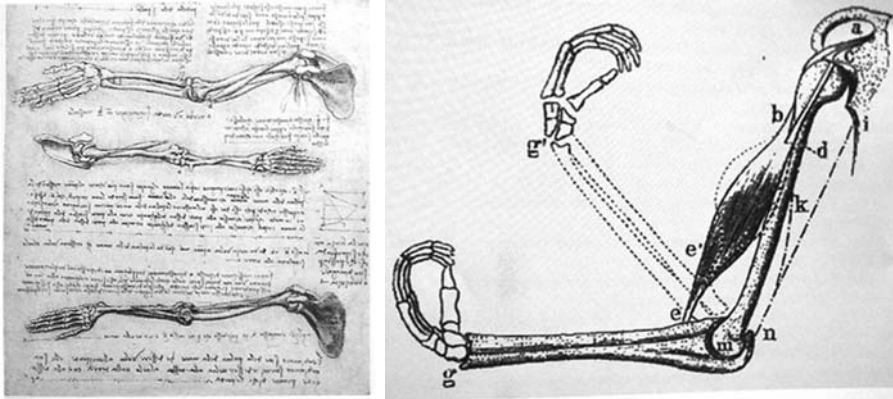

Figure II.41. Left: Drawing of an arm by Leonardo da Vinci; Right: Drawing of an arm by Reuleaux (1900)

of the circle, the man’s navel being the origin of the circle, is the golden mean $\phi = 1.618 \dots$ (Atalay, 2004). The proportions of some aspects of the design of the Greek Parthenon also contain elements of the Golden Ratio.

The relative proportions of a naked youth can also be found in a drawing of Francesco di Giorgio, in his *Trattato I Codex Ashburnham 361* (Folio 15v) in Florence Biblioteca Medicea Laurenziana, a copy that was believed in Leonardo’s library. A drawing of the proportions of a man in a circle and a square can be found in Mariano Taccola’s *De Ingeneis*, of the mid 15th century, a work that likely influenced Francesco di Giorgio (see Scaglia et al., 1992).

In the late 19th century, Reuleaux used his kinematic terminology for machines to describe skeletal relationships; the bones represent links and the joints or connections represent kinematic pairs, mostly of the revolute kind with one or two degrees of freedom. The muscles in Reuleaux’s scheme are represented by active prismatic or sliding joints and passive tension elements. We can see the seeds of these ideas in the work of da Vinci. In Figure II.41, the left drawing is from Leonardo da Vinci’s Windsor manuscripts, and the right one is from Franz Reuleaux’s *Kinematics of Machinery*, Second Volume (1900). In this Reuleaux’s last major work he tried to describe motions of animals and humans using his kinematic ideas developed for machines.

LEONARDO ON ANATOMY, MACHINES AND MECHANICS

In the following quotations of Leonardo, taken from the English translations of da Vinci’s Notebooks by MacCurdy (1938), we can see how Leonardo

linked his anatomical studies to ideas in mechanics and mathematics. Most of these quotations are taken from the Windsor manuscripts, in England.

Why nature cannot give the power of movement to animals without mechanical instruments, as is shown by me in this book on the works of movement which nature has created in animals. And for this reason I have drawn up the rules of the four powers of nature without which nothing through her can give local movement to these animals. (Quaderni I Ir)

We shall describe this mechanical structure of man by means of diagrams of which the three first will treat of the ramification of the bones; that is the one from the front which shows the positions and shapes of the bones longitudinally; the second as seen in profile –; the third diagram will show the bones from behind. Then we shall make three other diagrams from the same points of view with the bones sawn asunder so as to show thicknesses and hollowness – (Folio B 20v)

On the Anatomy of the Hand

The first demonstration will be made of the bones alone. The second of the ligaments and various nerves that bind them together. The third will be of the muscles which spring up upon these bones. The fourth will be of the first tendons which rest upon the muscles and go to supply movement to the tips of the fingers. The fifth will be that which shows the second set on tendons which move all the fingers and end at the last but one of the bones of the fingers. The sixth will be that which will show the nerves that will impart sensation to the fingers of the hand. The seventh will be that which will show the veins and arteries that nourish and invigorate the fingers. The eighth and last will be the hand covered with skin . . . (Fogli A 10v)

Of the Limbs in Action

After the demonstration of all the parts of the limbs of man and of other animals you will represent the proper method of action of these limbs, that is in rising after lying down, in moving, running and jumping in various attitudes, lifting and carrying heavy weights, throwing things at a distance and in swimming, and in every act you will show which limbs and which muscles are the causes of the said action, and especially in the play of the arms. (Fogli A II v)

The function of the nerves is to convey sensation; they are the team

of drivers of the soul, for they have their origin from its seat and command the muscles so that they move the members at the consent of the will of the soul. (Quaderni II 18 v)

Show a man on tiptoe so that you may compare a man better with other animals. (Quaderni v 22 r.)

On the Gait of a Man

The gait of a man is always after the manner of the universal gait of four-footed animals; seeing that as these move their feet crosswise, as a horse does when it trots, so a man moves his four limbs crosswise, that is he thrusts the right foot forward as he walks he thrusts the left arm forward with it, and so it always continues. (*Codex Atlanticus*, Folio 815r: folio 297r.b, old)

One of the principal sources for English translation and discussion of Leonardo's anatomical manuscripts is that by Charles O'Malley and J.B. De C.M. Saunders of the United States in 1952, republished by Dover in 1983. They describe Leonardo's interest in a cinematographic theory of body motion or a description of the limits of human motion based on the geometric constraints and mechanics of the musculoskeletal system. For example in discussing the rotary motion of the hand, (pronation and supination), Leonardo noted the constraints of the radius and ulna bones that connect the wrist to the elbow. The idea that geometric constraints define the kinematic possibilities of a mechanism reappear in the works of Robert Willis (1841), and Franz Reuleaux (1876a), in their definitions of a machine.

Leonardo in describing the anatomy of the human form recognized the basic elements of robotics; geometric constraints, workspace, muscle actuation, nerve sensors and a controller that in his case is not very clear. In some passages he refers to the spirit or soul that controls messages to the nerves and muscles. The basic elements are there for an anthropomorphic vision of automated machines or robotics. In Vasari's biographic sketch, he described an animated lion that Leonardo had built for the French King in Milan. The automaton took a few steps and then opened up to reveal flowers for the honored royalty. It is unfortunate that we do not have Leonardo's design drawings for this pre-robotic machine. The robot designer Rosheim (1994, 2006) has a very well illustrated book called *Robot Evolution*, in which he made a case for a lost robot design of Leonardo. (See the next section, Section II.21, for a discussion of automata and robotics.)

MAN IN THE MACHINE; BIOMECHANICS IN THE 19TH CENTURY

More than four centuries after Leonardo, machine theorists of the 19th century also used their new tools of descriptive geometry, calculus and thermodynamics to analyze animal and human motions and functions. These included Robert Willis of Cambridge, William Rankine of Scotland, Ferdinand Redtenbacher of Karlsruhe, Robert Thurston of Cornell University in the USA and Franz Reuleaux of Berlin. There were two areas of interest in 19th century bioengineering; modeling the human as a machine and how to treat the animal or human as part of a machine.

Both Willis and Reuleaux were interested in the application of mechanics to biology, though it is likely that Reuleaux was influenced in this area by the work of Redtenbacher and Willis. Willis' early work in biomechanics was on the mechanics of the larynx. Later he applied the kinematic theory of machines to the skeletal linkage of fish in his 1841, 1870 books. Similar work can be found in Reuleaux's second book on kinematics (1900) in which he applied his symbol notation to the linkage of fish and other animals. Today Reuleaux's kinematic methods are often cited in the biomechanics literature in the design of joint prosthesis research (see Menschick, 1987).

In 1818, J.A. Borgnis published a treatise on the *Composition of Machines* that extended the pioneering work of Gaspard Monge (1795) and Lanz and Betoncourt (1809). The Italian Borgnis further divided the components of machines into parts that receive force or energy, those that transmit the work and those that control, regulate and operate with the force and motion. In the first part of his book, Borgnis described 'Des Moteurs Animes' including 'Zooliques' and 'Mus par les homes' or animals and humans. Of the 43 plates, Borgnis devoted Plates 1–3 (50 figures) to machines with animal and human motion sources. Similar drawings of animal and human sources of energy in machines may be found in the 'Theatre of Machines' books of Besson and others such as de Caus and Zonca in the 16th and 17th centuries.

Reuleaux discussed Borgnis' theory in his 1875 treatise on *Kinematics of Machinery* in both the Introduction and in Chapter XII on the analysis of complete machines. Here Borgnis' *recepteur* element is called (in the English translation of Kennedy) the 'receiver of motion'. Reuleaux showed that the human element in a machine becomes an equivalent closed kinematic chain in which one or more links are moved by muscular forces. From this point of view, Reuleaux argues, the animal or human power is no different than an inanimate prime mover such as a steam engine. He did not raise the question of the nature of the muscle producing forces. Reuleaux used for example one of Borgnis' figures of a man climbing an endless chain of knots called

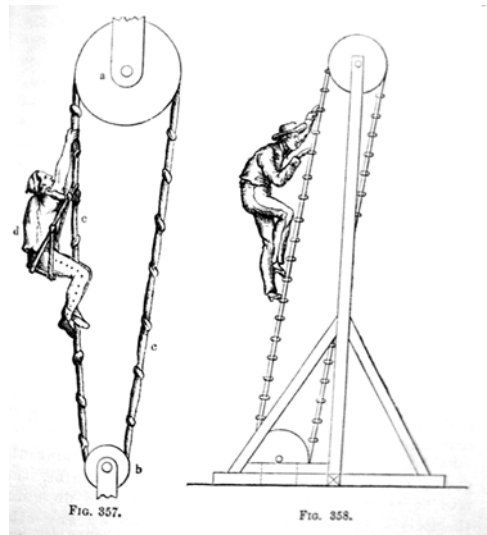

Figure II.42. Man in the machine; sketch from Borgnis (1818)

‘Berthelot’s knotted belt (Figure 357, Rx; Plate 3, Figure 7, Borgnis (1818)) as well as a man climbing an endless chain drive between two pulleys, called Borgnis’ flexible ladder (see Figure II.42). In Reuleaux’s theory of machines, there is neither mystery nor mystique of the human in the machine; he or she is simply reduced to a kinematic chain of elements that happens to exert forces or power.

It was noted earlier that Leonardo did not draw machines with animate sources of motion such as horses or humans. But animals and humans in machines appeared widely in the ‘theatre of machines’ books such as *Taccola* (c. 1450), *Ramelli*, (1588), and *Zonca* (1607). Reuleaux’s theory of the human/animal machine places a kinematic foundation for this earlier tradition.

Paradoxically, as the steam engine was replacing human and animal power in the 19th century, the question of the nature of animal and human effort received great attention from both scientists and engineers. Engineers tried to place a value on the magnitude of the forces and power that animate elements could exert, such as the measure of ‘horsepower’ – 550 foot-pounds of energy per second. Scientists tried to apply the new sciences of chemistry and thermodynamics to account for the food energy source and the effort of work output of horses and men.

For example, Ferdinand Redtenbacher, Reuleaux’s professor at Karlsruhe, in his book on mechanical engineering, wrote a short section on *Der Mensch und Thiere als Motoren*, or ‘Humans and Animals as Motors’ (p. 431, *Der*

Maschinenbau, Erster Band, 1862, Mannheim) Here he summarized the forces and power that horses and men can generate.

Robert Thurston published a small monograph on *The Animal as a Machine and a Prime Mover* (1894) in which he discussed the limits of force and power of humans and animals comparing their capabilities with machines using the new science of thermodynamics. Thurston wrote with surprise that the energy balance of animals and humans could not be reconciled with this new science. Although kinematics was a maturing field at this time, the thermodynamics of bio-chemical reactions in the body was yet to be established.

Reuleaux had had contact with Thurston, perhaps as early as 1873 when they were both at the World Exhibition in Vienna. In his earlier books, Reuleaux did not discuss the application of kinematics to biology. Thurston sent Reuleaux a copy of his 1894 book and Reuleaux promptly translated it into German. In the second volume of his book on kinematics, Reuleaux devoted an entire chapter to kinematics of the skeletal system and its analogy with kinematic chains in machines (Part III of Vol. 2 of *Lehrbuch der Kinematik* (1900), ‘Kinematik in der Thierreich’ or kinematics in the animal kingdom.) He analyzed the joints and linkages of several fishes and crustaceans. (See e.g. Kerle and Helm, 2000.) He also discussed a model for muscle actuation. In examining the anatomy of shellfish from the point of view of kinematic chains, Reuleaux described a symbol representation of the mechanisms of shellfish claws and jaws. Original drawings of his anatomical sketches may be seen in the Archiv of the Deutsches Museum. There were earlier discussions of the animal as a prime mover in Willis (1841), Laboulaye (1864), and Redtenbacher (1862–1865) though not in the detail as in Thurston or Reuleaux’s books.

Around the turn of the century, Reuleaux had been in contact with a doctor of medicine, O. Thilo from Riga. Thilo later reviewed Reuleaux’s chapter on animal kinematics for a journal (Thilo, 1901). After Reuleaux’s death in 1905, Thilo sent the Deutsches Museum several kinematic wooden models of fish illustrating some of Reuleaux’s ideas. These models were used in a display in the Museum, under the title, *Kinematik in Tierreich*, which was the title of the chapter in Reuleaux’s book of 1900. These models are now in storage in the Deutsches Museum. It is likely that Reuleaux was as much influenced by Thurston and Thilo and others as they were by his work

By the late 19th century, mechanics, electromagnetism, optics, etc, were mathematically codified to such an extent that engineers could reliably use these equations for design of machines. It was natural then that engineering scientists such as Redtenbacher, Reuleaux and Thurston would try to apply

this methodology to biology, not only from an intellectual point of view, but also from the view of the animal as part of the technical system. One of the early biomechanics models given to the Deutsches Museum in 1910 is an arm prosthesis with mechanical fingers actuated by the upper arm muscles using kinematic linkages. This model has the name of Professor Sauerbruch, presumably from Germany. It is not known if he had any connection with the work of Reuleaux who died in 1905.

Kinesiology

While machine theorists of the 19th century were using the new science of machine kinematics to describe human and animal motions, experimental kinesiology enjoyed great progress with the work of Marey in France and Muybridge in the United States using the new technology of photography. Etienne-Jules Marey [1830–1904] a contemporary of Reuleaux, studied medicine in Paris and later used a camera to analyze the dynamic motions of humans using the technique of ‘slow motion’. In 1873, he published a book entitled, *La Machine Animal: Locomotive terrestre et aerieenne*.

Eadweard J. Muybridge [1830–1904] another contemporary of Reuleaux and Marey, became the Chief Photographer for the United States Government. He invented a camera shutter with an exposure time of 1/500 of a second. Using a series of 24 cameras, each triggered at a fraction of a time apart, he was able to decompose the trotting motion of a horse and show that part of the time the animal’s feet were off the ground, thus establishing the dynamic nature of the horse’s motion as opposed to pure kinematic motion of the legs. Around 1884–1885 he conducted a series of photographic experiments at the University of Pennsylvania on the motion of humans and animals, published as *Animal Locomotion* (1887) and *The Human Figure in Motion* (1901). Muybridge also exhibited at the 1893 Chicago Fair at which Reuleaux attended as an official German delegate. We do not know if the two men met however.

Reuleaux’s ideas on the existence of rolling surfaces for the relative motion of two bodies are still used today in the study of prosthesis design in biomechanics. Using his ideas, one can design a 4-bar linkage to create the same relative motion between the femur and lower leg to replace a damaged knee joint, so long as the centrodes for the four-bar linkage match those of the natural femur-tibia relative motion (see e.g. Menschik, 1987) (Figure II.43).

Walking Machines

It is curious that while biological evolution did not produce a wheel mechanism in animal life, human engineering evolution has had great trouble pro-

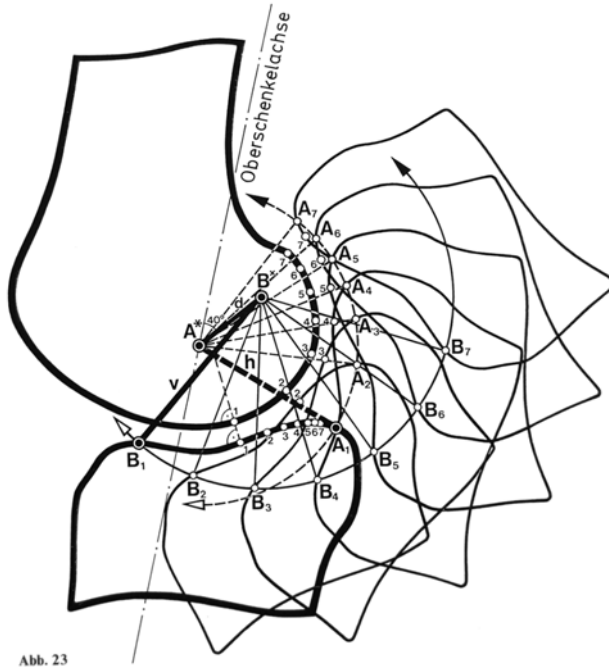

Figure II.43. Four-bar mechanism replacement for a knee joint (Menschik, 1987)

ducing walking machines. There is brief mention in Vasari of a walking lion created by Leonardo for a pageant. There is also evidence that the Chinese had invented a walking ‘horse’ mechanism that would carry heavy loads over rough terrain (see Yan, 2005; see also Figure II.44). During the late 19th century the great Russian mathematician Chebyshev invented a complex linkage that would exhibit a gaited motion and move in a straight line. Recently Professor Hong-San Yan of Tainan University in Taiwan has constructed a 21st century version of a walking horse using eight-link mechanisms that are now available as toys. In 1893 L.A. Rygg patented a mechanism that was powered by a human and moved like a mechanical horse, similar to the Chinese walking horse. Thus the saying ‘there is nothing much new under the sun’.

Rosheim (1994) in his book on robot evolution described the effort of engineers in the late 20th century to create two, four and six-legged robots. There have been some modest successes but none has made it to the application marketplace. In the 1990s Honda engineers built an elaborate feedback-controlled two-legged robot that could negotiate stairs and mimic other human walking motions. The price tag for such machines is more than a million dollars. The search for walking machines has gone through several phases.

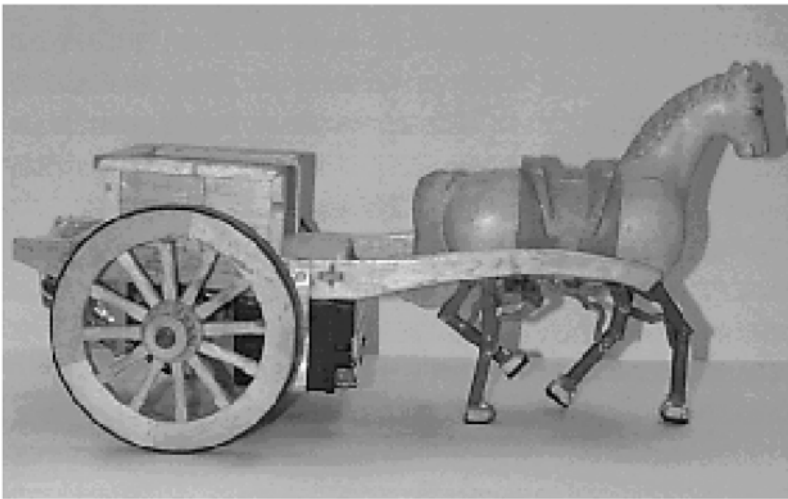
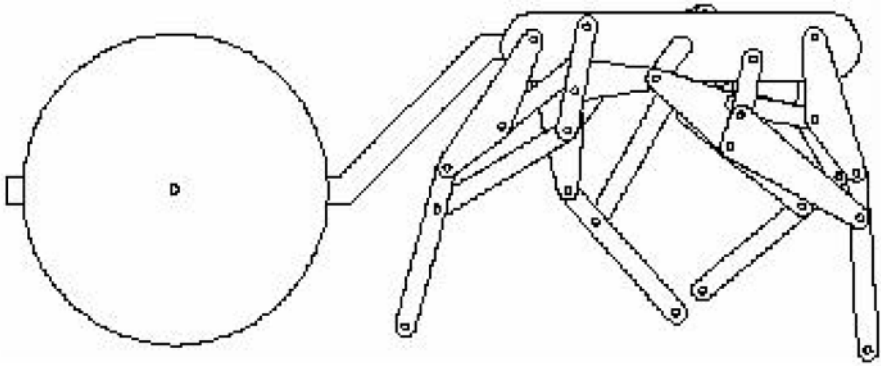

Figure II.44. Chinese ‘walking horse’ design of H.-S. Yan (2005), Tainan University, Taiwan

During the 19th century kinematicians such as Chebyshev looked for passive walking machines without control feedback. In the late 20th century with the development of smaller and more powerful computers and miniature electronics the efforts on walking machines focused on control theory. In 1986 Mark Raibert of Carnegie Mellon University (now at MIT) published a book describing his experimental work on dynamic hopping machines that uses dynamic balance with control to create running machines (see Raibert, 1986). Now there is change toward a new search for passive walkers.

Tod McGeer in 1990 and Andy Ruina (2005) of the United States have created a series of kinematic mechanisms that use natural dynamic forces to stabilize walking machines with zero or small feedback energy (Figure II.45).

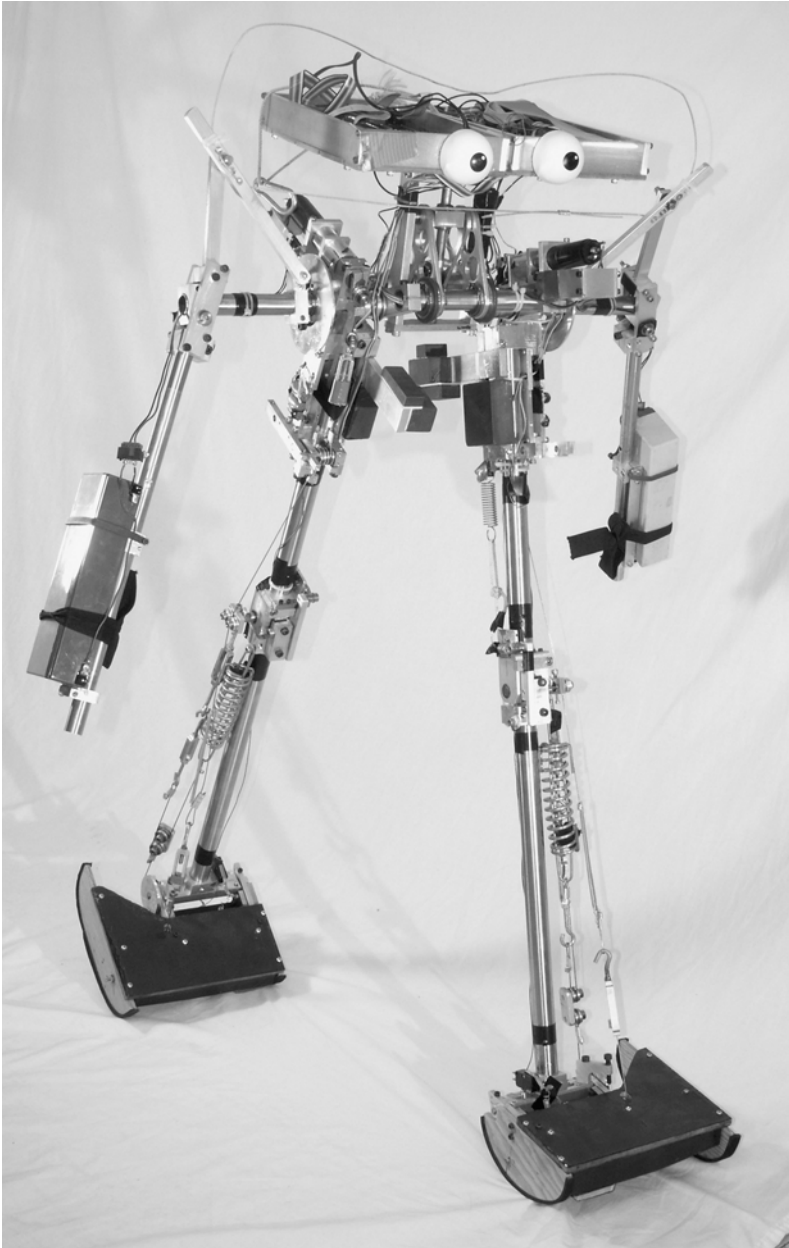

Figure II.45. Passive walking machine, Professor Andy Ruina, Cornell University (see Collins et al., 2005)

These successes have lent credence to the belief that Vasari was not exaggerating when he boasted of Leonardo's walking lion. A theory that Leonardo designed plans to build a robot-like machine is discussed in the next section. But a look at Ruina's Cornell website, and the videos of walking linkages without feedback control, makes one ask: why it took so many centuries to discover such machines when all the kinematic elements were known so long ago?

Living in the modern age of specialization one can become a little jealous when reading of earlier historical periods where creative people made important contributions to such disparate fields such as machines and biology or art and engineering. Although Leonardo and Reuleaux are often considered remarkable for their periods, historical evidence shows that they were not unique, nor singular in these interdisciplinary pursuits. Today there are many universities with bio-medical engineering programs that have formalized the study of human biology and engineering; yet another modern specialization. A historic look at this 'new' discipline of bioengineering will show roots starting in Greek science, mechanics and the study of machines, continuing through the Renaissance and Industrial Ages.

II.21 LEONARDO IN A ROBOT: AUTOMATA, CLOCKS AND CONTROLLED MACHINES

When one examines a basic robot manipulator arm used in manufacturing as in Figure I.9, the mechanical components can be deconstructed into elementary machine elements and kinematic mechanisms. What is remarkable is that most of these basic elements can be found in the machine drawings of the Renaissance engineers including the manuscripts of Leonardo da Vinci. Linkages, belt drives, gearing, even a gimbal mechanism, were known in the 15th century. Could robotic-like, automaton machines have been created in the 15th century? An *automaton* can be defined as a machine that can be pre-programmed to perform some function or display a sequence of motions. As for Leonardo inventing such a machine, we have but scant clues such as Vasari's following note:

During this time the king of France [Charles VIII] came to Milan and Leonardo was asked to prepare something for his reception. He constructed a lion which advanced a few steps, then opened its breast which was entirely filled full of lilies.

From the age of the ancient Greeks to the Arab ascendancy, machine inventors and engineers created mechanical *automata*. These early devices were meant to entertain and were often driven by water. With advances in clock technology, many clever 'automaton' devices were invented to represent animal and human motions. One of the intriguing theories posited in recent years has been that Leonardo da Vinci had designed an automaton and that these designs were used to construct a walking lion and a walking knight for court entertainment. One of the principal authors of this theory is Mark Rosheim of Minneapolis a well-known robot engineer and historian. Rosheim (1994) had published a very useful book on the technical design of robots called appropriately *Robot Evolution*. In this work he began to lay out his theory of Leonardo's designs for programmable automata that have recently been summarized in his 2006 book *Leonardo's Lost Robots*. One of the main elements of Rosheim's thesis is his reconstruction of a machine in the *Codex Atlanticus* that was originally interpreted as a spring driven cart (*Codex Atlanticus*, Folio 812r/folio 296v.a) but has been reconstructed as a programmable automaton by Rosheim. He also couples this machine with a pulley system and cam mechanism drawn in another folio in *Codex Atlanticus* (Folio 579r/folio 216v.b) and speculates that the combined systems that could have moved and operated the arms of a moving knight (see Figure II.46).

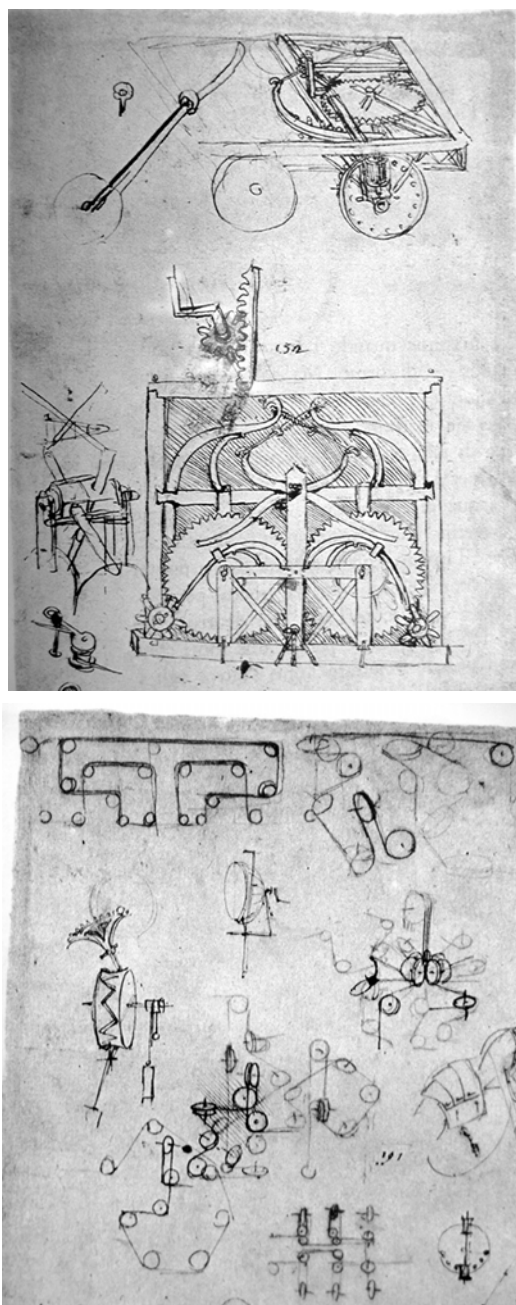

Figure II.46. Automaton cart and possible automaton pulley system of Leonardo da Vinci (Codex Atlanticus; upper Folio 812r/folio 296v.a; lower Folio 579r/folio 216v.b)

Rosheim argues that the spring-loaded cart is really a clock escapement coupled to a programmable cam and this mechanism could have been used with the pulley system to construct a walking lion or a moving knight. What makes his thesis plausible is that Rosheim has actually built such a programmable moving cart that has been demonstrated on a popular show for the BBC. Assuming that Leonardo intended to connect all these disparate elements into an automaton, the question arises as to whether his accomplishment was singular for his time and whether this work had impact on later generations of automata and robot designers? Three of the subsystems from Leonardo's *Codex Atlanticus* are shown in Figure II.46. It is clear that there is not really a lot of detail to conclude that these elements were the source for Leonardo's 'robotic' lion or moving knight. But given the context of Leonardo's technical world, it is quite plausible that he could have designed such machines.

The origins of automata have roots in Greek and Roman antiquity. Hero of Alexandria had designed moving figures using water and falling weights as power sources (Mayr, 1969). In one such description of these automated theatres, a three-wheeled cart (not unlike Leonardo's in *Codex Atlanticus*), bearing a statue of Bacchus moved by itself, stopped and shot out a flame; steamed wine then flowed from a goblet onto a crouched panther, after which the cart and statue returned to its starting point.

During the Middle Ages there appeared a book by three brothers Banu Musa of Baghdad, that contained designs for different water driven automata. A later book by Al-Jazari in the 13th century also contained designs for automated kinematic figures of birds and animals driven by water. The work of Vitruvius mentioned earlier in this book cited the water clocks of Ctesibius and the famous Su-Sung Chinese clock of the 11th century each of which had regulated motions using principles of hydrodynamics. In the famous sketchbook of Villard de Honnecourt (c. 1225) there is a drawing of a mechanized eagle that could move its head.

The development of the mechanical escapement, the so-called verge and foliot in the 13th and 14th centuries, laid the foundation of the development of automata for the next six centuries. Tower clocks were built that not only told the time but also rang bells and were designed to move linked mechanisms representing animals and humans. The famed Strasbourg Cathedral has a clock mechanism dating to 1352 that had three kings bowing and a crowing cock. The Nürnberg clock of the Marienkapelle [1356–1361] had seven moving princes bowing before an image of the Emperor. Another fa-

mous example is the glockenspiel of the old Rathaus in the main square in Munich with animated figures.

In his classic book *Puppets and Automata*, Max von Boehn (1932) described the traditions of automatic clock figures as well as the use of human animated puppets for shows in the Italian *commedia del l'arte* genre of theatre. These plays often involved the fighting of knights and Saracens, as well as dragons. In Roman times, it was common for giant puppets with movable jaws to be paraded about. In France in the plague years 1456–1460 giant figures were paraded in the cities along with dragons set in motion by concealed men. The tradition of parading a larger than life size dragon has been preserved today at Cornell University where on St Patrick's Day, architecture students build and march through the campus with a fire-breathing, head-moving colorful dragon, of some 10–30 meters long, that is eventually burned on the old quad.

A near contemporary of Leonardo da Vinci, the mathematician Girolamo Cardano [1501–1576] wrote in his treatise *De Varietate Rerum*, of observing two Sicilians performing a one-string, two-puppet show:

They made the most astonishing movements with their feet, legs, arms and head – all with such varied gestures that I am unable, I must confess, to render an account of such an ingenious mechanism.

Cardano's name is often associated with the universal joint a gimbal-like mechanism also found in the manuscripts of Leonardo. The Italian marionette theatre was so famous, a theatre was set up in London which apparently made an impression with Shakespeare.

The conclusion here is that the use of moving, linked figures in the Renaissance was a common observation in Leonardo's time and it would not have been unusual for him or other artist-engineers to be able to construct such animated figures whether moved by men or moved by machine. The technical environment in which Leonardo da Vinci lived contained many of the basic elements to conceive of an automata-like machine, such as gearing systems, clock escapements or spring-energy storage similar to those in cross-bows, catapults and balistica. Although Leonardo had the genius to draw all of these basic machine elements in his manuscripts, it is speculation to say he intended to combine them into more complex machines such as robots or automata that did not explicitly appear in his drawings. After all, in our opening section, Section I.2, 'Leonardo in Your Toothbrush' it was shown that many machine elements in modern motorized toothbrushes can be found in Leonardo's manuscripts. But no one will claim Leonardo invented these toothbrushes.



Figure II.47. Modern Japanese Tea-serving Doll automaton (courtesy of S. Shiroshita, Museum of Kyoto University)

Though Rosheim's theory on Leonardo's automaton three-wheeled cart may be plausible this does not extend to his further theories that Leonardo's drawings may have influenced the design of Japanese tea-serving automata called a *Karakuri* doll that appeared in the 17th century (Figure II.47). Rosheim also makes the claim that the bio-mechanical studies of the human body by Giovanni Borelli [1608–1680] such as *Moto Animalium* (1680), 'on the motion of animals' were copied from Leonardo's missing pages of Leonardo's *Codex Madrid* (c. 1500). These speculations fall under the 'genius theory' of scientific and technological progress. Under the evolution theory Leonardo's interest in automata would be part of the continuum of advances in this field originating from the Greeks to the Arabs.

It is useful here to distinguish between the terms 'automaton' and 'robot'. Robotics today is a subfield of *Mechatronics* (a name coined by a Japanese firm a quarter century ago) and is the marriage of kinematics, electronics and computer science. Today many machines are called robotic, even controlled vehicles, microwave ovens, vacuum cleaners and cameras. However although these devices exhibit some degree of computer control, their basic geometric configuration does not change. A robot can be defined as *a programmable*

machine consisting of a collection of mechanical bodies, which can make significant changes in its configuration, is able to move in a workspace in response to feedback from sensory data from both the machine and its environment.

Using this definition, Leonardo's automated cart (Figure II.46), even if it is programmable, did not have any ability to correct its behavior in response to sensory feedback from its environment. Also the moveable cart is at most a programmable vehicle, since its geometric configuration does not change very much. Coupled with the pulley-actuated arms for a movable knight, this machine would have had elements of a modern robot, but still would have lacked feedback control to change its motion in response to its environment. Automata of the 18th century such as dolls that could write were programmable machines and not robots. Jacquard's loom, in 1801, with punch card programs to create different designs in the cloth did not constitute a robot. Many scholars agree that one of the first feedback-controlled machines was James Watt's speed control rotating ball mechanism (see e.g. Mayr, 1969).

The original use of the word robot was by the Czeck playwright, Karel Capek in his 1920 play *Rossum's Universal Robots*, performed in English in New York in 1922. In the opening lines of the play, the factory manager is explaining to a visitor how a young engineer named Rossum invented the mechanical worker; the human was too complicated he said, so Rossum reduced the robot to only essential parts:

Young Rossum invented a worker with the minimum of requirements. – He rejected everything that did not contribute directly to the progress of work – everything that makes man expensive. In fact he rejected man and made the Robot. – the Robots are not people. Mechanically, they are more perfect than we are, they have an enormously developed intelligence, but they have no soul.

As automated machines have evolved so has the terminology. *Automata* was used before the 19th century as was the term escapement mechanism. In the 19th century with the emergence of Watt's steam engine the term *regulator* was used, especially with speed control of prime movers. Reuleaux's 1893 book *The Constructor*, contains many drawings of valve regulators. Later in the early 20th century, with new electric motors and electronic tube circuits, the term *servo-mechanism* was used. *Automation* was another term in the popular press in the wake of Henry Ford's perfection of the automated factory, although its origin might go back to Oliver Evans' automated grain mill of the late 18th century. In the post WWII era *cybernetics* was a hot term and cybernetic machines and art such as the cybernetic towers of Nicholas

Schöffer, were in vogue. Aside from Karel's 1920 play, the widespread use of *robotics* appeared with both motion picture films as well as the first industrial robot machines of Joseph Engelberger. With the evolution of aerospace engineering, the term *control theory* became popular and remains so today, but has competition from the term *mechatronics* as well as intelligent machines, artificial intelligence and smart machines.

The first robotic manipulator arms for industrial use were made by Unimation Inc. in 1961. By 1980 there were 3000 Unimates in service. Joseph Engelberger, one of the pioneers of modern robotics writing about industrial robots in 1980, gave a definition by the Robot Institute of America;

a robot is a reprogrammable, multifunctional manipulator designed to move material, parts, tools or specialized devices, through variable programmed motions —.

Engelberger added the following:

One feature [a robot] must possess if it is to rank as a robot is the ability to operate automatically on its own. This means that there must be inbuilt intelligence —.

Two terms in the above definitions, 'reprogrammable' and 'inbuilt intelligence', had their origins in kinematic mechanisms in the 19th century. One mechanism was the cam that could be shaped to move a linkage as the cam rotated. Thus information was stored in the shape of a rotating cam sometimes used in the control of engines. Digital mechanical storage of information took the form of punched cards as in Jacquard's textile machines. Mechanical 'intelligence' took the form of logic mechanisms in which the output motion depended on one or more actions of other machine elements. Mechanical logic elements were regularly used in the 19th century in mechanical calculators for the 'tens-carry' mechanisms (Moon and Lipson, 2007). They were also used in clock bell ringing mechanisms.

The path of evolution of automated machines from the automaton cart of Leonardo and the glockenspiel clocks of the Renaissance to modern robotic and mechatronic devices had several branches (see e.g. Koetsier, 2001b). One branch was the development of precision watch and clock-making. Another path to robots was the evolution of automated toys, textile machines and calculators. A far different path was the design of control systems for steam engines. The first branch led to the development of precision machining technology. The second led to the concept of stored information and programmed machines. The third branch led to analysis methods for designing stability and control dynamics of machines.

CLOCKS AND ESCAPEMENTS

Most historians place the invention of the mechanical clock escapement around the 13th–14th century. The verge and foliot escapement clock at Salisbury Cathedral in England for example dates from, 1386. The original escapement did not have a pendulum or spring and balance wheel to fix the frequency, and the period depended on the friction in the machine. The verge consists of two paddles fixed to an axle that interacts with the ‘scape’ wheel. The foliot is a bar with weights that acts as an inertial element or angular momentum storage. Without a spring attached to the foliot however there is no natural frequency except that determined by friction. Leonardo has several drawings of verge and foliot mechanisms in his *Codex Madrid* (see Figure III.12a).

The first pendulum clock is attributed to Huygens in 1657, although there was some posthumous claim to the invention by Galileo’s son. The Huygens clock is a combination of the verge and the pendulum. Huygens recognized that the period of the pendulum increased with the amplitude and designed a cycloidal clamp for the pendulum which decreased the effective length of the swinging bob to produce a constant period independent of amplitude.

The next major improvement was the invention of the *anchor escapement* that replaced the verge with a two-arm device. This invention is often attributed to Robert Hooke but other sources give credit to a clockmaker William Clement in 1670. The anchor, like its predecessor the verge, served to regulate the amount of energy or torsional impulse imparted to the pendulum from the falling weight in each cycle. One fault of this device was the recoil that occurred when one of the two anchor pallets impacted the escape wheel teeth. This was corrected by the invention of the so-called *deadbeat escapement* invented by clock and instrument maker George Graham in 1715. This improvement redesigned the shape of the anchor pallet arms as well as the escape wheel so as to prevent recoil on impact. These design improvements greatly increased the precision of clocks. Contrary to popular belief, the motion of a clock pendulum, coupled to an escapement that regulated the energy input, did not produce accurate nor regular motion.

Many readers are familiar with the pioneering work by the English clockmaker, John Harrison [1693–1776] on the design of accurate clocks for marine travel and their use in the determination of longitude (Sobel, 1998). Without listing all the improvements that he made, clock accuracy went from seconds per day to seconds per month during the Harrison dynasty. Other contributors at this time were Pierre Le Roy and Ferdinand Berthoud of France as well as Arnold and Earnshaw in England. Also many other escapements

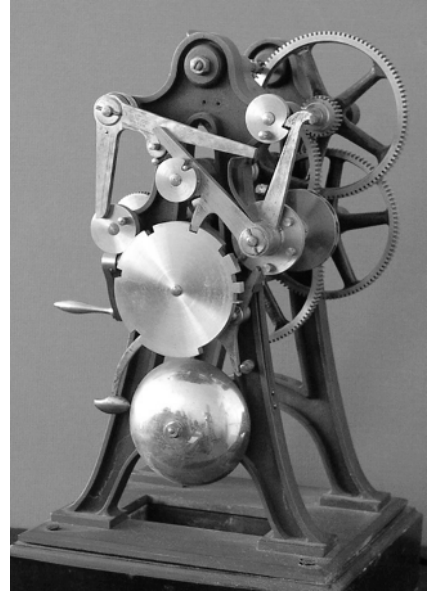
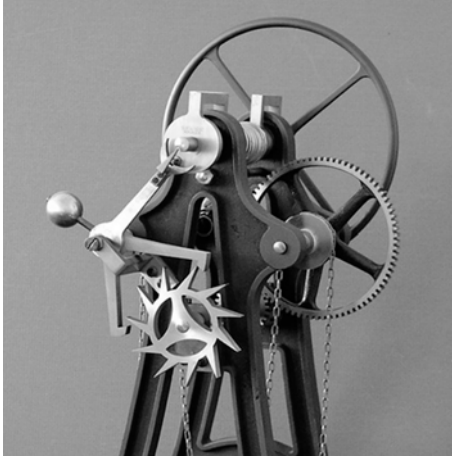

Figure II.48. Clock and bell-ringing mechanism models of Reuleaux (Cornell Collection of Kinematic Mechanisms)

were invented such as the detent, cylinder, duplex, pin wheel, and gravity escapement, the last of which was installed in the clock tower in London known as Big Ben in 1859, a period of over four centuries of invention, design and development (see Figure II.48). (Some of these escapements are illustrated in the Reuleaux kinematic models and can be seen on the website KMODDL under the Voigt X model series.) Although escapements were truly dynamic mechanisms, whose operation depended on both Newton's laws of motion as well as the kinematic constraints, detailed dynamic analyses of clocks did not appear until the 20th century (see Moon and Stiefel, 2006).

DOLLS, DUCKS AND CALCULATORS

Jacques Vaucanson [1709–1782] is known for two machine technologies, an improved textile loom and his incredible automata. In 1738, Vaucanson displayed his mechanical flute player and a mechanical duck in Paris (see the book by Wood, 2002, *Living Dolls*). The life-size flute player was able to play twelve songs. The duck walked, flapped its wings, swam in water and ate food, not to mention defecating the remains. The duck outlived Vaucanson into the 19th century, passed from one owner to the next before it deteriorated. Vaucanson built a wooden clock as a child and later learned to build special

machines to fabricate his automata. This illustrates one difficulty Leonardo would have had in realizing any designs for precision automata, namely that before the age of mass-produced accurate machine elements, the building of a machine depended on the creation of special machine tools.

Thirty-five years later, in 1773 father Pierre Jacquet-Droz and son Henri-Louis built a writing doll called a 'scrivener'. The doll could be programmed to write several messages. A version of this type of automaton can be seen in Beijing's 'Forbidden City' Museum in which a mechanical scribe can be programmed to write in Chinese characters. In 1783 father and son introduced a 'draughtsman' that could be programmed to draw a sketch. In one such exercise the machine drew an image of King Louis XV. They also developed a mechanical piano player. All three machines were on display at one time in the Museum at Neuchatel (Eco and Zorzoli, 1963). The designers of these machines not only delighted observers with their performance but also showed how it was possible to tightly package a complex assembly of many precise mechanical parts. This combination of complexity and small packaging was also underway in the development of watches, in which hundreds of parts could be placed in working order in a small case to be pinned on a women's blouse or placed in a man's vest pocket. The limit of this downsizing has continued today with the electronic microchip and the MEMS electro-mechanical device.

Vaucanson's contributions to textile machines, in the 18th century began the evolution of the punched card information storage system used in changing the weaving of multi-colored threads into cloth. A French engineer named Falcon is credited in 1728 with the first attempts in this area. Vaucanson later improved the textile programming system. In 1800, Joseph-Marie Jacquard produced a silk brocard loom for weaving pictures into textiles that became a widely used industrial machine. It may be coincidental but Vaucanson and Leonardo both worked on the design of textile machines and automated machines. The punch card system of information storage was later tried in Charles Babbage's abortive attempt to build an automatic computing machine in 1843, called the 'analytic engine'. In 1842, Babbage displayed to invited guests in his home in London, an amazing 'painting' of J.M. Jacquard that was really a woven reproduction used in a Jacquard loom with 24,000 card instructions (Essinger, 2004).

The roots of mechanical calculators go back to Blaise Pascal [1623–1662] and Gottfried W. Leibniz [1646–1716]. Several Leibniz calculators were built based on the so-called stepped drum gear as well as a 'tens carry mechanism'. These were digital machines and by the 19th century they could be used to

add, multiply, subtract and divide. One of the most successful in the early 19th century was built by Thomas de Colmar called the ‘Arithmometer’. Several thousand of these machines were made in the 19th century. One of the only descriptions of the tens-carry mechanism, is found in a small monograph by Franz Reuleaux (1862) (Figure II.33). See also Moon and Lipson (2007) for a modern analysis of the Thomas tens-carry mechanism and Reuleaux’s paper. Forming another link in the evolution of machines, Babbage’s work on a symbolic language for the functioning of a machine influenced Reuleaux’s own theory of a symbolic language for machines.

GOVERNORS, SERVOMECHANISMS AND CONTROL THEORY

The two principal historical texts in this area are Otto Mayr’s *The Origins of Feedback Control*, (1969) and S. Bennett’s *A History of Control Engineering 1800–1930*, written in 1979. Mayr’s work covers the period from antiquity to around 1800. Many writers credit James Watt with the invention of the rotating ball regulator in 1788 to achieve speed control of the steam engine. However Mayr cited earlier use of the rotating ball governor for control in windmills by Mead around 1787. The rotating ball controller device was described and drawn in the machine encyclopedia of Borgnis (1818). Many authors in machine design at this time wrote an equation of balance of centrifugal acceleration forces for dynamic equilibrium for the ball governor but did not consider its stability in a machine. It was James Clerk Maxwell, of electromagnetics theory fame, who derived differential equations of motion based on Newton’s laws of motion and established stability criteria for steam engine governors and similar dynamic devices.

In reading Maxwell’s 1868 paper, which was published in the Proceedings of the Royal Society, there are no sketches or pictures of any governor mechanisms. There is reference to several governors of Watt, Jenkins, Siemens, etc., but Maxwell’s analysis uses general abstract terms to describe forces or torques in these machines; but no specifics. He obtained a dynamical system of differential equations coupling the governor dynamics to the machine or ‘plant’ motions and thus found a stability criterion for the controller to avoid instabilities. Although his mathematical models have some generality, it is not clear if they apply to actual devices since none of the parameters are estimated by Maxwell. Bennett (1979) suggested that this control problem of Maxwell arose out of an attempt to design an experiment to measure resistance accurately that required the speed control of a rotating device. There is also a hint in Maxwell’s paper that there was anecdotal evidence for engine instabilities with governors as Maxwell calls it, “*oscillating and jerking*

motion, increasing in violence until it reaches the limit of action of the governor”.

It is interesting to note that Maxwell [1813–1879] was educated at Trinity College, Cambridge in 1850 and became a Fellow of Trinity in 1855 at a time that Robert Willis [1800–1875], the great kinematician was teaching there. Willis was appointed Jacksonian Professor of Natural Philosophy in 1837. In 1841 Willis had published his book *Principles of Mechanism* and published a second edition in 1870. Maxwell was appointed first Cavendish Professor of Experimental Physics at Cambridge in 1871, four years before Willis died. However there is no evidence of any knowledge or interest by Maxwell in Willis’ scientific papers on mechanisms. He published his famous treatise on electricity and magnetism in 1873 and one presumes that Maxwell’s greater interest was in this subject and the theory of gases rather than in the dynamics of machines. Also Cambridge University did not have an engineering Tripos exam until 1875, after Willis’ death.

Maxwell and others such as E.J. Routh and the Russian work of A.M. Lyapunov laid out the ideas of stability of motion in mechanical and electrical systems by the end of the 19th century. It is interesting to note that Lyapunov was a student of Chebyshev at St Petersburg. The latter had spent many years analyzing the kinematic geometry of linkages and mechanisms including walking mechanisms.

As outlined in Bennett (1979), the use of speed controllers in the 19th century, evolved into the field of servomechanisms. Initially both feedback and control actuation were accomplished with mechanical linkages but were gradually replaced with electromechanical sensors and actuation in the early 20th century. However, the teaching of control theory in the late 20th century was often devoid of specific machine knowledge with exceptions in gyro design and aircraft control in which detailed knowledge of the machine was part of the control culture. In modern robot technology the teaching of feedback control with mechanism knowledge began in the late 20th century as in the text by Craig (2005). To this day however with very few exceptions, the combined teaching of control dynamics and mechanism and machine design has largely been missing in texts.

In summary it is interesting to speculate on Leonardo’s designs for automata in the Renaissance or note Watt and Reuleaux’s interest in machine regulation in the Industrial Age. But the path to robotic-like machines has been a slow evolutionary process with several branches including clocks, automata, regulators and calculators. In the early 21st century, the use of fully controlled, intelligent machines has still not reached its potential as measured

by the imagination of science fiction writers and young engineering students. As machines have evolved, so has humankind's acceptance of the machine into their daily lives. However when machines and computer intelligence are fully integrated, as will surely happen in the near future, will we be ready to fly in pilotless aircraft or ride in cars without manual controls?

II.22 LEONARDO AND REULEAUX: A SUMMARY

CHEERING FOR LEONARDO

Studies of the machines of Leonardo da Vinci have had at least three camps; (i) those who see him as a genius and view his designs as prescient precursors of our current technology, (ii) those critics who claim his drawings simply reflected the technology of his times and earlier machine books and (iii) a few who think Leonardo was the best of a cadre of machine designers of his day. The scholarly work on da Vinci's painting and art by Kenneth Clark certainly falls in the cheerleader group as does Reti and Dibner. In the critics group we have Duhem and Truesdell and perhaps Gille. Straddling this group is the work of Paolo Galluzzi (1991, 1997) of the Institute and Museum of the History of Science in Florence, whose recent work on the Renaissance engineers of Siena highlighted the work of Francesco di Giorgio. The present book has also tried to steer this middle course with the thesis that in an evolutionary process, many paths and links are necessary for transmittal of technical knowledge including the genius of both the scientist-mathematician and engineer-architect as well as the genius of ordinary skilled craftspeople making incremental improvements one machine at a time.

In Part III of this book we outline a detailed comparison of the basic components of machine design as described by Leonardo da Vinci and Franz Reuleaux. Before looking at Leonardo and Reuleaux's machine mechanisms, we summarize our overall view of their accomplishments as machine engineers as well as compare the two 'Machine Ages' of the Renaissance and the Industrial Revolution.

Both Leonardo and Reuleaux advanced in their careers in times of dramatic changes in the economic, social structure, scientific and technical milieu of their times. Florence was at the vanguard of new ideas that challenged the traditional Church views of mankind's role in the world. In both Florence and Milan, Leonardo met and worked with artists and artisans of exceptional skill and breadth as well as architects, engineers and mathematicians. By the end of the 15th century there were reports from Italian explorers of new lands and peoples. While science and medicine was still tied to the old theories of Aristotle and Galen, awaiting the new constructs of Copernicus and Galileo, the idea of building knowledge on experience and experiment had gained a strong footing and Leonardo was its champion.

Reuleaux's professional years were also lived in times of dramatic change on a scale even greater than Leonardo's. By the 1870s, the first 'internet' had arrived and had linked four continents with the telegraph. The rise of

steam power created transportation networks on land and sea that produced a generation of ‘steam-setters’; wealthy and powerful people who traveled the globe bringing ideas and fashions from different parts of the world to both Europe and North America. Leading this change in Europe was Germany and Berlin, who by the late 19th century was replacing England as the industrial leader.

Both engineers lived different lives, were educated differently and came to the design of machines by different paths. Leonardo was trained in the artist-craftsman tradition having but a smattering of mathematics training and knowledge of the works of Archimedes, Hero, and Vitruvius. Reuleaux was of a new generation of engineers trained in a polytechnique university with additional education in philosophy and science. As Leonardo had an apprenticeship in the workshop of Verricchio, Reuleaux had workshop training in the machine factory of his uncle. Eventually each was working outside the workshop and guild traditions of their times. One has to especially admire Leonardo’s accomplishments since the concept of ‘progress’ and advancement of technology was just emerging from the suffocation of the Church view of life as a way station to heaven. Although technology, progress and Western optimism for technological advancement was in full swing in the 19th century, Reuleaux’s passion for the role of science and mathematics as essential to the design of machines and technology was not fully integrated into the education of engineers. Reuleaux had harsh critics in Germany who took every opportunity to publicly protest his emphasis on theory and mathematics in technical education.

Both Leonardo and Reuleaux were advisors to powerful leaders. Leonardo da Vinci advised the Duke of Milan for nearly 18 years while Reuleaux was a Royal Councilor to the Kaiser’s government, a member of the Patent Board and was on working terms with men like Siemens, Otto and the Mannesmann brothers. As engineering advisors to power they were respected, but as large-project engineers they had less success; e.g., Leonardo’s failed bid to divert the Arno river so that Florence could defeat Pisa and Reuleaux’s backing of a hollow-pipe industry by the Mannesmann brothers to create a gas energy network in Europe. Instead they excelled in their vision of the *Machine*; a creation spawned of need and imagination, art and industry. They posited the idea that creating a new machine was of the same caliber as creating a new building and that this art was based on principles akin to those architecture, mathematics and the basic sciences.

Linking Leonardo’s and Reuleaux’s ideas and designs is an unbroken evolutionary network of designing and building machines, originating in the an-

cient civilizations, codified by the Greeks and transmitted to the emerging European Renaissance culture by the Arab and Moslem civilization of the Middle Ages (Figure II.44). Both Leonardo and Reuleaux made considerable contributions to this machine design tradition. They were the recipients of a technical culture based on both written and workshop knowledge systems. These global technical networks stretched largely from Europe to Asia in the Renaissance and from North America to Europe in the Industrial Age. Although the specific machines and technologies were important, we have emphasized in this book the historic role of the development of a methodology for inventing, designing and producing machine technology. For both Leonardo and Reuleaux the skill of precision machine drawing was of great importance. The use of geometry and kinematics or the 'geometry of motion' as well as algebraic relationships, were essential tools of the machine designer.

In both traditions of machine design, the dynamics aspect of machines was little understood, and did not make its appearance until the early 20th century. While dynamic and thermodynamic principles had little impact on their designs for machines, both engineers took an interest in machine regulation and control. Leonardo da Vinci made many designs of components for clocks. He also drew machines that automated two or more processes for manufacturing textiles and metalworking. Franz Reuleaux also showed a fascination with regulated machines, especially in his later years. Mechanical feedback control would be eclipsed with the electronic and microprocessor revolution a century later and *mechatronics* would become the hallmark of machine design in the late 20th and early 21st centuries. But here again, automated machines and automata had origins and sources spanning the Greeks to the Industrial Age.

Contrary to the romanticized image of machine creation, most machine advances evolved from earlier concepts and were motivated by economic needs and opportunities. Leonardo and Reuleaux both acted under similar pressures and incentives, textile manufacturing and warfare in Renaissance Italy and transportation and manufacturing production in the 19th century.

Both Leonardo and Reuleaux had a concept of invention and believed that there is a rational basis for invention, an idea that is still in question in our own time. Neither seemed to find a need to romanticize invention, but saw it as a natural consequence of meeting the needs of a client. Both men saw a natural relationship between the process of inventing machines and creating art, an idea that challenges the 'Two Cultures' beliefs of our own time.

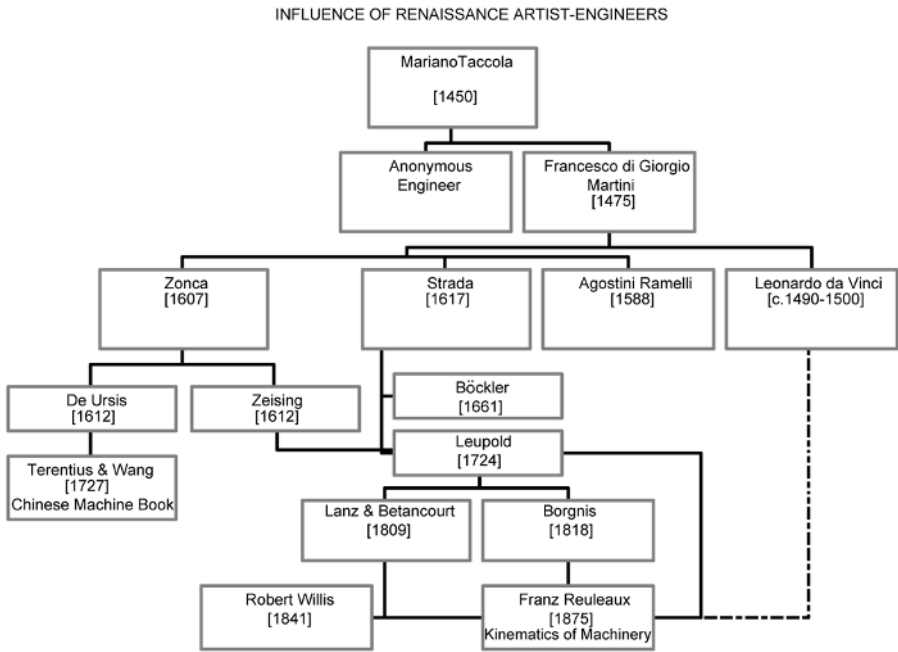
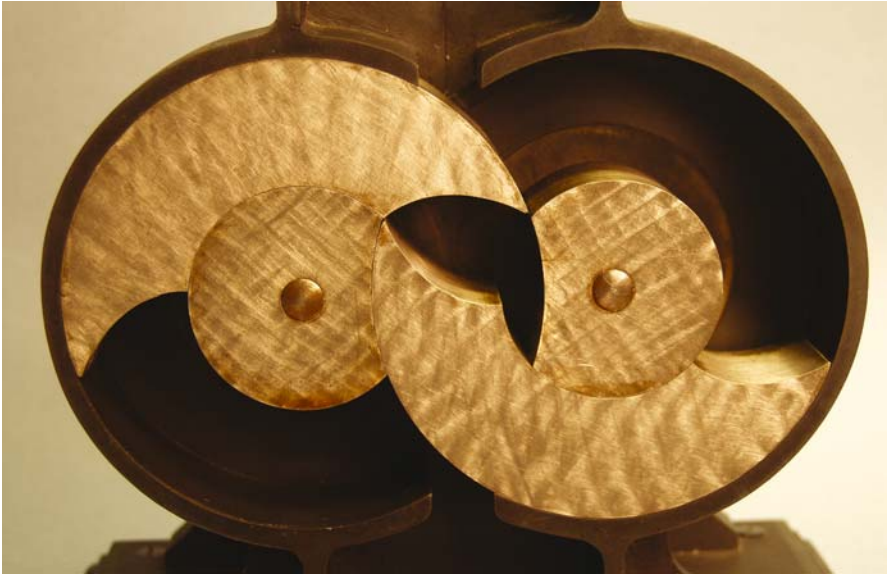

Figure II.49. Chart of Influence of Renaissance Engineers after Reti (1963)

Finally, one shared aspect of Leonardo and Reuleaux’s lives was the popularity of each personality in their times and their fall from importance before and after their deaths, only to rise again in recognition of their accomplishments a century or more later.

COLOR PLATES



Color Plate 1. Close-up of positive displacement pump of Dart. Reuleaux–Voigt Model I-7, Cornell University Collection of Kinematic Models, nickel-plated brass and cast iron, Berlin, circa 1882 (Photo, F.C. Moon)



Color Plate 2. Clemen's universal joint coupling. Reuleaux–Voigt Model P-3, Cornell University Collection of Kinematic Models, nickel-plated brass and cast iron, Berlin, circa 1882 (Photo, F.C. Moon)



Color Plate 3. Geneva-wheel intermittent mechanism for watches. Reuleaux–Voigt Model N-8, Cornell University Collection of Kinematic Models, nickel-plated brass and cast iron, Berlin, circa 1882 (Photo, F.C. Moon)



Color Plate 4. Close-up of ratchet-wheel coupling. Reuleaux–Voigt Model N-7, Cornell University Collection of Kinematic Models, nickel-plated brass and cast iron, Berlin, circa 1882 (Photo, F.C. Moon)

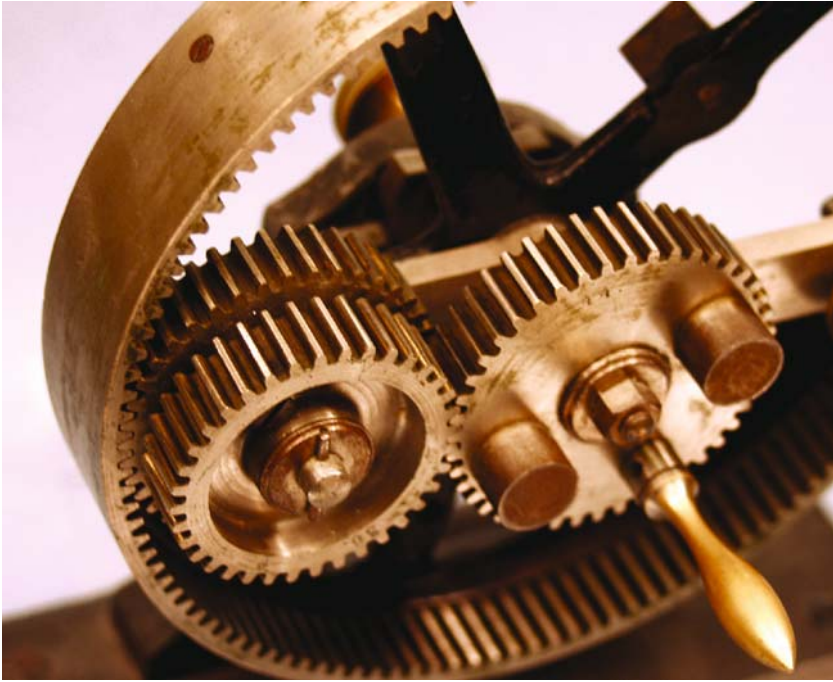

Color Plate 5. Close-up of planetary gear train. Reuleaux–Voigt Model G-3, Cornell University Collection of Kinematic Models, nickel-plated brass and cast iron, Berlin, circa 1882 (Photo, F.C. Moon)

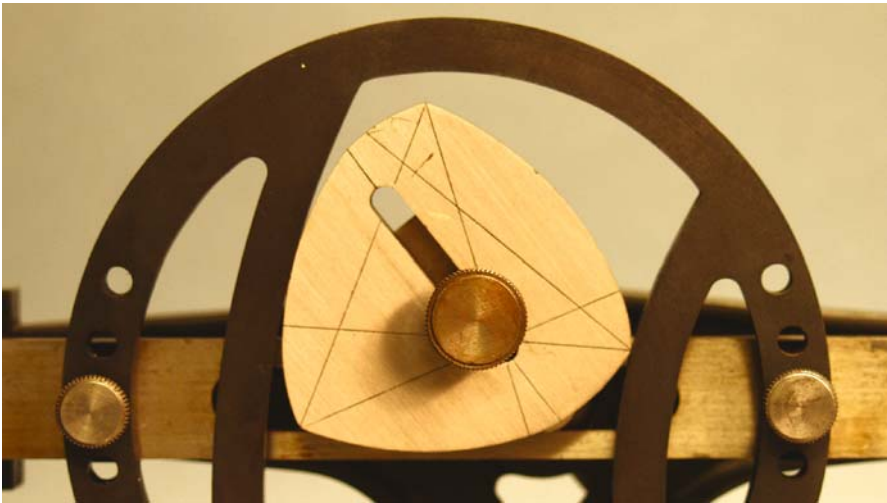

Color Plate 6. Positive-return cam with Reuleaux triangle. Reuleaux–Voigt Model L-6, Cornell University Collection of Kinematic Models, nickel-plated brass and cast iron, Berlin, circa 1882 (Photo, F.C. Moon)



Color Plate 7. Spiral positive-displacement pump. Reuleaux–Voigt Model I-4, Cornell University Collection of Kinematic Models, nickel-plated brass and cast iron, Berlin, circa 1882 (Photo, F.C. Moon)

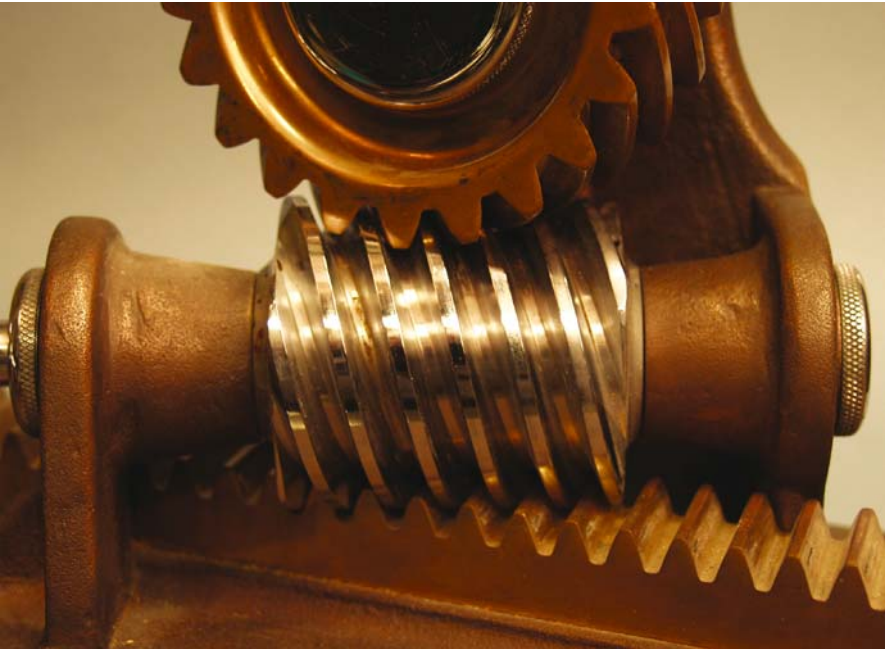

Color Plate 8. Worm gear and rack. Illinois Gear Corp. Model, Cornell University Collection of Kinematic Models, brass and cast iron, Chicago, circa 1950 (Photo, F.C. Moon)

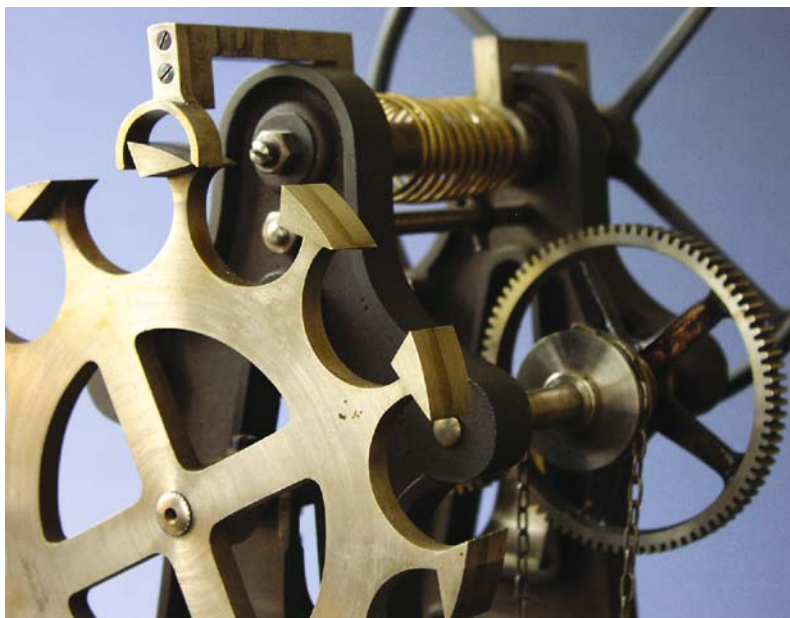

Color Plate 9. Close-up of cylinder escapement for a clock. Reuleaux–Voigt Model X-3, Cornell University Collection of Kinematic Models, nickel-plated brass and cast iron, Berlin, circa 1882 (Photo, F.C. Moon)

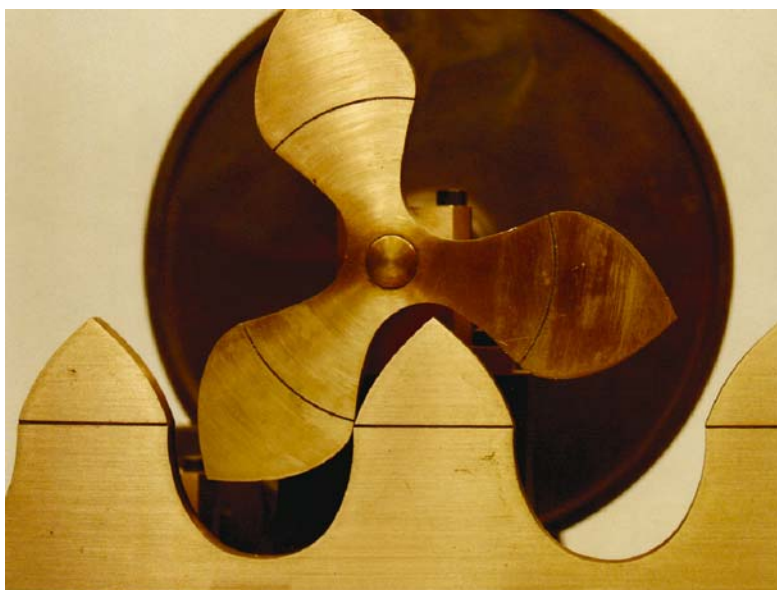

Color Plate 10. Close-up of gear teeth for rack and pinion mechanism. Reuleaux–Voigt Model Q-1, Cornell University Collection of Kinematic Models, nickel-plated brass and cast iron, Berlin, circa 1882 (Photo, F.C. Moon)

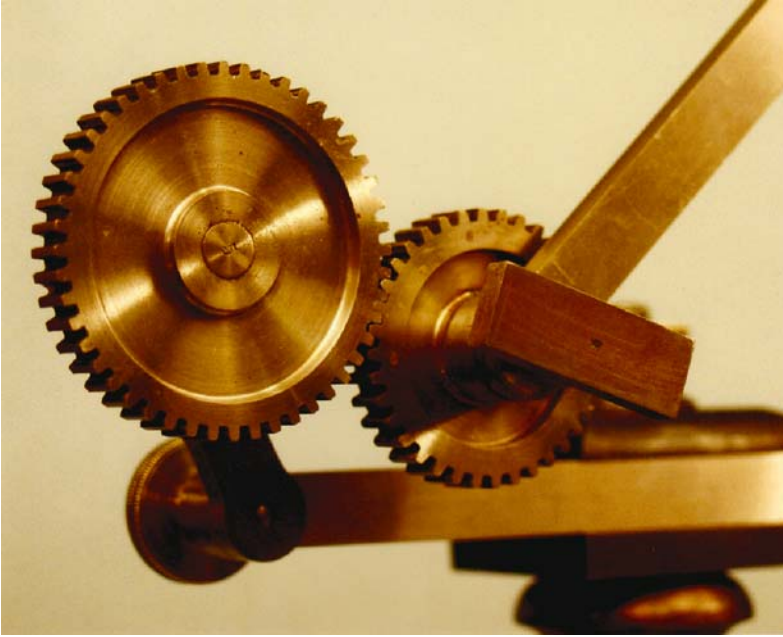

Color Plate 11. Planetary gear and four-bar linkage. Reuleaux–Voigt Model O-1, Cornell University Collection of Kinematic Models, nickel-plated brass and cast iron, Berlin, circa 1882 (Photo, F.C. Moon)

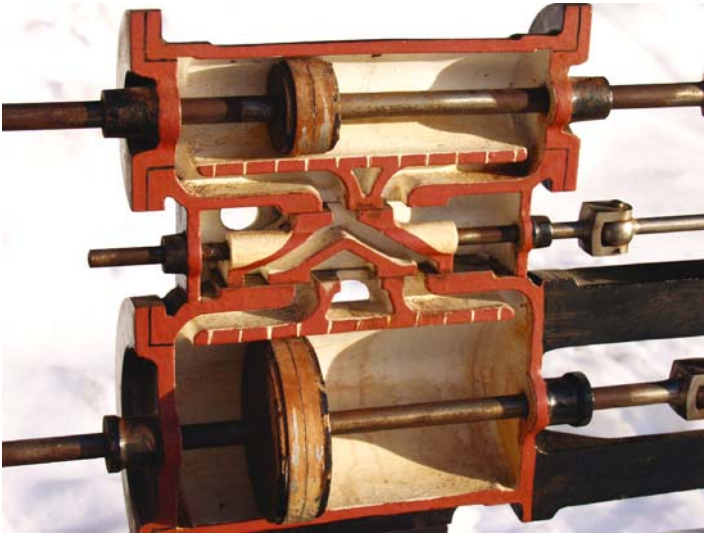

Color Plate 12. High and low pressure valve mechanism for a steam engine. Schröder Model, Cornell University Collection of Kinematic Models, brass and cast iron, Darmstadt, Germany, circa 1870–1880 (Photo, F.C. Moon)

PART III

Comparison of the Kinematic Mechanisms of Leonardo and Reuleaux

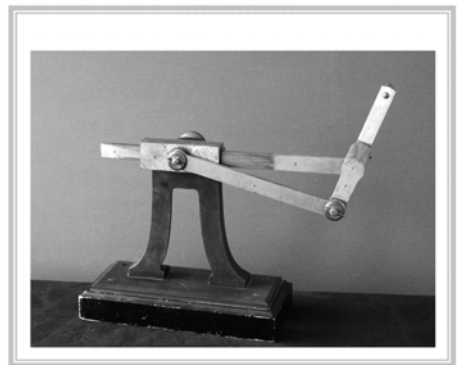
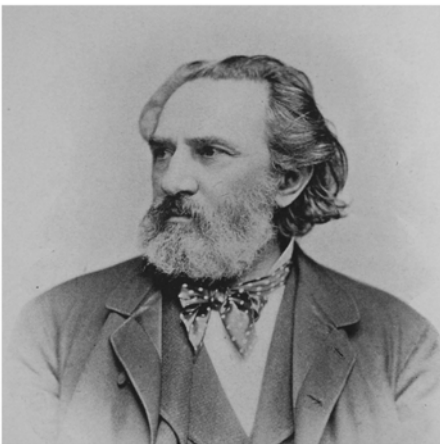
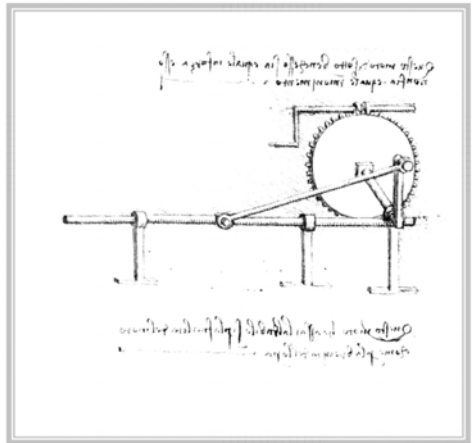

Leonardo da Vinci:

“It is customary to oppose the violent motion of the wheels of the clock driven by their counterweights with certain devices called escapements, as they keep the timing of the wheels which move it. They regulate the motion according to the required slowness and length of the hours. The purpose of the device is to lengthen the time, a most useful thing.”

[*Codex Madrid I*, Folio 115 verso; transl. L. Reti.]

Franz Reuleaux:

“As for escapements of clocks and watches, these have been sent hither and thither, now in mathematical text books, now in kinematics, now in applied mechanics, again in encyclopedias, where their fundamental principle has been entirely lost, their intimate relation to the ratchet mechanism being hardly noticed. – Many readers – may shake their heads at this statement, but an examination will show the action of the piston engine is similar in principle to a watch escapement, the action of the slide valve being practically identical with the anchor of the escapement.”

[*The Constructor*, 4th Ed., p. vi; transl. H.H. Suplee.]

III

Comparison of the Kinematic Mechanisms of Leonardo and Reuleaux

In Parts I and II, we compared the design methodologies of 15th and 19th century machine engineers through the work of Leonardo da Vinci and Franz Reuleaux. General comparisons of machines and mechanisms used in machine construction were made in Tables I.2, I.3, I.4 and Tables II.2, II.3. In particular we have started with the premise of the Leonardo scholar Ladislao Reti who compared Leonardo's '*elementi macchinali*' in the *Codex Madrid* and Reuleaux's '*constructive elements*' shown in Table I.3. In Part III we present a more detailed comparison of Leonardo's mechanisms in his manuscripts with the physical kinematic models of Franz Reuleaux. In this section we emphasize not just the machine elements of construction, but the elementary mechanisms that these elements are used to construct.

For example, in the slider-crank mechanism of a gas or steam engine, the basic machine elements include a piston and cylinder as a prismatic kinematic pair, the crank and connecting rod, the bearing pedestals and bearings and flywheel. This collection of machine elements forms a kinematic chain of parts with three revolute joints and one prismatic or sliding joint called a slider-crank. The recognition of the role that kinematic chains play in the design of machines was a significant contribution of 19th century machine theorists such as Robert Willis and Franz Reuleaux and distinguishes them from their Renaissance counterparts such as Francesco di Giorgio, Leonardo Da Vinci and Agostini Ramelli. Reuleaux defined six general classes of kinematic chains as represented in Figure I.3a: *crank chains*, *pulley chains*, *screw chains*, *ratchet chains*, *wheel* and *cam chains*. He also included non-rigid machine elements such as elastic springs. In modern machine design parlance this class is known as compliant mechanisms.

The *Codex Madrid* of Leonardo da Vinci contains many examples of ‘elementi macchinali’ or machine elements as compared to complete machines that can be found in some of his other codices. However the *Codex Madrid* also contains complete kinematic mechanisms. Reuleaux created a ‘dictionary’ of kinematic mechanisms in the form of 800 physical models of brass and iron, over 350 of which were reproduced in Germany. Cornell University has a collection of over 230 Reuleaux kinematic models manufactured by Gustav Voigt of Berlin in 1882. Our goal in this part is to compare the kinematic mechanisms in the *Codex Madrid* with the kinematic models of Reuleaux (Table III.2).

In the Voigt catalog of kinematic models, presumably written by Reuleaux himself, his six general classes of mechanisms are further divided into 25 categories as listed in Table III.1. Detailed names of the Reuleaux models in the original German are listed in the Voigt catalog digitized on the Cornell University KMODDL website.

In the section below, we compare some of the Reuleaux models with the sketches of machines and machine elements of Leonardo da Vinci. Table III.2 summarizes the basic elements in the *Codex Madrid* and the relevant Reuleaux models for comparison. In a few cases we also compare these elements with figures from Reuleaux’s books. Reti’s original tabular comparison is also included here for reference.

WEB ACCESS TO REULEAUX’S MODELS AND LEONARDO’S MACHINE DRAWINGS THROUGH KMODDL: KINEMATIC MODELS FOR DESIGN DIGITAL LIBRARY

Many of the Reuleaux models can be seen in motion on the KMODDL (Kinematic Models for Design Digital Library) website: <http://kmoddl.library.cornell.edu>. This website was created in 2004 and is maintained by the Cornell University Library. Today there are several kinematic model collections on the website:

- Reuleaux–Voigt models of the Cornell University Kinematic Models Collection,
- Clark models from the Science Museum in Boston,
- Redtenbacher Model Collection of Universitat Karlsruhe, Germany,
- Reuleaux models of Bauman Moscow State Technical University,
- Schröder Models of the Fondazione Scienza e Tecnica in Florence.
- Reuleaux models at the Deutsches Museum, Munich.

Table III.1. Catalog of Reuleaux kinematic models, Gustav Voigt Werkstatt, Berlin (1907)

Series	Description	Number of Models
A	Lower element pairs	3
B	Higher element pairs	4
C	Simple kinematic chains (including four-bar mechanisms)	9
D	Crank mechanisms (including slider-crank mechanisms)	14
E	Eccentric crank mechanisms	7
F	Crank chamber wheel mechanisms (fluid motors/pumps)	6
G	Compound wheel trains (gearing)	7
H	Vise stands to create inversions of four-bar linkage	2
I	Geared chamber wheels (pump mechanisms)	9
K	Angular double-sider chain	2
L	Cam drive of constant breadth	6
M	Screw mechanisms	9
N	Ratchet and intermittent mechanisms (including power escapements)	28
O	Planetary wheel chains	5
P	Hinged couplings (universal joints)	5
Q	Gear tooth profiles	8
R	Spherical cycloid rolling models	7
S	Straight-line mechanisms	39
T	Parallel guide mechanisms	14
U	Water-wheel paddle mechanisms	2
V	Belt guides	16
W	Friction wheel mechanisms	7
X	Clock escapements	12
Y	Reversing shift transmissions	20
Z	Clutches	7

After opening the KMODDL webpage, click on the Cornell Reuleaux Collection and a menu page will appear with a list of model categories similar to Table III.1 and the Voigt Catalog. When you click on one of the folders, a set of thumbnail photos will appear. Click on one of the photos and a full page for a model will appear with a description of the model. If there is a movie tab above the photo, then the still photo will be replaced with a movie image of the model in motion. Below the description is a set of resources related to the model such as references, tutorials and other movie images. Click on one of the movie images to obtain either a movie of the actual model or of a CAD representation of the model.

Table III.2. Comparison of Kinematic Mechanisms in Leonardo's *Codex Madrid* with Reuleaux's Kinematic Models (KMODDL)

-
1. **Four-Bar Mechanism:** *Codex Madrid I*, Folio 1r
Reuleaux–Voigt Model: C-1
 2. **Slider-Crank and Worm Drive:** *Codex Madrid I*, Folio 28v, 30r, 2r
Reuleaux–Voigt Model: C-2
 3. **Lazy Tongs – Pantograph:** *Codex Madrid I*, Folio 24v, 157v
Reuleaux–Voigt Model: T-2
 4. **Universal Joint and Gimbal Bearings:** *Codex Madrid I*, Folio 13v
Reuleaux–Voigt Model: P-1
 5. **Belt Drive:** *Codex Madrid I*, Folio 23r (also Folios 30v, 65v, 68v, 119r)
Reuleaux–Voigt Model: V-1
 6. **Endless Screw or Worm Drive:** *Codex Madrid I*, Folio 17v
Reuleaux–Voigt Model: C-9
 7. **The Screw Mechanism:** *Codex Madrid I*, Folio 26r
Reuleaux–Voigt Models: A-1, M-1
 8. **Double Helix Reversing Mechanism:** *Codex Madrid I*, Folio 15r, 30v
Reuleaux–Voigt Model: M-6
 9. **Pin-Teeth Rotary Reversing Mechanism:** *Codex Madrid I*, Folio 17r
Reuleaux Model: Deutsches Museum No. 06/62/78
 10. **Intermittent Mechanism – Geneva Wheel:** *Codex Madrid I*, Folio 7r
Reuleaux–Voigt Model: N-8
 11. **Ratchet and Pawl:** *Codex Madrid I*, Folio 117r, 12r, 97r
Voigt–Reuleaux Model: N-17, N-1
 12. **Verge and Foliot Escapement:** *Codex Madrid I*, Folio 61v, 115v, 9r
Reuleaux–Voigt Model: X-1
 13. **Pinion and Spur Gear Teeth:** *Codex Madrid I*, Folio 5r, 116r
Reuleaux–Voigt Model: Q-2
 14. **Rack and Pinion:** *Codex Madrid I*, Folios 13v, 35v
Reuleaux–Voigt Model: Q-1
 15. **Planetary – Epicyclic Gear Trains:** *Codex Madrid I*, Folio 13v
Reuleaux–Voigt Model: G-2
 16. **Bevel Gears – Conical Friction Wheels:** *Codex Madrid I*, Folio 96r
Reuleaux model, Deutsches Museum (Bevel friction wheels)
 17. **Friction Wheels:** *Codex Madrid I*, Folio 101v, 102r, 113v
Reuleaux–Voigt Models: Y-10, W-5
 18. **Cam Mechanisms:** *Codex Madrid I*, Folio 6v (also Folios 7r, 8r, 28v)
Reuleaux–Voigt Model: L-2 (Positive return cam)
 19. **Pump-Water Wheel:** *Codex Madrid I*, Folios 142r, 22v
Reuleaux–Voigt Model: I-7
 20. **Flywheels:** *Codex Madrid I*, Folio 114r
Reuleaux–Voigt Model: N-27 (Wheel accessory to N series)
-

Table III.3. Comparison of Machine Elements in Leonardo's *Codex Madrid I* and in Reuleaux's *The Constructor*, 4th edition (1893)

-
1. **Hinged Joints or Cylindrical Joints:** *Codex Madrid I*, Folio 172r
Reuleaux's *The Constructor*, 4th Edn. 1893
 2. **Ball and Pin Joints:** *Codex Madrid I*, Folio 100v
Reuleaux's *The Constructor*, 4th Edn., 1893
 3. **Pulleys:** *Codex Madrid I*, Folio 99r
Reuleaux's *The Constructor*, 4th Edn., 1893
 4. **Pulley Systems:** *Codex Madrid I*, Folio 155r
Reuleaux's *The Constructor*, 4th Edn., 1893, Figure 796
 5. **Chain Drives:** *Codex Madrid I*, Folio 10r
Reuleaux's *The Constructor*, 4th Edn., 1893
 6. **Pin Bearings:** *Codex Madrid I*, Folio 118r
Reuleaux's *The Constructor*, 4th Edn., 1893
 7. **Thrust Ball Bearing:** *Codex Madrid I*, Folio 101v
Reuleaux's *The Constructor*, 4th Edn., 1893
 8. **Ball Bearing:** *Codex Madrid I*, Folio 20v
Reuleaux's *The Constructor*, 4th Edn., 1893, Figure 567
 9. **Bearing Supports:** *Codex Madrid I*, Folio 101r
Reuleaux's *The Constructor*, 4th Edn., 1893, Figure 309
 10. **Wedge Key:** *Codex Madrid I*, Folio 46v, 47r
Reuleaux's *The Constructor*, 4th Edn., 1893, Figure 179, 180
 11. **Elastic Springs:** *Codex Madrid I*, Folio 85r
Reuleaux's *The Constructor* 4th Edn., 1893, Figure 19
 12. **Brake Mechanism:** *Codex Madrid I*, Folio 10r
Reuleaux's *Kinematics of Machinery* (1876), Figure 336
 13. **Couplings:** *Codex Madrid I*, Folio 62r
Reuleaux's *The Constructor*, 4th Edn.
 14. **Piping:** *Codex Madrid I*, Folio 25v
Reuleaux's *The Constructor*, 4th Edn., 1893
-

Cornell University has the largest collection of digitized books related to the history of machines and mechanisms. A list of these books may be found in Part IV in the Appendices. These books can be accessed directly through the website <http://kinematic.library.cornell.edu>. To access the manuscript pages of Leonardo da Vinci in the *Codex Madrid*, through the KMODDL webpage, click on the 'References' to obtain a list of digitized books related to the history of machines and mechanisms. Click on *Codex Madrid* to access the manuscript folios of Leonardo. In addition to Leonardo's work, one can access many of the 'Theatre of Machines' books such as Ramelli and Leupold and others listed in Table II.4.

1. The Four Bar Linkage

Four links connected in a closed chain with pin or revolute joints form the basis of four, four-bar mechanisms each of which is obtained by grounding a different link. In the classic case, the geometry of the connecting link is chosen such that a circular motion of the driver link or crank results in the oscillating motion of the opposite link. This is called a crank-rocker mechanism in some books. On the other hand, if two opposite links are shorter than the other pair, grounding one of the shorter links can result in both driving and follower links moving in a circle. This is known as a lag or drag-link mechanism. The four-bar linkage can also be used as a parallel mechanism as well as an approximate straight-line mechanism.

Leonardo da Vinci, *Codex Madrid I*, Folio 1r

In this drawing, Leonardo appears to have recognized the problem of lock-up in the rotation of the four-bar linkage. In the central figure, he shows how to restrict the motion of the connecting rod (sensale) from moving from one side to another. In the text next to this drawing, Leonardo discussed the kinematics of the linkage (translation by Ladislao Reti):

Consider the position of these two cranks and observe the motion made by the lower crank in its movement to the left. You can see that it is moving down; the upper crank would be raised, but the length of the sensale does not permit it, and as a consequence the crank returns. Should you wish to turn the other in a complete revolution by turning one of the cranks with the aid of such an instrument, you would be deceiving yourself.

Reuleaux–Voigt Model (C-1)

Reuleaux designed his models to allow the instructor to ground any of the four links in this four-bar chain. Not shown here is another pedestal and clamp that allows each of the four links to be grounded, thereby demonstrating that one can obtain four different transformations of motion from one closed kinematic chain. These four related mechanisms are called *kinematic inversions* of the basic closed chain. Reuleaux also showed how such mechanisms could lock up as did Leonardo; a small change in the motion of one link can result in indeterminate motion of the other links. This problem was known to machine designers in the 19th century and several techniques were employed to avoid it. The problem of kinematic lock-up or singularity is also a design problem in modern serial link robotic manipulator arms. This model can be printed out via rapid prototyping using a stereolithography file from the Cornell KMODDL website.

1. The Four Bar Linkage



Figure III.1a. Four-bar linkage: *Codex Madrid I*, Folio 1r

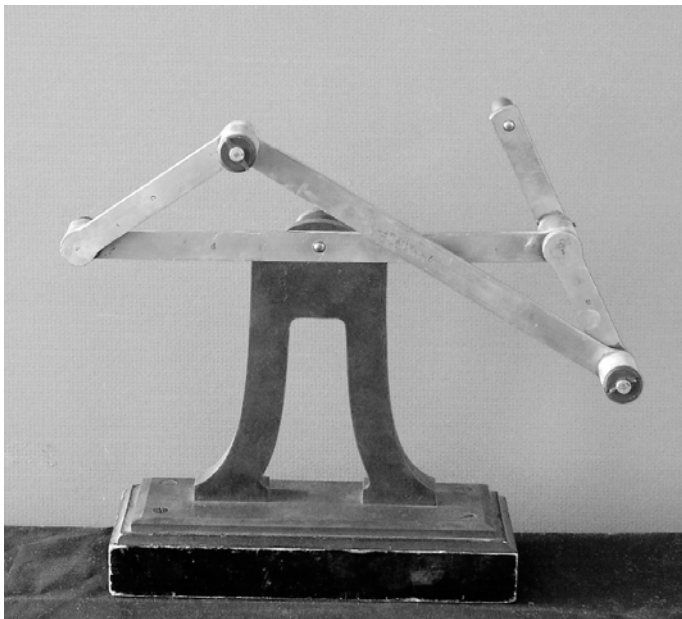

Figure III.1b. Four-bar linkage: Reuleaux–Voigt Catalog, Model C-1 (Cornell Collection of Kinematic Mechanisms)

2. The Slider Crank Mechanism

The slider crank mechanism is one of the most ubiquitous mechanisms in modern machines as it appears in all of the internal combustion piston engines of the world. The basic elements consist of three links connected with pin or revolute joints plus one link that slides relative to one of its neighboring links. In the case of the piston engine, the engine cylinder, connecting rod and crank are three of the links, while the piston slides relative to the cylinder. The sliding piston has roots going back to the ancient Greeks and Romans in the action of water pumps. A version of the slider crank appears in the machine picture books of the Renaissance such as the book of Besson (1578) and in the work of Francesco di Giorgio Martini (c. 1450). Leonardo had a copy of one of Di Giorgio's books in his library and was likely familiar with the machines that were described therein.

Leonardo da Vinci, *Codex Madrid I*, Folio 28v (see also Folio 30r or 2r)

Leonardo used the slider crank to convert circular motion into alternating motion in machines as illustrated in the drawing to the right. His comments next to this drawing are: *"This movement is most praiseworthy, both for the ease of motion and the compactness of design"*. In Leonardo's drawing on the top of Folio 30r shows a compound linkage with a worm drive in the rear and a slider-crank in the middle. In this case the slider pair of joints rotate, showing a variation of the slider crank.

His notes make no mention of the possible use of the machines using this mechanism. In Besson (1578) the mechanism is used in a machine to saw logs into boards, converting the hand crank motions of a worker into the up and down motion of the saw blade.

Reuleaux–Voigt Model (C-2)

Reuleaux used the slider crank mechanism to demonstrate his theory that mechanisms are closed chains of links. In this example, there are four links connected by three revolute joints and one sliding or prismatic joint. The grounding of any one link, and the prescribed motion of any other link, determines the motion of the remaining two links independent of the forces and torques on the links. Thus for Reuleaux, the nature of the motion in machines is reduced to geometry. He designed his models such that any of the four links could be fixed or grounded. In the model shown on the right, for example, the 'piston' link is fixed and the crank oscillates as well as rotates. Besides engines, the slider crank mechanism is used in machine tools for work-piece motion and quick-return mechanisms. Two slider-crank mechanisms driven by the same crank wheel are used in Stirling engines. This model can be printed in plastic via rapid prototyping using the stereolithography file in the Cornell website KMODDL.

2. The Slider Crank Mechanism

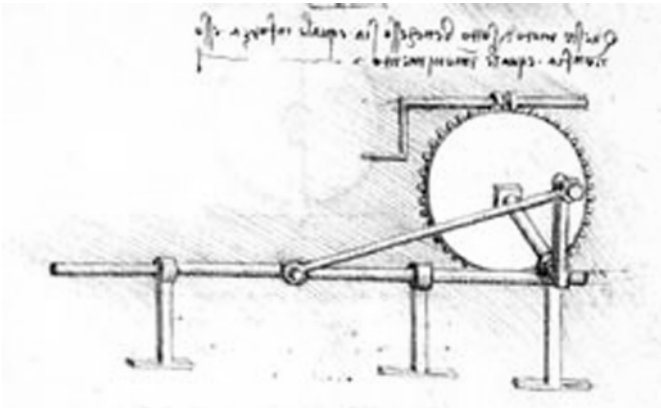

Figure III.2a. Slider crank mechanism and worm drive: *Codex Madrid I*, Folio 28v (see also Folio 30r or 2r)

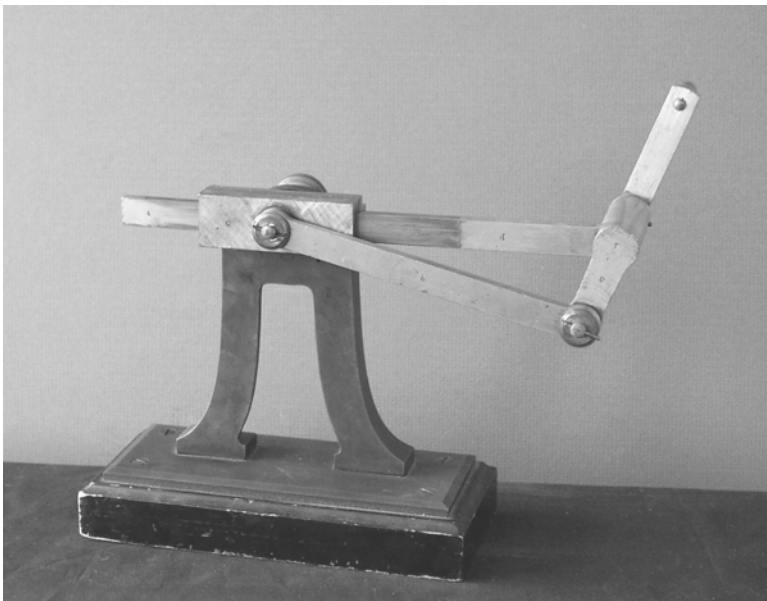

Figure III.2b. Slider-crank mechanism: Reuleaux-Voigt Model, C-2 (Cornell Collection of Kinematic Mechanisms)

3. Lazy Tongs or Nürnberg Shears Linkage

The lazy tongs is a compound linkage of crossed links in which a small change in the lateral distance between links will result in a large extension of the mechanism proportional to the number of cells created by the crossed links. One application is for a gripper to reach objects on high shelves, hence to name 'lazy tongs'. The device has also been called Nürnberg shears or scissors. Another name is a pantograph used in drawing aids.

Leonardo da Vinci, *Codex Madrid I*, Folio 24v (also Folio 157v)

The drawing in Folio 24v seems to show that successive links become shorter. Whether this was meant to convey actual lengths or it was simply artistic foreshortening we cannot tell. Leonardo's only notes on this page asks the rhetorical question: How can one determine the force on the crank of the turning screw if one knows the weight on the end of the lazy tongs? But Leonardo does not provide an answer. Leonardo also shows a design for Nürnberg shears in *Codex Atlanticus* (CA 16 r.; see also Figure I.34). Examples of this mechanism however can be found in books of several other machine designers in the Renaissance such as Kyeser, Francesco di Giorgio, Besson and Ramelli. One of the applications was for scaling ladders for sieges. In Ramelli (1588, Plate 146) there is a design for a collapsible pontoon bridge to cross a river. His mechanism is driven by two screws of opposite helixes, as in Leonardo's Folio 24. However, it is unlikely that Ramelli had seen Leonardo's drawings since they were in the hands of his student Melzi and because this mechanism, as so many at the time, was likely part of the kinematics 'language' of machine builders of the times.

Reuleaux–Voigt Model (T-2)

In Reuleaux's classification scheme in the Voigt catalog of his models, he enumerates straight-line mechanisms (Series 'S') and parallel mechanisms (Series 'T'). The lazy tongs has the property that as it is extended, a line joining the opposite revolute joints remains parallel to itself. This is illustrated in Model T-2. A modern use of this mechanism (referred to as a pantograph) is for electric power pickup on high-speed trains. When combined with a spring, the end of the pantograph will extend up to a power line above the moving train and maintain contact with the power cable. Following Grübler's criterion (see Section I.8), one can show that no matter how many links and joints one adds to the lazy tongs in *Codex Madrid I* (Folio 24 v), it will always have one degree of freedom, i.e. turning the screw crank at the bottom moves the entire linkage effortlessly.

This mechanism is described in Brown's 1871 manual of 507 mechanisms (#144) available online through KMODDL. A movie of the lazy tongs can be seen on the KMODDL website under Clark Models; Boston Museum of Science, Model number 112. A printable plastic model can be made via rapid prototyping using the stereolithography file in KMODDL.

3. Lazy Tongs or Nürnberg Shears Linkage

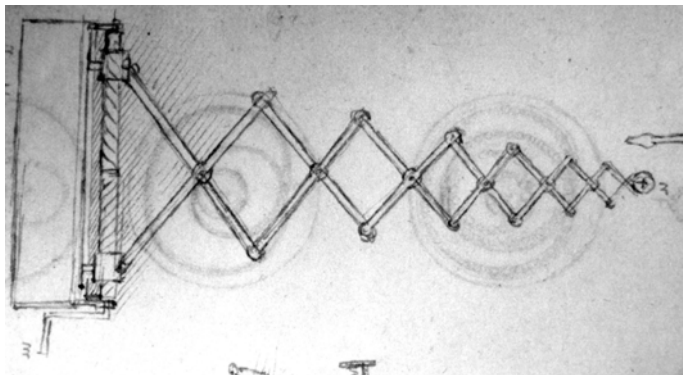

Figure III.3a. Lazy tongs or Nürnberg shears: *Codex Madrid I*, Folio 24v

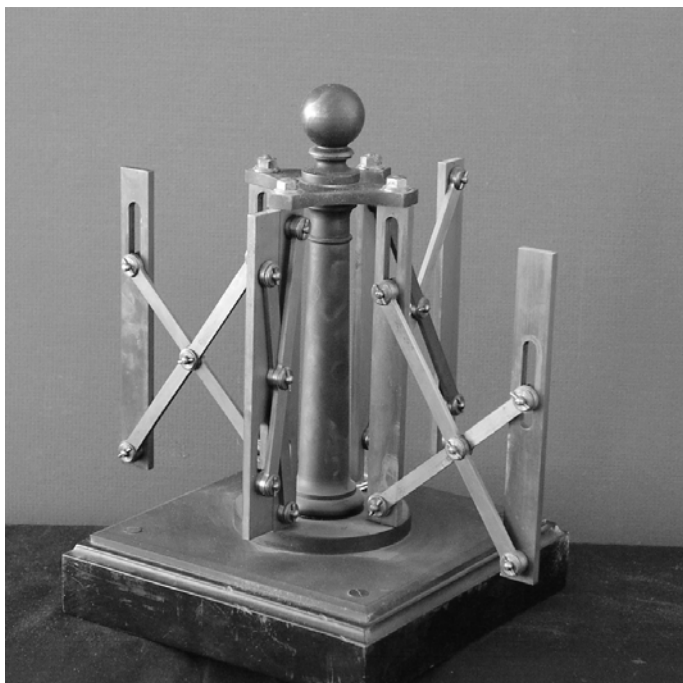

Figure III.3b. Lazy tongs – parallel mechanism: Reuleaux–Voigt Catalog, Model T-2 (Cornell Collection of Kinematic Mechanisms)

4. Universal Joint and Gimbals

The universal joint and gimbals linkage are essentially the same linkage but used for different applications. They both allow rotation about two crossed axes. The gimbals linkage is likely the older of the two having roots in China and Tibet. Today gimbals can be found in mechanical gyroscope design as well as for joints in robot arms (see e.g. Rosheim, 1994). The universal joint is used to transmit rotary motion between two axes that intersect but are not parallel. A common application is in automotive drive shafts between the engine and rear axels. In 1903 Clarence Spicer, a Cornell student at the time, received an American patent for a universal joint in an automobile. In the British literature the 'U' joint is called a Hooke's joint and appeared in an astronomical instrument design circa 1676. Other authors call the gimbals mechanism a Cardan joint after Girolamo Cardano [1501–1576].

Leonardo da Vinci, *Codex Madrid I*, Folio 13v

The drawing of the gimbals does not give us a clue as to Leonardo's motivation except that he refers to a device to hold a mariners compass on ships. The gimbals, if there is low friction, will maintain the compass or a candle holder in a horizontal level as the ship pitches and rolls. There is much evidence that the invention appeared in China and/or Tibet as artifacts have been found with gimbals dating to around 500 CE (see Needham, 1965, Figures 477, 479, 480, 481). The so-called Cardan suspension also appeared in the *Sketchbook* of Villard de Honnecourt (1237). This mechanism was likely part of a universal kinematic language in several parts of the world and may not have a unique inventor. Tibetan lamp holders may have found their way to Venice or Rome where engineers such as Leonardo may have seen one.

Reuleaux–Voigt Model (P-1)

Reuleaux created two models of the universal or Hooke's joint that he attributed to Cardano. The standard 'U' joint has the property that the output rotation rate is unsteady when the rotation rate of the input shaft is steady. However, placing two universal joints in series can result in steady rotation rates on both input and output shafts. Model P-2 is a double 'U' joint and is a beautifully designed pedagogical model that demonstrates this principle. Today there are other equivalents of the double universal or constant velocity joint used in automotive applications in the mechanisms of Bendix-Weiss, Rzeppa, and Tracta.

Reuleaux was the first to show that the universal joint and the gimbals linkage are essentially four-bar linkages on a sphere. Several variations of spherical four-bar linkages have been used as pumps or steam engines in the early 19th century. Reuleaux created a model of one such pump-engine mechanism in his Model F-6. (See this model on the KMODDL website.) The universal joint is also described in Brown's 1871 manual of 507 mechanisms (#50, #51) and can be read online through KMODDL. A movie of this model can also be seen in the Clark models of the Boston Museum of Science (model 17) also available on KMODDL.

4. Universal Joint and Gimbals

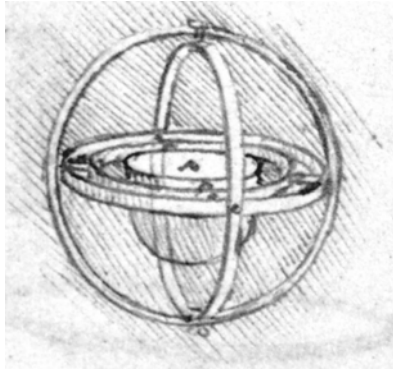

Figure III.4a. Gimbals mechanism: *Codex Madrid I*, Folio 13v

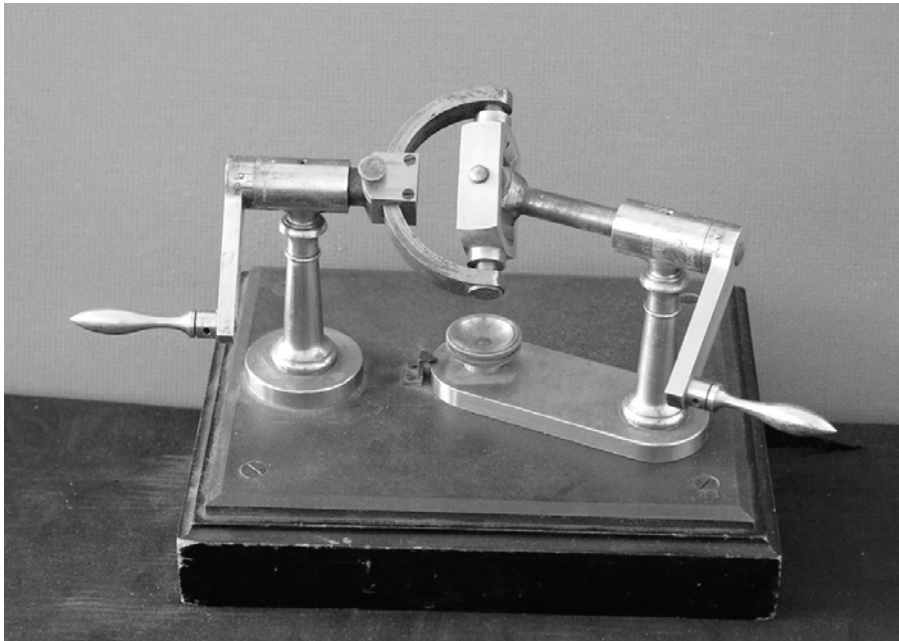

Figure III.4b. Universal joint: Reuleaux–Voigt Catalog, Model P-1 (Cornell Collection of Kinematic Mechanisms)

5. Belt Drive Mechanism

A belt drive consists of a continuous flat material, such as leather, wrapped around cylindrical pulleys designed to transmit power from one axle to another. Before the age of small electric motors, this was a common method of distributing power in shops and factories. The flat belt had an advantage over rope drives in that it could be easily adapted to speed changing devices by moving the belt from one pulley to another with a belt shifter. Karl Benz used a belt-drive transmission in his first gasoline powered automobile in 1885. Rope or cable drive mechanisms are more common today in ski lift and cable car systems in mountainous areas as well as in cable lift cranes in construction machines.

Leonardo da Vinci, *Codex Madrid I*, Folio 23r (also Folios, 30v, 65v, 68v, 119r)

Leonardo used belt and rope drives for two different purposes: as a kinematic mechanism to transmit motion, and in pulley systems to produce high load lift with human force. Drawings of kinematic applications are shown in Folios 23r and 119v. In the figures from Folio 23, there is a mass attached to the belt between the pulleys that create a mechanism to change rotary motion into linear motion. Such a mechanism is used in modern ink jet printers to move the ink cartridge across the page. His notes on Folio 23, translated by L. Reti (1974), read: “*Every motion made by ropes is gentler and less noisy than if made by the aid of toothed wheels and pinions*”. “*Every motion made with pinions and teeth will make a great noise*”.

The recognition of the problem of noise in machines with gear teeth and its amelioration by the use of rope drives shows that Leonardo was familiar with the practice of machine making. Several machine designs of Leonardo such as in Folios 30v, 65v, 68v, use a cable drive for textile thread spinning machines.

Reuleaux–Voigt Model (V-1)

Reuleaux called belt and rope drive mechanisms ‘*tension organs*’ since they required the belt or rope to be in tension and hence produce a friction induced torque on the wheel or cylinder. He designed more than 20 belt drive mechanisms for the Voigt catalog of kinematic models. In several models the cylindrical pulleys have diameters larger in the center than on the edges. In one model of Reuleaux, (V-2), one can demonstrate that a belt will move towards the center of the cylinder under motion. Counter to one’s intuition, a ‘crowned’ cylinder has no need of an edge lip to keep the belt on the pulley. There is no evidence that Leonardo knew of this design principle. Today belt drives are common in automotive applications to drive auxiliary units off the motor such as pumps, alternator and fan belt.

5. Belt Drive Mechanism

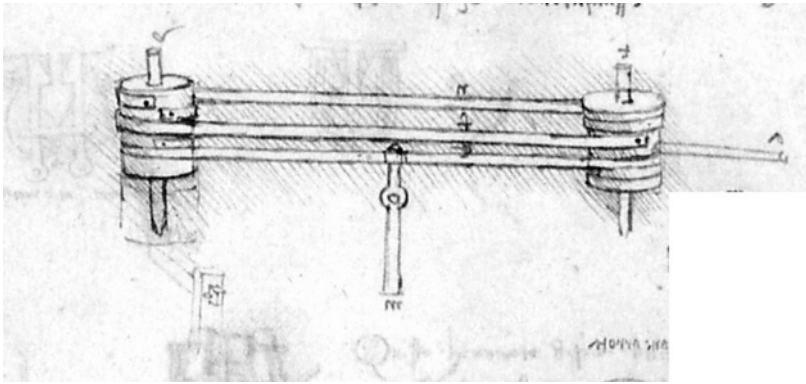

Figure III.5a. Belt and pulley mechanism: *Codex Madrid I*, Folio 23r

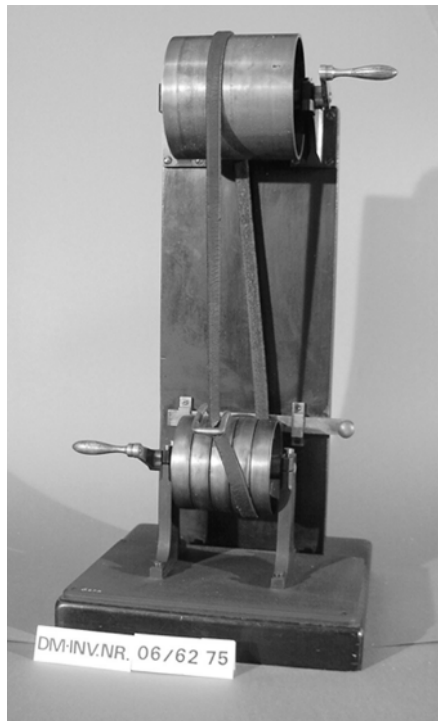

Figure III.5b. Belt and pulley mechanism: Reuleaux Deutsches Museum Model, DM 06/6275 (c. 1880)

6. The Endless Screw

The endless screw mechanism, called a worm drive in modern parlance, is used to transmit rotary motion about an axis tangential to the circumference of a large circular gear that rotates about an axis perpendicular to the worm. Since the diameter of the screw or worm gear is often much smaller than the circular gear, the angular velocity of the worm is much faster than that of the larger gear. Hence this mechanism can transmit high torque on the large gear with much smaller torques on the worm. The friction force between the teeth of the screw pair usually permits the worm as the driver but not the reverse. Thus this mechanism is much preferred for winches. This mechanism is attributed to Archimedes [c. 250 BCE] and is mentioned in the writings of Hero. The endless screw can be found in published works on machines in the work of Francesco di Giorgio and Leonardo da Vinci as well as later machine books such as Besson (1678).

Leonardo da Vinci, *Codex Madrid I*, Folio 17v

Leonardo used the endless screw in many of his machines. In this figure he drew the isolated kinematic pair. The worm drawn here is unusual in that the worm wraps around the large wheel by increasing the radius from the center of the worm. Most modern worm screws have a constant radius. Leonardo reasoned that this design would engage more teeth.

The lifting device has an endless screw which engages many teeth in the wheel. For this reason the device is very reliable. Endless screws that engage only one of the teeth on the working wheel could cause great damage and destruction if the tooth breaks.

This quote from the translation of L. Reti (1974) suggests that Leonardo had knowledge of trade practice as well as case studies of past failures.

Reuleaux–Voigt Model (C-9)

This model shows the standard worm drive with constant radius worm. However Reuleaux discussed the ‘wrap around’ worm gear in his machine design book, *The Constructor* (1893). He called such forms ‘globoid’ gears, in this case an internal globoid gear (see Figure 641, p. 143), or a ‘globoid worm’. Reuleaux commented that:

the teeth can be made of straight profile in the worm wheel as well as in the worm.
— The advantage appears to be in the simple form of the tooth and in the completeness of the engagement.

This Reuleaux model can be printed in plastic via rapid prototyping using a stereolithography file available in KMODDL. Reuleaux also used the endless screw in the Voigt models Y-9, Y19.

6. The Endless Screw

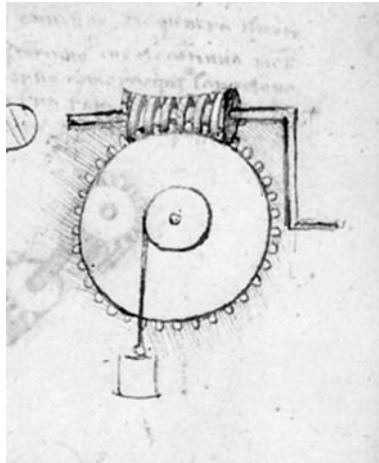

Figure III.6a. Endless screw or worm drive: *Codex Madrid I*, Folio 17v

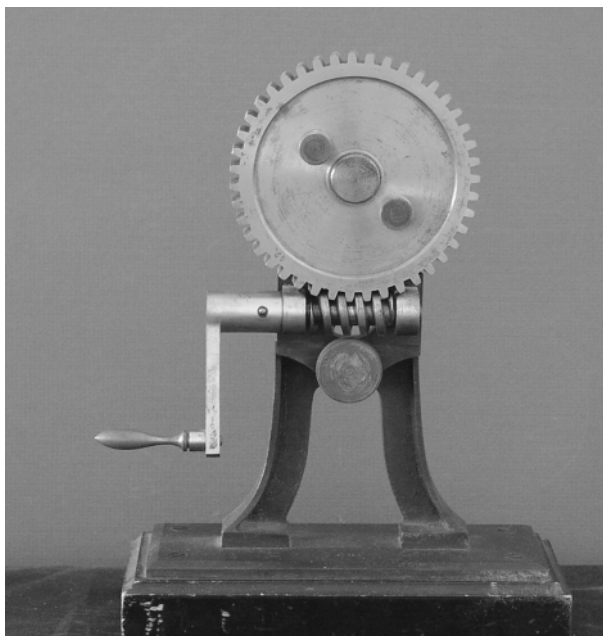

Figure III.6b. Endless screw or worm drive: Reuleaux–Voigt Catalog, Model C-9 (Cornell Collection of Kinematic Mechanisms)

7. Screw Mechanisms

The screw is one of the simple machines of ancient Greek engineering. According to Drachmann (1963) it appeared slightly before Archimedes and after Aristotle. The screw was used in Archimedes' pump as well in the worm drive or endless screw. A screw kinematic pair usually consists of a helical groove cut in a cylinder called the 'screw', and a mating or female part called a 'nut' that consists of a solid with an internal helical groove to match the screw. Screw and nut pairs come in right and left-handedness. Many applications for this pair are for clamping two solids together. However there are many uses of the screw pair in kinematic mechanisms. As the nut turns relative to the screw, it also advances linearly along the screw axis. As a simple machine, the screw also enjoys a mechanical advantage in being able to push or pull a large load with a small torque applied to either the nut or the screw.

Leonardo da Vinci, *Codex Madrid I*, Folio 26r

Leonardo's design for a screw jack was apparently intended to lift large loads from the screw cylinder below the nut platform. A similar design can be found in the machine books of Francesco di Giorgio. However what makes Leonardo's design unique is the use of ball bearings to lessen the friction between the nut platform and the nut. Leonardo realized, that without such bearings, the friction between the nut and the platform would cancel out the theoretical advantage of the screw-nut pair. Today one can find a different variation of this design called a *ball-screw mechanism* in which ball bearings roll between the screw and the nut. These are sometimes used in robotics as well as in aircraft controls.

Reuleaux–Voigt Model (A-1)

Reuleaux defined the constrained nut and screw as a kinematic 'lower pair' joint because it involved surface contact between the two solids. The screw pair is shown in model A-1. However Reuleaux also showed how the screw pair could become part of a kinematic chain or circuit. Voigt models M1-M3 were designed to demonstrate pure kinematic mechanisms with screw-pairs or constraints. (See the website KMODDL to view M-1 to M-3 kinematic models.) In §151 of his *Kinematics of Machinery* (1876) Reuleaux discussed several variants of the screw-pair kinematic chain including a circuit with three co-axial screws, a circuit with two co-axial screws and a prismatic or sliding joint and a circuit with two co-axial screws and a cylindrical joint, that can slide and turn. The circuit with two co-axial screw-pairs has been used in a differential screw-measuring device of importance to precision machining.. An example of a differential screw may be seen in Reuleaux–Voigt Model M-7.

7. Screw Mechanisms

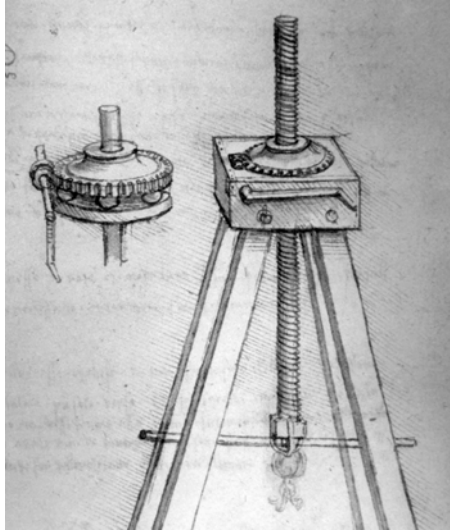

Figure III.7a. Screw jack: *Codex Madrid I*, Folio 26r



Figure III.7b. Screw pair: Reuleaux–Voigt Catalog, Model A-1 (Cornell Collection of Kinematic Mechanisms)

8. Double Helix Reversing Mechanism

Many machine operations in manufacturing require a reversing motion pattern when the input motion is steady rotation. A popular reversing mechanism in the Renaissance was a half toothed crown wheel gear and lantern pinion as described below in this catalog. A more sophisticated reversing mechanism is the use of two crossed helices or double helix. In this device a slider part is made to move in a groove as the helix cylinder rotates. The key to the successful working of such a design is the switching mechanism on the slider link when it reaches the end of the helix switching from say the right-hand helix to the left-hand helix.

Leonardo da Vinci, *Codex Madrid I*, Folio 15r (also Folio 18r)

Leonardo's drawing of this mechanism clearly shows the two helices on separate cylinders and the traveling slider. In the script next to the drawing he writes:

Once it has arrived at the summit of the leading screw, it is abandoned and then enters the beginning of the other screw. As it arrives at the foot, lever **m** touches bottom, is disengaged and enters the other screw as it did before.

He also has a design with two double helices on one cylinder on Folio 18r. On Folio 15r there is a design on the right for a switching mechanism on the slider. It is not clear what application Leonardo had in mind though on Folio 18r he mentions a clock application. This mechanism does not appear in the work of other contemporaries such as Francesco di Giorgio Martini and it is likely this was an invention of Leonardo. Perhaps he was inspired by the Archimedes helical pump that moves a fluid in a linear path using a rotary motion of a cylinder.

Reuleaux–Voigt Model (M-6)

Reuleaux called the helical reversing mechanism a 'mangle' probably referring to such devices in washing machines. In Reuleaux's model M-6 the linear slider moves in a track as the cylinder turns. The slider is switched from the right to the left hand helix by a tripping mechanism at the ends. There is no description of this mechanism in either of Reuleaux's major books of 1876 or 1893. In Model M-4 (see KMODDL website), Reuleaux has a single screw actuated reversing mechanism with a linear slider. However the switching mechanism seems to be more complicated than the double-screw or double-helix device in M-6.

8. Double Helix Reversing Mechanism

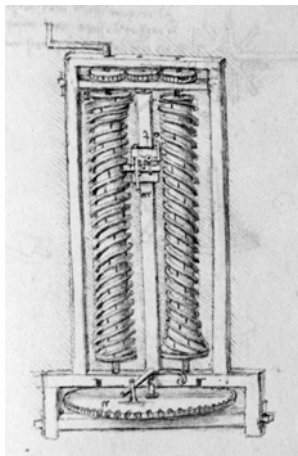

Figure III.8a. Double helix reversing mechanism: *Codex Madrid I*, Folio 15r

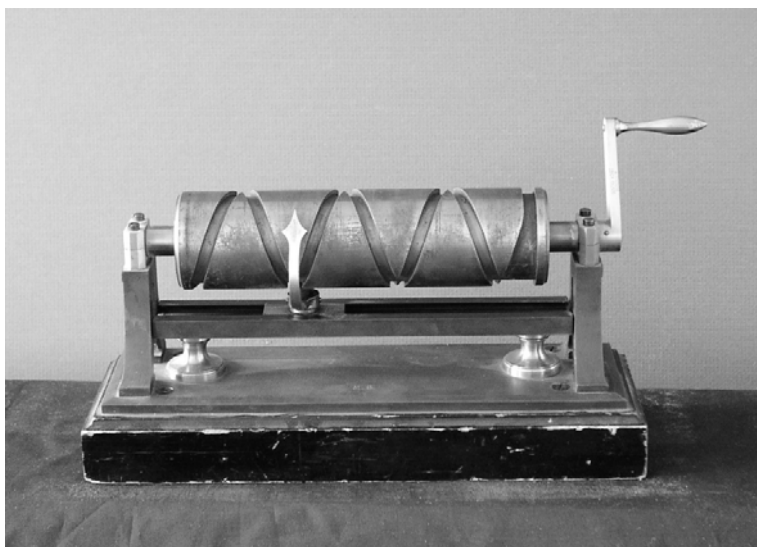

Figure III.8b. Double helix reversing mechanism: Reuleaux–Voigt Catalog, Model M-6 (Cornell Collection of Kinematic Mechanisms)

9. Reversing or Mangle Mechanism

The original mangle (switching or reversing) mechanism used toothed wheels to convert continuous rotary motion into alternating linear or rotary motion. The device can be found in several machine books from the 15th to the 17th century. Reversing mechanisms were used in washing machines in the late 19th and early 20th century as well as in manufacturing machines.

Leonardo da Vinci, *Codex Madrid I*, Folio 17r (see also Folios 30v, 31r)

Leonardo's reversing or mangle mechanisms took several different forms. In the design shown in Folio 17r he used two half toothed pinions and a crown wheel gear with a complete circle of pin teeth. In Folio 30v he used two lantern pinions on a shaft engaged with a crown wheel gear with a half circle of pin teeth. In the first design each pinion has only half a circle of teeth. As the pinion axle rotates, the top pinion forces the toothed wheel first in one direction and the bottom pinion forces the wheel in the opposite direction. The reversing motion is the same for both designs. The text in Folio 17r, reads (Reti, 1974):

Here a constant circular motion generates a constantly discontinuous motion, that is, a motion that continuously goes back and forth such as the motion imparted by the pinion to its wheel. And this is the seventh type among composite motions.

This last line of Leonardo's seems to indicate that he had in mind a scheme for classification of mechanisms according to the type of motion transformation produced by the device. This program for kinematics of machines was formalized by faculty at the Ecole Polytechnique in Paris in the late 18th century.

Reuleaux–Voigt Model (Deutsches Museum) (see also Voigt model M-6)

The reversing mechanism shown in the right figure did not appear in the first Voigt series of Reuleaux models but appears in the second series. This model, apparently from Reuleaux's original Berlin collection is among 60 in the Deutsches museum in Munich. This is a different design than Leonardo. There is almost a full set of pin teeth in the big wheel. However the pinion axis is designed such that it can engage the wheel pins either on the outside or the inside. Each transition causes the direction of rotation of the wheel to reverse. In another reversing mechanism captured in Voigt model M-6, called the 'Double screw of Napier', a pin is made to follow a helical path in the right-hand direction and then switches to follow a left-hand helical screw path. In this mechanism, the reversing direction is along a straight line.

Mangle wheel mechanisms can also be found in the manual of 507 mechanisms of Brown (1868) (mechanisms #192, #193, #194) available online at the KMODDL website.

9. Reversing or Mangle Mechanism

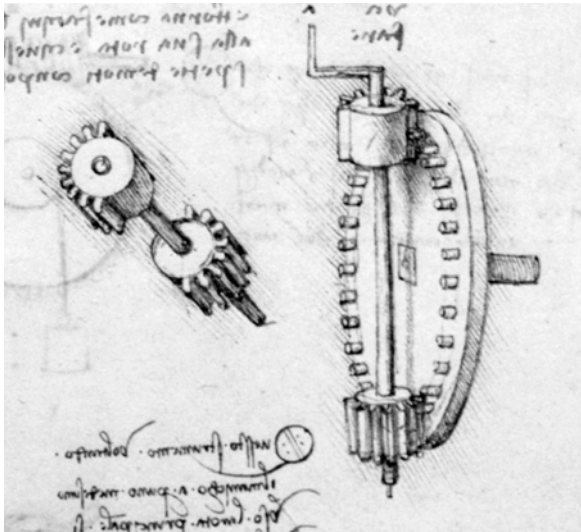

Figure III.9a. Pin-teeth rotary reversing mechanism: *Codex Madrid I*, Folio 17r

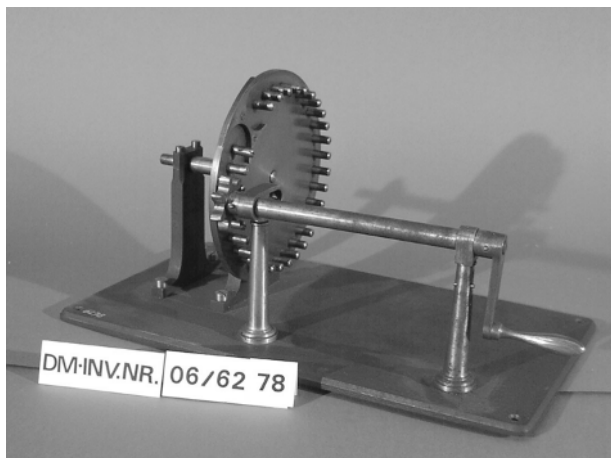

Figure III.9b. Pin-teeth reversing mechanism: Reuleaux Model; Deutsches Museum DM 06/62/78 (c. 1880)

10. Intermittent Mechanisms – Geneva Wheel

Machines often have a steady source of rotary motion (e.g. an electric motor) but require an output motion that is intermittent in time, sometimes with a dwell or dead time when there is no motion. Many devices have been invented with finite dwell time properties. Some of these mechanisms fall into a class of cam mechanisms or pin-lever tripping mechanisms. Others such as the Geneva mechanisms use a pin in a prismatic joint whose advantage is that it avoids impact forces typical of pin-lever mechanisms. A modern catalog of intermittent mechanisms is by Bickford (1972). (See KMODDL for an online copy.)

Leonardo da Vinci, *Codex Madrid I*, Folio 7r

The intermittent mechanism shown on Folio 7r of the *Codex Madrid I* is one of several designed by Leonardo for manufacturing and textile machines. In the design at the top of Folio 7r, one pin trips the top lever in one direction and another face pin trips the lower lever in the other direction after a short dwell period. The levers are attached to a double slider mechanism that alternatively moves the horizontal slider back and forth. In a similar design below the wheel has radial pins instead of face pins to trip the lever. There is nothing in Leonardo's notes to suggest what if any application he had in mind. As has been suggested by many scholars, it appears that in many of the folios of the *Codex Madrid*, Leonardo began to catalog a basic set of kinematic and machine elements or 'elementi macchinali' that could be used in the design of machines.

Reuleaux–Voigt Model (M-8)

Reuleaux designed a number of intermittent mechanisms for his model collection in the Voigt Catalog N-8 through N-17. A few are similar to the Leonardo pin-tripping mechanism discussed above. Applications of intermittent mechanisms in the 19th century included valve regulators of steam engines, textile machines and clock and watch mechanisms. The Geneva mechanism got its name from its use in a watch design in Geneva during the 18th century to limit over winding the spring. Later it was used in early motion picture projectors and cameras to produce a dwell period for each frame of the movie film. The Geneva mechanism is sometimes called a *Maltese Cross*. Reuleaux has a discussion of these so-called 'continuous ratchets with locking teeth' in *The Constructor* (1893), in Section 255 (Figures 756 to 760).

The Geneva mechanism is also in the manual of 507 mechanisms of Brown (1868) (mechanism #212). A model based on the Brown manual may be found in the Clark model collection of the Boston Museum of Science, Model #52, which can be seen on the KMODDL website.

10. Intermittent Mechanisms – Geneva Wheel

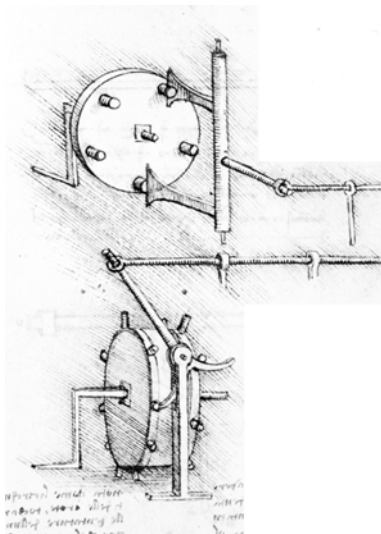

Figure III.10a. Two intermittent mechanisms: *Codex Madrid I*, Folio 7r

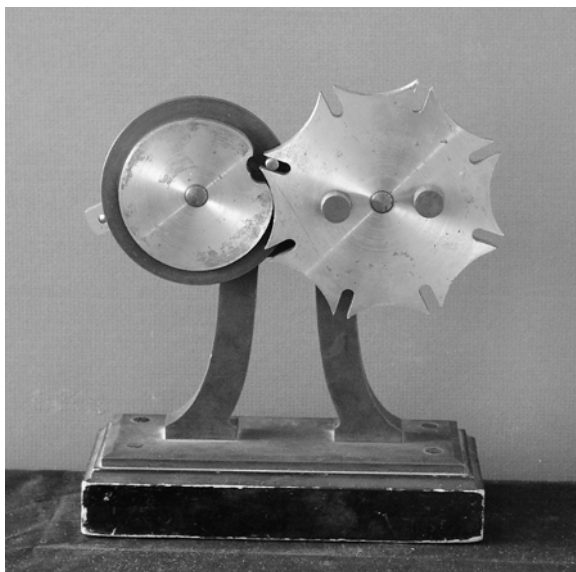

Figure III.10b. Intermittent mechanism – Geneva Wheel: Reuleaux–Voigt Catalog, Model N-8 (Cornell Collection of Kinematic Mechanisms)

11. The Ratchet and Pawl

The ratchet and pawl mechanism allows motion in one direction but locks it in the other direction. In this sense it acts in the same way as a diode in an electrical circuit or a check valve in a water pipe. The ratchet and pawl was often used with a winch or windlass, a horizontal drum with a rope or cable attached, which allowed the rope to be wound onto the cylinder but prevented the cylinder from unwinding the rope. Ratchet mechanisms can also be used to convert alternating motion into unidirectional rotary motion.

Leonardo da Vinci, *Codex Madrid I*, Folio 117r (also Folio 123v)

This drawing shows a ratchet with a rope attached to a weight creating an unwinding moment. The horizontal lever or pawl, acting under gravity, prevents the rope from unwinding. Leonardo does not show a winding crank nor the axle, bearings and supports that would complete this mechanism. The drawing captures however the essence of the ratchet and pawl. In a translation of the description (Reti, 1974), Leonardo wrote:

Among engineers, there is an instrument in use called *ritentaculo* (a ratchet and pawl), by Florentines, —. Its only purpose is to prevent the slipping or turning back of something in motion. This adds great security to weight lifting motors.

Reuleaux–Voigt Model (N-1)

Reuleaux was fascinated with ratchet mechanisms and designed several different models to illustrate the different motions and uses of the ratchet. In his machine design book *The Constructor* (1893, p. 150), he defined the ratchet in the similar way as Leonardo da Vinci:

The object of the ratchet is to check the action of certain portions of a machine and so modify an otherwise continuous motion into some intermittent form.

The use of control valves in steam engines and internal combustion engines in the 19th century to regulate speed represented the beginnings of automatic control of machines. Reuleaux saw the special digital nature of ratchet mechanisms, on or off, as having special significance in machine regulation and created several models to express the role of ratchets in machine control devices. Reuleaux recognized the importance of control in machines but did not have the mathematical concepts to describe it.

There are many ratchet mechanisms described in Brown's 1868 *Five Hundred and Seven Mechanical Movements* (#75, 76, 79, 80, 82). Clark's model of a working ratchet, based on Brown's manual, now at the Boston Museum of Science, can be seen on the KMODDL website (Model 57).

11. The Ratchet and Pawl

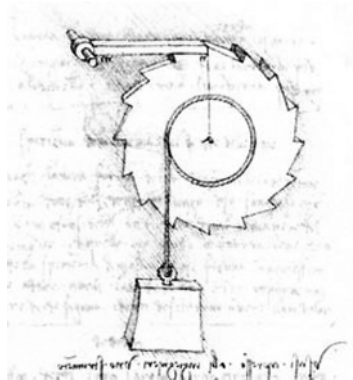

Figure III.11a. Ratchet and pawl mechanism: *Codex Madrid I*, Folio 117r

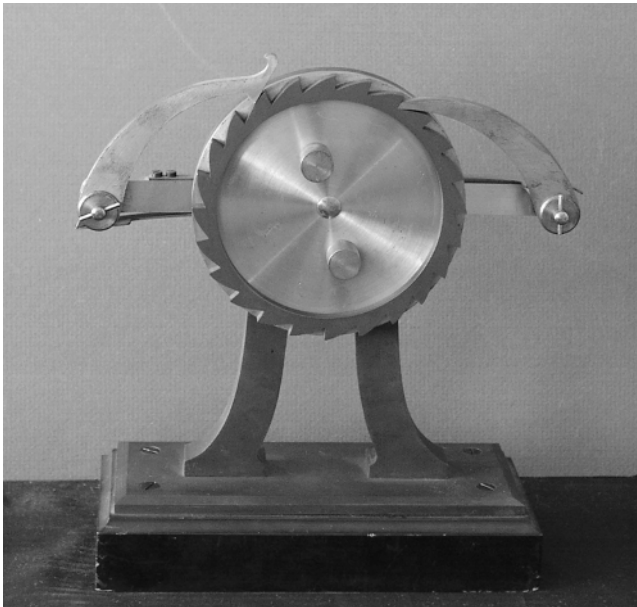

Figure III.11b. Ratchet and Pawl Mechanism: Reuleaux–Voigt Catalog, Model N-17 (Cornell Collection of Kinematic Mechanisms)

12. The Verge or Crown Wheel Escapement

The verge escapement is a wheel with saw-like teeth engaged with two pallets on an axel (called the verge) parallel to the wheels diameter. This device is used to control the motion of a falling weight as in a clock or a pump. In the 14th century, it was coupled to a rotating bar or *foliot*, and used in tower clocks before the invention of the pendulum clock of Huygens. The verge and foliot was also described in the machine picture book of Strada (1623) that shows its use in water pumps. The foliot oscillates and the pallets engage the saw-toothed wheel each half cycle, thereby controlling the movement of the pump. The anchor escapement replaced the verge escapement in clocks in the 17th and 18th centuries. Escapements are not true kinematic devices since the period of oscillation depends on Newton's laws of dynamics and friction as well as the geometric constraints.

Leonardo da Vinci, *Codex Madrid I*, Folio 115v (see also Folios 9r, 61v)

One of the surprises in reading the Code Madrid is the awareness of Leonardo's interest in mechanisms for clock design, including the escapement shown in the figure. In this drawing, the 'scape' *wheel* is in the vertical plane. He uses the Italian words "*tempo dell'orologio*". In Folio 115v he wrote:

It is custom to oppose the violent motions of the wheels of the clock by their counterweights with certain devices called escapements, ('*tempo*'), as they keep the timing of the wheels which move it. They regulate the motion according to the required slowness and the length of the hours. The purpose of the device is to lengthen the time, a most useful thing.

This may be one of the earliest and clearest descriptions of the verge and foliot, even though it was in use in clocks perhaps a century or more before Leonardo. Below the figure on Folio 115v, Leonardo provided details about the design of the pallets and their engagement with the teeth of the crown wheel.

Reuleaux–Voigt Model (X-1)

The verge and foliot escapement without a pendulum or balance wheel oscillator was a very poor timekeeper. In 1657, Christian Huygens built a clock with a pendulum and verge escapement that led to more accurate timekeepers. Later the pendulum was replaced with a balance wheel and torsional spring and achieved the same result. The crown wheel escapement with balance wheel is realized in the brass and iron model of Reuleaux in the figure to the right. Reuleaux designed ten clock escapements in his model collection, including the anchor, gravity and chronometer escapements. Reuleaux discussed escapements in *The Constructor* (1893), Section 257, pp. 167–171 (Figures 769-779). Movies of the cylinder escapement (Model X-2) and the three tooth escapement (Model X-3) can be seen on the KMODDL website.

12. The Verge Escapement

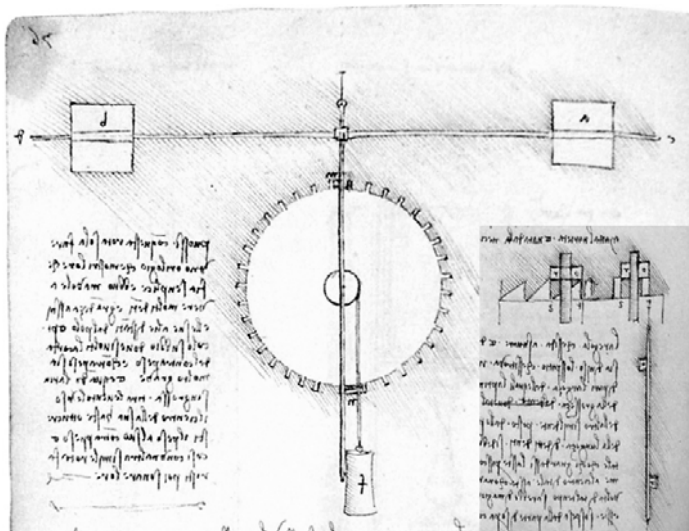

Figure III.12a. Verge clock escapement: *Codex Madrid I*, Folio 115v

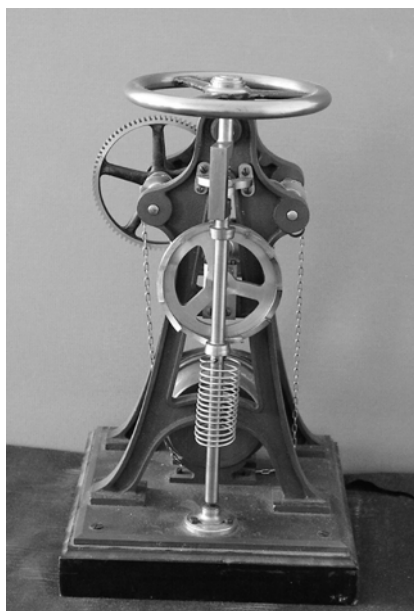

Figure III.12b. Verge and balance wheel escapement: Reuleaux–Voigt Catalog, Model X-1 (Cornell Collection of Kinematic Mechanisms)

13. Spur Gear Teeth

Toothed wheels transmit rotary motion from one wheel to another. These mechanisms have their origins in ancient technology. A classic design consisted of a lantern pinion and a larger gear with pin shaped teeth. This design had problems with wear of the teeth and uneven rotation of the gear when the pinion has constant speed. The shape of gear teeth occupied famous mathematicians such as L. Euler in the 18th century and Gibbs in the 19th century. Two geometric shapes of gear teeth that were discovered to transmit uniform motion were the *epicycloid* – generated by the rolling of a circle on a circle – and the *involute* – generated by the unwrapping of a string from a cylinder. The involute shaped gear tooth is the dominant design in gear technology today.

Leonardo da Vinci, *Codex Madrid I*, Folio 5r (see also Folio 116r)

Leonardo drew a number of gear designs based on the classic lantern pinion and pin shaped teeth (see e.g. Folio 19v). However in the two Folios above, he drew smooth shaped gear teeth closely shaped to the ideal epicycloid or involute. He seemed to have understood that variable contact radius between gear teeth would result in non-uniform rotation as reflected in the comments from Folio 5r and 116r:

The power of the motion made with the help of toothed wheels is not uniform because the teeth of the opposite wheel are sometimes touched by the tip, sometimes by the middle and sometimes by the beginning of the teeth of the wheel.

You who desire to make motions by means of toothed wheels, be aware that before embarking upon such an enterprise, you have to learn well, or rather perfectly, to proportion the toothing of the wheel to the toothing of its pinion, otherwise your effort would be in vain.

Leonardo also understood that the contact force between gears should act perpendicular to the line between the centers of the two gears. Although these observations show a remarkable understanding of modern gear theory, it does not appear that Leonardo was able to translate this knowledge into a mathematical theory of gear teeth.

Reuleaux–Voigt Model (Q-2)

Reuleaux designed a series of models to illustrate the theory of the shape of gear teeth (Q-1 to Q-8) and in particular the epicycloid and involute curves. The British engineer Robert Willis [1800–1875] of Cambridge University, showed that the involute curve, generated by the unwinding of a string on a cylinder, was a more universal shape that was more suited to the mating of gears of different diameters, as in speed change gear transmissions. However the epicycloid shaped gear tooth had advantages of generally being stronger than the involute shaped tooth. According to the machine design book of Mabie and Ocvirk (1963), involute gears have completely replaced epicycloid gears in power transmission, whereas the latter are still used in watches and clocks.

13. Spur Gear Teeth

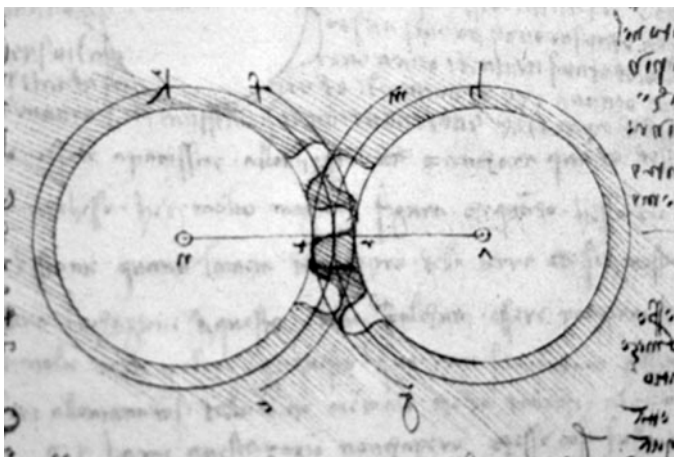

Figure III.13a. Pinion and spur gear teeth: *Codex Madrid I*, Folio 5r

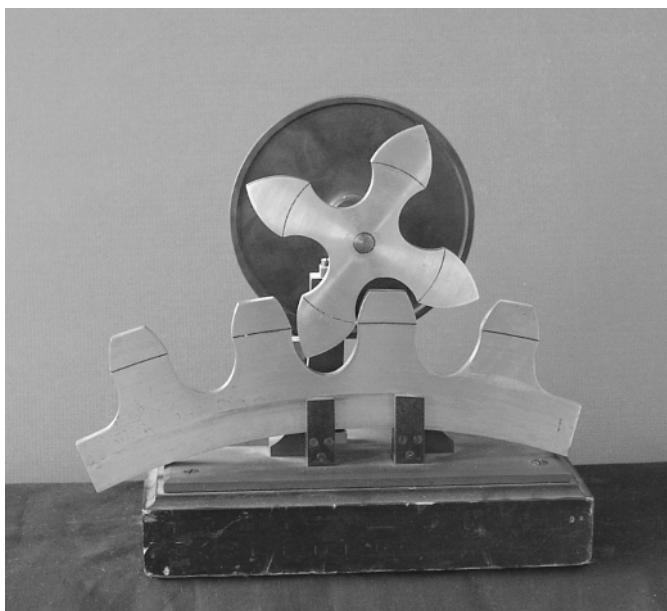

Figure III.13b. Involute spur gear teeth: Reuleaux–Voigt Catalog, Model Q-2 (Cornell Collection of Kinematic Mechanisms)

14. Rack and Pinion

The rack and pinion gear mechanism converts rotary motion about a pinion gear axis into linear motion along an axis perpendicular to the pinion axis. If the pinion axis is fixed, the rack must move and a prismatic guide is required and sometimes bearings between the rack and the guide to reduce friction. Bruton (1979) reports that Vitruvius (c. 25 BCE) described a rack and pinion in a water clock of Ctesibius. One modern application is in ink-jet printers in which the ink head system is moved back and forth as the paper is advanced.

Leonardo da Vinci, *Codex Madrid I*, Folio 35v (also Folio 13v)

In this drawing, Leonardo used a single-sided rack and pinion. The pinion is driven by four endless screw mechanisms. There is no text on this page. In other folios, Leonardo drives the rack teeth with a lantern pinion.

Besides the manuscripts of Leonardo, the rack and pinion can be found extensively in the machine and architecture books of Francesco di Giorgio. In the latter we see not only a rack with a pinion gear but also driven by a lantern pinion and even by a worm gear.

Leonardo also used two half toothed pinions and a linear rack to create a reciprocating rack motion as in Folio 2r of the *Codex Madrid I*.

Reuleaux–Voigt Model (Q-1)

Reuleaux discussed the shape of teeth in the rack and pinion in his *The Constructor* (1893, p. 132). He showed several types of gear teeth for the rack. In model Q-1 the teeth shape appear to be generated by an involute, while in Model Q-6 (see KMODDL) they are unsymmetrical. In his design book, Reuleaux drew the rack teeth with straight lines.

Reuleaux also used the toothed rack in linear ratchet systems as shown on page 151 of his *Constructor* (1893). By analogy Reuleaux envisioned the action of an undershot water wheel as similar to a fluid rack driving a toothed wheel (*Kinematics of Machinery*, 1876, p. 269). Examples of rack and pinion mechanisms may be found in the 1868 manual of Brown, *Five Hundred and Seven Movements* (Mechanisms #113, 114, 115, 116, 118). The rack and pinion can also be used for a mangle-rack with a half-toothed pinion for an reciprocating rectilinear motion. A video of a mangle-rack mechanism may be seen in the Clark model collection of the Boston Museum of Science on the KMODDL website, Model 79.

14. Rack and Pinion

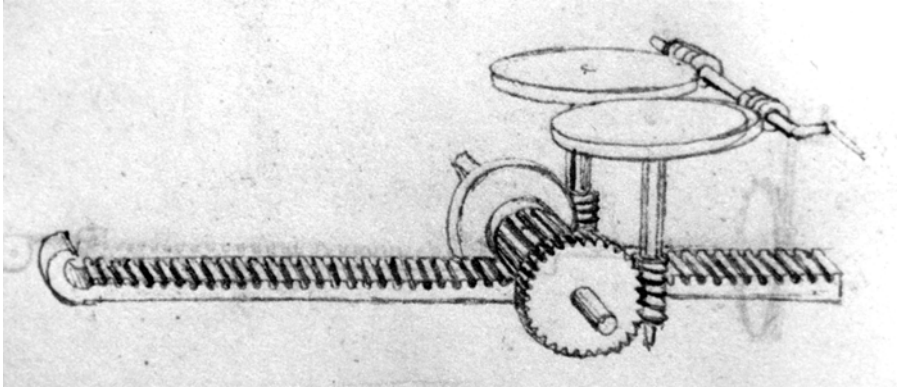

Figure III.14a. Single-sided rack and pinion: *Codex Madrid I*, Folio 35v

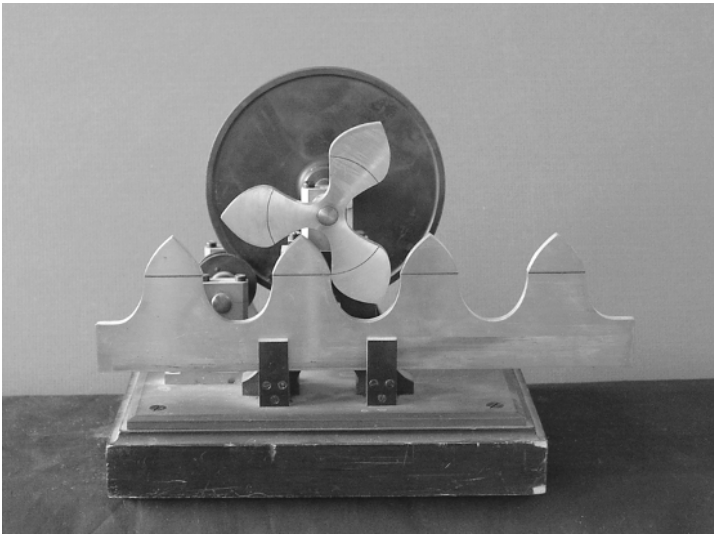

Figure III.14b. Rack and pinion gear teeth: Reuleaux–Voigt Catalog, Model Q-1 (Cornell Collection of Kinematic Models)

15. Planetary or Epicyclic Gear Systems

Gear mechanisms convert rotary speed and torque about one axis into a complimentary speed and torque about another axis. The simplest gear train with two parallel axes of motion is the spur gear and pinion set, with two gears and a link between the axes of rotation. In standard operation, the link is grounded and the two gears turn about fixed axes. But in some applications, one gear can be fixed (the ‘sun’ gear) and the link or arm can rotate. In this case the other gear rolls on the outside of the ‘sun’ gear and is called a ‘planet’ gear. Points on the planet gear generate mathematical curves called *epicycloids*. In epicyclic gear systems, one can also have a ‘ring’ or annulus gear outside the planet gear. The rolling of a circle on the inside of another circle generates curves called *hypocycloids*. A planetary gear system was invented by James Watt to convert oscillating or rocking motion in his steam engine into rotary motion in a flywheel (see Section II.14). Planetary gear systems are also used in modern servo-motors for robotic applications as well as in automotive transmission systems and aircraft propeller drives.

Leonardo da Vinci, *Codex Madrid I*, Folio 13v

The planetary gear system in Leonardo’s Folio 13v in his *Codex Madrid I*, consists of three planet gears and a ring gear. In the sketch, Leonardo fixes the three axes of the planet gears and rotates the ring gear about the center axis. This example appears to be somewhat pedagogical in that Leonardo uses it to describe relative motions of the gears. In his notes he wrote:

when the big wheel rotates, pinions ‘a’ and ‘n’ will revolve in opposite directions.
The big wheel and pinion ‘n’ turn in the same direction.

There is no mention of any application of this gear mechanism. Leonardo liked to design with a wide variety of gear systems. He had a wider gear vocabulary than Francesco di Giorgio, his older contemporary (see also Figure II.24).

Reuleaux–Voigt Model (G-2)

Reuleaux designed a set of seven models in the Voigt model G Series to illustrate several types of planetary gear systems. He also designed a pedestal (Model H-1) to be able to ground any of the elements in the kinematic chain such as the sun, planet, arm or annulus gear in order to demonstrate the relative motions of all the parts. Model G-2, shown in the photo, is a sun-planet-annulus system. On its model base, the arm is fixed and rotation of the ring gear will drive both the planet and sun gears. If the arm link is not fixed, the basic epicyclic gear train is a two input mechanism. Planetary systems of the sun-planet-annulus variety can create a wide range of speed reductions on a single axis and are often chosen for their space efficiency in applications (Paul, 1979, p. 81).

Oddly Reuleaux has no discussion of planetary gear systems in his practical handbook *The Constructor* of 1893, but discussed Watt’s sun and planet transmission in *Kinematics of Machinery* (1876, p. 176, Figure 234; p. 433, Figure 284) He also discussed systems with sun and planet gears in a four-bar linkage (p. 575, Figure 432) along with Model O-1 in the Voigt Series. He also designed sun and planet systems within a slider-crank kinematic chain; Voigt Models O-2 to O-5.

15. Planetary or Epicyclic Gear Systems



Figure III.15a. Planetary-epicyclic gear train: *Codex Madrid I*, Folio 13v

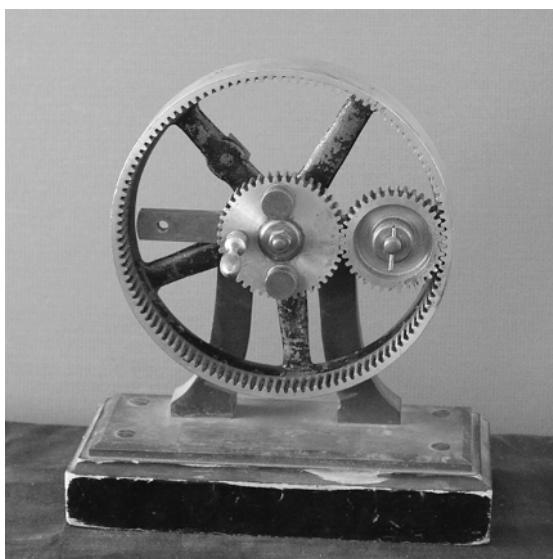

Figure III.15b. Planetary-epicyclic gear train: Reuleaux–Voigt Catalog, Model G-2 (Cornell Collection of Kinematic Mechanisms)

16. Bevel Gears and Conical Friction Wheels

Bevel gears are used to transfer rotary motion from one axis to another axis that intersects with the first. The kinematic motion of the two interacting toothed wheels is the same as the rolling of one cone on another. Hence conical friction wheels and bevel gears have similar kinematic properties and generate spherical cycloid curves in space as one rolls on the other.

Leonardo da Vinci, *Codex Madrid I*, Folio 96r

Leonardo called this gear '*dentatura piramidata*' or pyramidal teeth. Next to the drawing he wrote that the teeth were more durable because there is greater contact between the pinion and the gear. He also noted that the teeth do not wear evenly suggesting that he knew of an application or had some experience with the use of this gear design. The design of the teeth for this period of the Renaissance was unusual. For rotary motion about two axes at 45 degrees say, typical gear designs used lantern pinions and a crown wheel with pin teeth as can be seen in many of Leonardo's drawings and those of contemporaries such as Francesco di Giorgio (see e.g. Figures II.10, II.24). The cylindrical rods on the pinions engaged similar rod-like teeth on the crown wheel, resulting in high stresses and high wear. In the design of Folio 96r, the point contact of the pin teeth is replaced with a line contact and hence lower stresses and wear.

Reuleaux Model: Deutsches Museum

The brass conical wheels shown here are from Reuleaux's Berlin model collection and were sent after his death to the new Deutsches Museum in Munich. Thus they were not destroyed in the bombing of Berlin in WWII. These models were not part of the Voigt catalog and were not reproduced. They are particularly beautiful brass sculptural works. There are several that illustrate conical friction wheel motion as in bevel gears. Reuleaux did create another set of conical rolling models in the Voigt catalog in the 'R' Series (R-1 to R-6). These are also interesting in that he shows the spherical cycloidal curves that are traced when one bevel gear rolls on another. These models can be seen in motion on the KMODDL website.

Like spur gears, bevel gears can be used in a planetary gear system with similar properties of epicycloid gear trains. One of the principle applications of bevel gear planetary gear trains is in automotive transmissions.

16. Bevel Gears and Conical Friction Wheels

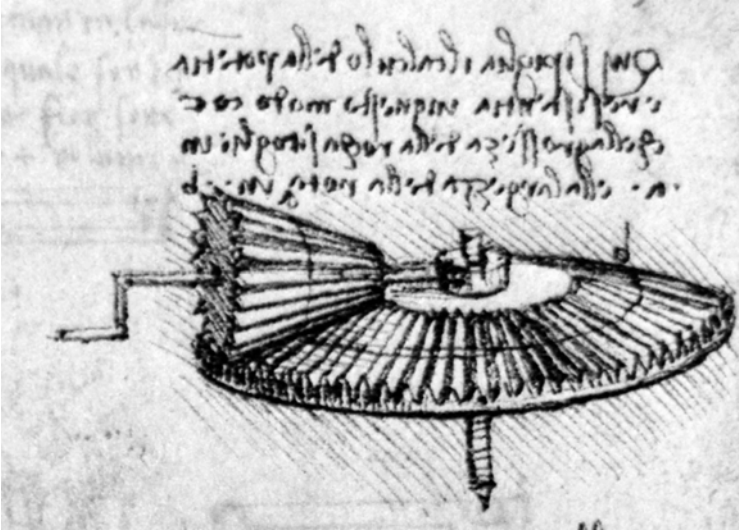

Figure III.16a. Bevel gears: *Codex Madrid I*, Folio 96r



Figure III.16b. Conical friction wheels: Reuleaux Model, Deutsches Museum (c. 1880)

17. Friction Wheels

The transmission of motion between one axle and another can be made through toothed wheels or gears, belt or rope coupling or by the use of friction wheels. The basic principle is that the surface or edge contact of one wheel with another will constrain the two surfaces to have the same velocity provided that there is no slip between the surfaces. This requires a certain amount of pressure between the surfaces in order to generate friction forces between the two wheels. The continuous contact and resulting motion has advantages over toothed or geared wheels in that there is no engaging and disengaging of gear teeth, hence less noise and wear. The friction wheel has the disadvantage of limited torque to avoid slipping between the wheels. A modern application of friction wheels is in video and audiotape drive mechanisms.

Leonardo da Vinci, *Codex Madrid I*, Folio 113v (see also Folios 101v, 102r)

In this drawing, Leonardo used friction wheels as a way of supporting a rotating load with little friction. This could be thought of as a thrust bearing. The high velocity of the central shaft is transferred to the lower velocity of the friction wheels, which presumably results in a lower energy loss. In Folio 101 v, he used three spherical balls to act as a thrust bearing. The text in Folio 113v reads (Reti, 1974):

This is a method of reducing friction in an axle placed upright on its support. The friction is discharged from the axle m and transferred to the 2 axles n and f. The larger the circumference of the supporting wheels, the easier will be the motion of the motor.

Reuleaux–Voigt Model (Y-10) (see also Voigt model W-5)

Reuleaux designed a half dozen models with friction wheels. In model Y-10, he used three friction wheels for a variable speed drive. Another model (W-5), transfers motion from a high-speed axle to a slower wheel with an axle perpendicular to the driving wheel. In another beautiful Reuleaux model in the Deutsches Museum collection, two brass hyperbolas of revolution transmit motion by friction contact in which the axes of rotation are skew to each other. Because friction wheels and clutches require some force contact, Reuleaux called friction wheels ‘*force-closed systems*’ in contrast to pure geometric mechanisms.

Reuleaux summarized a lot of design information about friction wheels in *The Constructor* (1893), in Chapter XVI. He discussed friction wheels for parallel axes, inclined axes and wedge friction wheels used in clutches.

17. Friction Wheels

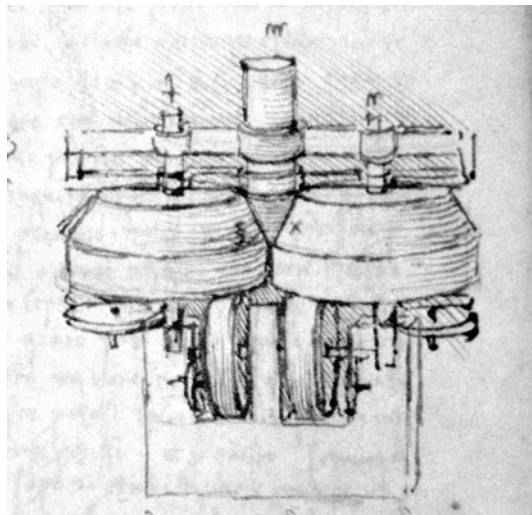

Figure III.17a. Friction wheels: *Codex Madrid I*, Folio 113v

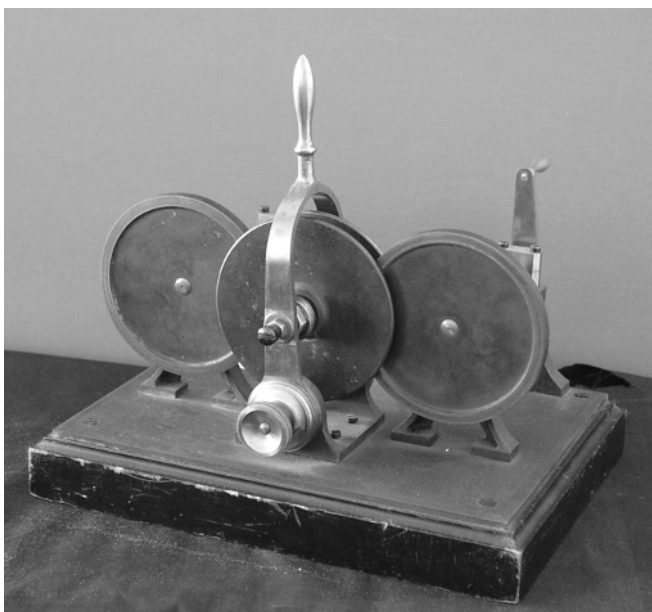

Figure III.17b. Variable-ratio, friction wheel clutch: Reuleaux–Voigt Catalog, Model Y-10 (Cornell Collection of Kinematic Mechanisms)

18. Cam Mechanism

Cam mechanisms transmit motions from a rotating body to another body through the sliding contact of the cam and the cam follower. For example, in traditional automobile engine design, a rotating camshaft provides lift motion to the engine valves timed to the motion of the pistons. The geometric configuration of the rotating and follower elements can have many shapes and topologies. In some cases the contact between cam and follower is continuous while in other cases there is intermittent contact or even impulsive, transient contact. In most cases the shape of the cam is designed to impart a specific motion to the follower such as constant velocity, as in some sewing machines, or sinusoidal motion requiring detailed mathematical calculation of the cam shape.

Leonardo da Vinci, *Codex Madrid I*, Folio 6v (see also, Folios 7r, 8r, 28v)

Leonardo drew several different cam mechanisms some with continuous contact and others with intermittent contact. The drawing to the right, shows a cam and lever follower to lift a hammer smoothly and suddenly drop it. This was likely designed for either a metal processing machine or a textile fulling process. There is no textual comment on this page. The cam in Folio 8r, is a continuous groove with a pin follower and Leonardo writes that it may be used in a clock escapement and that 'it is noiseless'. The cam in Folio 7r is of the impact type. Cam mechanisms were to be found in other machine books of the period both before and after the time of Leonardo. The pin follower cam of Folio 28v is called a grooved-cam in Brown (1868) (#106, #107). A movie of a grooved cam or drum cam from the Boston Museum of Science kinematic model collection (#64) can be seen on the KMODDL website.

Reuleaux–Voigt Model (L-2)

The cam mechanism shown in this model is known as a positive return cam mechanism. The shape of the cam, known as a curved triangle, was used in the early days of the steam engine to control the opening and closing of the valves. The curved triangle is known as a curve of constant width and produces a dwell period at the beginning and end of the cam cycle. Reuleaux described many different cam shapes of constant breadth in his book *Kinematics of Machinery* (1876), and designed six positive return models in the Voigt catalog. Although the curved triangle cam was known before the time of Reuleaux, in recent years, mathematicians have called this shape a *Reuleaux triangle*.

18. Cam Mechanism

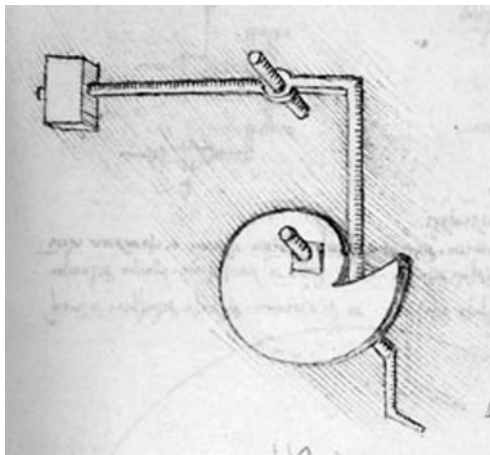

Figure III.18a. Cam actuated lever: *Codex Madrid I*, Folio 6v



Figure III.18b. Positive-return cam with Reuleaux triangle: Reuleaux–Voigt Catalog, Model L-2 (Cornell Collection of Kinematic Mechanisms)

19. Water Wheels and Pumps

Water wheels are ancient machines that were designed with great variety. They were used as either a power source, taking energy from a moving stream or river, or, if powered by human or animal labor, were used to pump water from one lower level to a higher one. Water wheels without a surrounding chamber were often used as prime movers. Pump wheels were often contained inside a chamber that helped guide the flow of the fluid. In modern auto engines, pumps are used to pump the fuel and power the brakes. In modern water power machines, turbines have replaced the water wheel. Other non rotary or wheel-type water lifting devices of antiquity include the chain of buckets and the Archimedes screw pump and the oscillating piston pump.

Leonardo da Vinci, *Codex Madrid I*, Folio 142r (see also folio 22v)

Leonardo da Vinci described the design of impulse water wheels for driving power in mill-works. In the impulse type water wheel the momentum of falling water is transferred to the water wheel by means of ratchet-like buckets around the circumference of the wheel as shown in the figure to the right. The translation of the text alongside this figure reads (Reti, 1974);

—the weight of the water remains upon the wheel after the percussion, it is sure that a wheel moved by these powers will have great velocity and power.

In the text with the drawing in Folio 22v, Leonardo recognizes that the torque on the wheel is generated by both the static weight of the water in the buckets but also by the momentum or velocity of the flow.

—you cannot deny that once the water fills up one of the buckets, it confers all of its weight to the side of the wheel where it is placed. And to this, there is the added percussion of the water falling on the bucket, meaning 2 forces joined together, that is percussion and weight.

Designs for rotary, chamber-wheel pump-engines can be found in Ramelli's 1588 'theatre of machines' book.

Reuleaux–Voigt Model (I-7)

Reuleaux's pump wheels in his model collection are by contrast to Leonardo of the chamber wheel type. In Voigt Model I-7, called a Behrens–Dart pump, there are two wheel-like elements, geared from behind, and synchronized to push the fluid from the bottom to the top. This type of pump is known as a displacement pump. In the 18th and 19th century, pumps were also designed to blow air into mines as well as to stoke iron furnaces. Reuleaux designed 16 rotary pump-engine models for the Voigt catalog. In Chapter IX of his *Kinematics of Machinery* (1876), he discussed several dozen so-called chamber wheel trains. Model I-7 was patented by Behrens and made by the Dart company of New York. It was exhibited at the Paris Exhibition of 1867. In a demonstration one device was designed as a 12 HP steam engine that drove another Behrens–Dart pump. This design had advantages of lower leakage over gear teeth pumps because of surface contact of the moving parts.

19. Water Wheels and Pumps



Figure III.19a. Water wheel: *Codex Madrid I*, Folio 142r

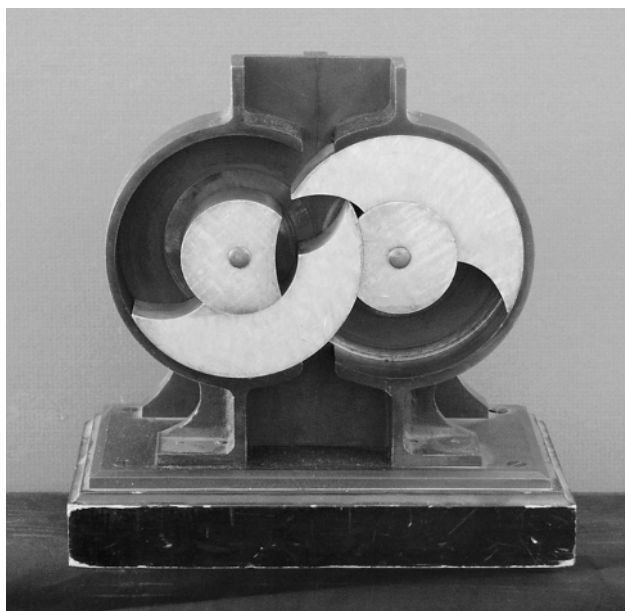

Figure III.19b. Behrens–Dart pump and steam engine of 1867: Reuleaux–Voigt Catalog, Model I-7 (Cornell Collection of Kinematic Mechanisms)

20. Flywheels and Balance Wheels

Flywheels are used to store kinetic energy in machines. Two widespread applications were as a flywheel in steam or gas engines and as a balance wheel in clocks. In both steam and gas engines the power is generated cyclically in the linear motion of the pistons. This oscillating energy is transferred to the flywheel, which rotates in one direction and serves to smooth out the motion. Balance wheels in clocks on the other hand take steady energy of a falling weight or a wound spring and help turn it into oscillating motion that is used to count or mark the passage of time.

Leonardo da Vinci, *Codex Madrid I*, Folio 114r

This drawing provides graphic evidence of Leonardo's understanding of centrifugal acceleration and the storage of kinetic energy flywheels. The text with these sketches reads:

Why do weights which hang perpendicularly at the beginning and at the end [of the motion] take up, together with their chains, a horizontal line while they are in motion?

—It seems that the balls hanging from these chains desire to go as far away as possible from the center of their power, and this is why the chains take up a horizontal position.

The text gives few clues as to the intended application. However there is mention of water wheels or pumps. Also at the bottom of the page he wrote that the solid disc flywheel “*moves with more ease than any other*”. A ball and chain inertia wheel can also be found in the machine drawings of Francesco di Giorgio Martini.

Reuleaux–Voigt Model (N-27)

Reuleaux designed a number of Voigt models to represent regulators in machines. Several were to use the flywheel shown in Model N-27. Machines with flywheels are not pure mechanisms in Reuleaux's theory of machines. The motion of pure mechanisms depends only on the geometric constraints between the parts. However machines with flywheels, such as in clocks and steam engines, are governed by Newton's laws of motion in addition to the geometric constraints. In spite of this inconsistency in Reuleaux's theory of machines, he constructed four clock escapements with balance wheels that are not pure mechanisms. In *The Constructor* (1893), Reuleaux acknowledged that flywheels constituted a special class of machine elements.

Many mechanisms, such as the slider-crank, have singular configurations that Reuleaux called ‘*dead points*’. In *Kinematics of Machinery* (1876, Chapter V), he comments on the role of flywheels to move the mechanism through these ‘*dead points*’:

—in the steam engine, — everyone is familiar with the flywheel, — rigidly connected with the crank which is so often used for passing the dead points. The flywheel furnishes the sensible force required to continue the motion of the machine—

20. Flywheels and Balance Wheels

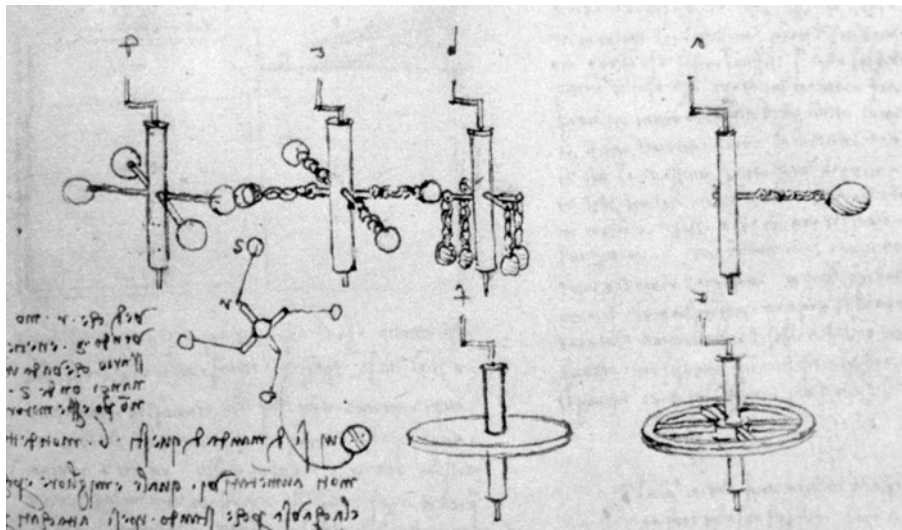

Figure III.20a. Flywheel designs: *Codex Madrid I*, Folio 114r



Figure III.20b. Flywheel or balance wheel: Reuleaux-Voigt Catalog, Model N-27 (Cornell Collection of Kinematic Mechanisms)

PART IV

References, Bibliography & Appendices

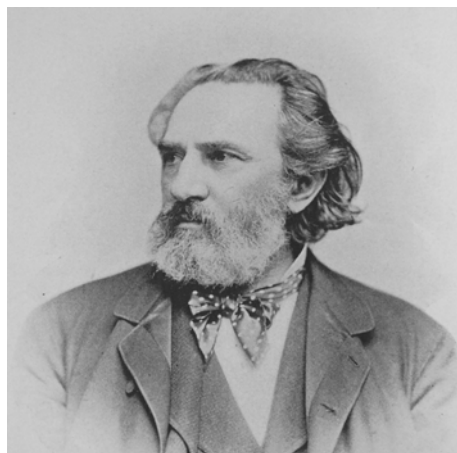
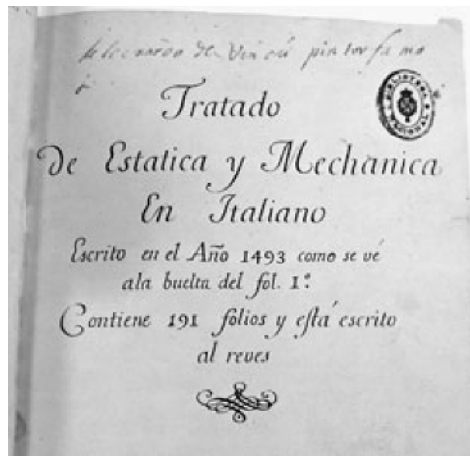

Leonardo da Vinci:

“Among the superfluous and impossible delusions of man there is the search for continuous motion, called by some perpetual wheel. For many centuries almost all those who worked on hydraulic and war machines, and other subtle engines, dedicated much research and experimentation to this problem, incurring great expense. But finally, the same always befell the alchemists: for a small detail everything was lost”

[*Codex Madrid I*, Folio O recto; transl. L. Reti.]

Franz Reuleaux:

“Kinematic synthesis may also be called a theory of the invention of mechanisms. This it can only be in a limited sense. It can in no case enable the genius of the inventor to be dispensed with but by the aid of this theory his scope can be greatly extended.”

[*The Constructor*, 4th Ed., p. xi; transl. H.H. Suplee.]

IV

References, Bibliography & Appendices

Cited References

- Agricola, G. (1556) *De Re Metallica*, Transl. H.C. Hoover and L.H. Hoover in 1912, Dover Publ. Inc., New York, 1950.
- Al-Jazari, Ibn al-Razzaz (1204–1206) *The Book of Knowledge of Ingenuous Mechanical Devices*, Translated and Annotated by Donald R. Hill, D. Reidel Publ. Co., Boston, 1974.
- Alberti, Leon Battista (1452, 1485) *De re aedificatoria* (On the Art of Building).
- Ampere, A.-M. (1838) *Essai sur la philosophie des sciences, une exposition analytique d'une classification naturelle de toutes les connaissances humaines*, 2 vols., Paris.
- Archimedes: See Dijksterhuis (1938, 1987).
- Aristotle, *Minor Works, Mechanica*, Edited by W.S. Hett (1936).
- Aronhold, S.H. (1872) Grundzüge der kinematische Geometrie, *Verhandlungen des Vereins zur Beförderung des Gewerbeleisses in Preussen* **29**, 129–155.
- Artobolevsky, I.I. (1975, 1979) *Mechanisms in Modern Engineering Design*, 5 vols. (2288 mechanisms), Mir Publishers, Moscow.
- Atalay, B. (2004) *Math and the Mona Lisa*, Smithsonian Books, Washington, DC.
- Babbage, C. (1826) On a Method of Expressing by Signs the Action of Machinery, *Phil. Trans. Royal Soc.* **116**, 250–265, in *The Works of Charles Babbage*, M. Campbell-Kelly (Ed.), Vol. 3, William Pickering, London, 1989.
- Babbage, C. (1851) Laws of Mechanical Notation (London), in *The Works of Charles Babbage*, M. Campbell-Kelly (Ed.), Vol. 3, William, Pickering, London, 1989.
- Bacon, Roger (c. 1266) *Epistola de Secretis Operitus Artis et Nature*.
- Barr, J.H. and Wood E.H. (1916) *Kinematics of Machinery*, 2nd Edition, J. Wiley & Sons, New York.
- Bassala, G. (1988) *The Evolution of Technology*, Cambridge University Press.
- Battisti, E. (1981, 2002) *Filippo Brunelleschi*, Rizzoli Int'l Publ., New York, 1981, Electra Architecture, Milan, 2002.
- Beck, T. (1899) *Beiträge zur Geschichte des Maschinenbaues*, Julius Springer, Berlin.
- Bennett, G.T. (1905) The Parallel Motion of Sarrut and Some Allied Mechanisms, *Phil. Mag.* **9**, 803–810 (6th Series, June).

- Bennett, S. (1979) *A History of Control Engineering 1800–1930*, Institution of Electrical Engineers, London, Peter Peregrinus Ltd., Stevenage, UK.
- von Beohn, M. (1932) *Dolls and Puppets* (Translation of Puppen und Puppenspiele). Translated by J. Nicoli, McKay, Philadelphia.
- Bernheim, C. (1995) *Picabia*, Editions du Félin, Paris.
- Besson, J. (1571, 1578) *Theatre des Instruments*.
- Bevan, T. (1939, 1956) *The Theory of Machines*, Longmans, Green and Co, London 3rd Edition, pp. 147–149 (1st Edition, 1939).
- Bickford, J.H. (1972) *Mechanisms for Intermittent Motion*, Industrial Press Inc., New York.
- Biringuccio, Vannuccio (1540) *De la Pirotechnia*.
- Böckler, Georgius Andreas (1661) *Theatrum Machinarum Novum*.
- Borgnis, J.A. (1818) *Traite Complet De Mechanique Applique aux Arts: Composition des Machines*, Bachelier Librairie, Quai des Augustins, Paris.
- Bottema, O. (1953) Recent Works in Kinematics, *Applied Mechanics Reviews* **6** (April), 169–170.
- Branca, Giovanni (1629) *Le Machine*, Rome.
- Braun, H.J. (1990) Franz Reuleaux, in *Berlinische Lebensbilder*, Band 6 Techniker, W. Treue and W. König (Eds.), Colloquium Verlag, Berlin, pp. 279–292.
- Braun, H.J. and Weber, W. (1979) Ingenieurwissenschaft und Gesellschaftspolitik: Das Wirken von Franz Reuleaux (Engineering Science and Corporate Politics: The Work of Franz Reuleaux), *Technik und Gesellschaft* **1**, 285–300.
- Brose, E.D. (1998) *Technology and Science in the Industrializing Nations, 1500–1914*, Humanities Press, NJ.
- Brown, H.T. (Ed.) (1868) *Five Hundred and Seven Mechanical Movements*, Brown, Coombs & Co, New York.
- Bruton, E. (1967) *Clocks and Watches 1400–1900*, Barker, London.
- Buckingham, E. (1949) *Analytical Mechanics of Gears*, McGraw-Hill, New York.
- Burckhardt, J. (1860) *Die Kultur der Renaissance en Italien* (The Civilization of the Renaissance in Italy), 2002 Edition, Modern Library, Random House, New York.
- Burmester, L. (1888) *Lehrbuch der Kinematik*, Leipzig.
- Burstall, A.F. (1965) *A History of Mechanical Engineering*, The MIT Press, Cambridge, MA.
- Bush, V. (1931) The Differential Analyzer. A New Machine for Solving Differential Equations, *J. The Franklin Institute* **212**, 1267–1272, July–Dec. 447–488.
- Butler, S. (1872) *Erewhon*, Penguin Books, London.
- Calvert, M. (1967) *History of Mechanical Engineering*, J. Hopkins Press.
- Cambridge University Engineering Department (2000), The Reverend Robert Willis 1800–1875, *Engineering* **125**, 3.
- Canestrini, G. (c. 1956) Leonardo's Machines, in *Leonardo da Vinci*, Reprint of the 1938 Milan Exhibition Lectures on Leonardo da Vinci, Reynal & Company, New York.
- Carnegie, A. (1905) *James Watt*, Doubleday Page & Co., New York.
- Carnot, Lazare (See Gillispie, 1971).
- Ceccarelli, M. (1998) Mechanism Schemes in Teaching: A Historical Overview, *J. Mechanical Design* **120**, 533–541.
- Ceccarelli, M. (Ed.) (2000) *International Symposium on History of Machines and Mechanisms*, Proceedings HMM 2000, Kluwer Academic Publ., Dordrecht.
- Ceccarelli, M. (2000) Italian Kinematic Studies in XIXth Century, in *International Symposium on the History of Machines and Mechanisms*, M. Ceccarelli (Ed.), Kluwer Academic Publ., Dordrecht, pp. 197–206.

- Ceccarelli, M. (Ed.) (2004) *International Symposium on the History of Machines and Mechanisms*, Kluwer Academic Publ., Dordrecht.
- Ceccarelli, M. (2006) Early TMM in Le Meccaniche by Galileo Galilei in 1593, *Mechanism and Machine Theory* **41**, 1401–1406.
- Ceccarelli, M. and Cigola, M. (2001) Trends in the Drawing of Mechanisms Since the Early Middle Ages, in *Proc. Institution of Mechanical Engrs.*, Vol. 215, Part C, pp. 269–289.
- Chanute, O. (1894) Progress in Flying Machines, *The American Engineer and Railroad Journal*, New York.
- Chasles, M. (1837) *Aperçu Historique des Methodes en Geometrie*, M. Hayez, Imprimeur de l'Academie Royale, Brussels. (Translated into German L.A. Sohncke, 1839.)
- Chebyshev, P.L. (1899–1907) *Oeuvres de P.L. Tchebychef*, 2 Vols., St Petersburg. See also *Scientific Contributions of P.L. Chebyshev, Second Part: Theory of Mechanisms*, I. Artobolevsky (Ed.), Academy of Science USSR, 1945, Moscow [in Russian].
- Cialdi, Alessandro (1873) *J. Politecnico*, Nr. 3, Milano.
- Cianchi, M. (c. 1995) *Leonardo's Machines*, Becocci Editore, Florence.
- Clagett, Marshall (1959) *The Science of Mechanics in the Middle Ages*, The University of Wisconsin Press, Madison/Oxford University Press, London.
- Clark, K. (1939, 1959) *Leonardo da Vinci*, Revised Edition, Penguin Books, London.
- Clark, W.M. (1943) *A Manual of Mechanical Movements*, Garden City Publishing Co., Garden City, New York.
- Collins, S., Ruina, A., Tedrake, R. and Wisse, M. (2005) Efficient Bipedal Robots Based on Passive-Dynamic Walkers, *Science* **307** (18 Feb.), 1082–1085.
- Cooper, M. (1965) *The Inventions of Leonardo da Vinci*, The Macmillan Co., New York.
- Craig, J.J. (2005) *Introduction to Robotics*, 3rd Ed., Pearson Prentice Hall, New Jersey.
- Cuomo, S. (2000) *Pappus of Alexandria and the Mathematics of Late Antiquity*, Cambridge University Press, Cambridge, UK.
- Dasgupta, S. (1996) *Technology and Creativity*, Oxford University Press, New York.
- Daumas, M. (1962, 1969) *A History of Technology and Invention: Progress Through the Ages*, Vols. 1 and 2, Crown Publishers, New York [Translated from the French].
- Davies, C. (1859) *Elements of Descriptive Geometry*, A.S. Barnes & Co., New York.
- De Caus, Salomon (1615) *Le Raisons des Forces Mouvantes, Avec Diverses Machines Tant Utiles Que Plaisantes*, Frankfurt.
- Deleuil (1865) *Catalog of Scientific and Mathematical Apparatus*, Paris.
- deSolla Price, Derek J. (1959) An Ancient Greek Computer, *Scientific American*, pp. 60–67.
- Diamond, Jared (1999) *Guns, Germs and Steel*, W.W. Norton, New York.
- Dibner, B. (c. 1974) *Leonardo da Vinci, Machines and Weaponry*, Burndy Library, Norwalk Conn.
- Dibner, B (1969) Leonardo: Prophet of Automation, in *Leonardo's Legacy*, C.D. O'Malley (Ed.), University of California Press, Berkeley.
- Diderot, D. and D'Alembert, J. (1751–1772) *Encyclopedia*, Paris.
- Dijksterhuis, E.J. (1938, 1987) *Archimedes: Engineer-Mathematician*, Princeton University Press, Princeton, NJ.
- diLuzzi, Mondino (1316) *Anathomia*, Bologna, Italy.
- Dimarogonas, A.D. (1993) The Origins of The Theory of Machines and Mechanisms, in *Modern Kinematics*, A.G. Erdman (Ed.), J. Wiley & Sons, New York, Section 1.2.
- Drachmann, A.G. (1963) *The Mechanical Technology of Greek and Roman Antiquity*, Munksgaard, Copenhagen.
- Dudley, D.W. (1969) *The Evolution of the Gear Art*, American Gear Manufacturers Assoc., Washington, DC.

- Dugas, R. (1955, 1988) *A History of Mechanics*, Dover Publications, New York.
- Duhem, Pierre (1906–1913) *Etudes sur Leonard de Vinci*, 3 Vols., A. Hermann, Paris (Reprinted De Nobele, Paris 1955).
- Dunkerly, S. (1910) *Mechanism*, Longmans, Green, and Co., London.
- Durley, R.J. (1907) *Kinematics of Machines*, J. Wiley & Sons, New York.
- Eco, U. and Zorzoli, B.G. (1963) *The Picture History of Inventions*, The MacMillan Co. New York.
- Emerson, R.W. (1940, 1950) *The Complete Essays and Other Writings of Ralph Waldo Emerson*, Brooks Athenson (Eds.), The Modern Library, New York, pp. 521–690.
- Endrei, W.G. (1968) The First Technical Exhibition, *Technology and Culture* 9(2) (April).
- Erdman, A.G. (Ed.) (1993) *Modern Kinematics; Developments in the Last Forty Years*, J. Wiley & Sons.
- Erdman, A.G. and Sandor, G.N. (1997) *Mechanism Design: Analysis and Synthesis*, Third Edition, Prentice Hall, Upper Saddle River, NJ.
- Erlande-Brandenburg, A. (1995) *Cathedrals and Castles: Building in the Middle Ages*, Harry D. Abrams, New York.
- Errard de Bar-Le-Duc, Jean (1584) *La Premier Livre des instruments mathematiques mechaniques*, Nancy (Facsimile edition, 1979, Berger-Levrault, Paris).
- Essinger, J. (2004) *Jaquard's Web*, Oxford University Press, Oxford.
- Evans, Oliver (1805) *The Abortion of the Young Steam Engineer's Guide* (Reprinted by The Oliver Evans Press, 1990).
- Farey, J. (1827) *Treatise on the Steam Engine, Historical, Practical, Descriptive*, London.
- Feldhaus, F.M. (1922) *Leonardo, der Techniker und Erfinder*, E. Diederichs, Jena.
- Feldhaus, F.M. (1953) *Geschichte des technischen Zeichnens* (History of Technical Drawing) [in German].
- Feldhaus, Franz M. (1954) *Die Maschine im Leben der Völker: Ein Überblick von der Urzeit bis zur Renaissance*, Birkhäuser, Basel.
- Ferguson, E.S. (1962) Kinematics of Mechanisms from the Time of Watt, *United States National Museum Bulletin* 228, Paper 27, 185–230.
- Ferguson, E.S. (1977) The Mind's Eye: Nonverbal Thought in Technology, *Science* 197 (No. 4300), 827–836.
- Ferguson, E.S. (1992) *Engineering and the Mind's Eye*, MIT Press, Cambridge, MA.
- Fontana, Giacomo [1393–1455] *Bellicorum Instrumentorum Liber*, Venice, Italy,
- Francesco di Giorgio Martini (c. 1450) *Tratatto di Architectura (Facsimile: Architettura Ingegneria e Arte Militare: Codici Torinese Saluzziano 148*, Corrado Maltese (Ed.) (Transcription, Livia M. Degrassi, Edizioni Il Polifilo, Milano, 1967).
- Francesco di Giorgio Martini (c. 1450) Translation of Vitruvius (see Scaglia, 1985).
- Freudenstein, F. (1959) Trends in Kinematics of Mechanisms, *Applied Mechanics Reviews* 12 (September), 587–590.
- Galileo, Galilei (c. 1600) *Le Meccaniche*, in *Galileo Galilei on Motion and on Mechanics*, Translated by Stillman Drake, The University of Wisconsin Press, Madison, 1960.
- Galluzzi, P. (Ed.) (1991) *Prima di Leonardo: Cultura delle machine e Siena nel Rinascimento*, Electa, Milano.
- Galluzzi, P. (1997) *Mechanical Marvels: Invention in the Age of Leonardo*, Guinti Press Florence, Italy.
- Gardner, M. (1969) *The Unexpected Hanging and Other Mathematical Diversions*, A Touchstone Book Simon & Schuster, Inc., New York, Chapter Eighteen: 'Curves of Constant Width', pp. 212–221 and 254.

- Ghiberti, Bonaccorso (c. 1480–1490) *Zibaldone* (On-line at www.bncf.firenze.sbn.it/Bib_digitale).
- Gibbs-Smith, C.H. (1967) *Leonardo da Vinci's Aeronautics*, Science Museum, Her Majesty's Stationary Office, London.
- Gibbs-Smith, C.H. (1978) *The Inventions of Leonardo da Vinci*, Phaidon Press, Oxford.
- Gies, F. and Gies, J. (1994) *Cathedral, Forge and Waterwheel, Technology and Invention in the Middle Ages*, Harper Collins Publishers, Inc., New York.
- Gille, B. (1966) *The Renaissance Engineers*, Lund Humphries, London.
- Gillispie, C.C. (Ed.) (1970) *Dictionary of Scientific Biography*, Charles Scribners & Sons, New York, Vol. XI (see Reuleaux, Franz, by Otto Mayr, 383–385).
- Gillispie, C.C. (1971) *Lazare Carnot Savant*, Princeton University Press, Chapter II, 'The Science of Machines', pp. 31–61.
- Gimpel, Jean (1976) *The Medieval Machine, The Industrial Revolution of the Middle Ages*, Holt, Rinehart, Winston, New York.
- Goldberg, M. (1948) Circular Arc Rotors in Regular Polygons, *American Math. Monthly* **55**(7), 393–402.
- Gradenwitz, A. (1908) The Mutual Relations of Geometry and Mechanics and Prof Reuleaux's Mechanical Movements, *Scientific American*, March 21, 204–205.
- Graf von Seherr-Thoss, C. (1965) *Die Entwicklung Der Zahnrad-Technik*, Springer-Verlag, Berlin.
- Grafton, Anthony (2000) *Leon Battista Alberti: Master Builder of the Italian Renaissance*, Harvard University Press, Cambridge.
- Grese, M.A. and Poggio, T. (2003) Neural mechanisms for the recognition of biological movements, *Nat. Rev. Neuroscience* **4**, 179–192.
- Grossman, E.D., Blake, R. and Kim, C-Y. (2004) *J. of Cognitive Neuroscience* **16**(9), 1669–1679.
- Grothe, H. (1874) *Leonardo da Vinci als Ingenieur und Philosoph; Ein Beitrage zur Geschichte der Technik und der Inductiven Wissenschaften*, Nicolaische Verlag-Buchhandlung, Berlin.
- Grothe, H. (1877) *Industrie in Amerika's*, Burmester & Stempell, Berlin.
- Grübler, M. (1917) *Getriebelehre*, Verlag von Julius Springer, Berlin.
- Grübler, M. (1883) *Der Civilingenieur*.
- Giulio (1847) *Cinematica applicata alle arti* (see Reuleaux, 1876a, p. 13).
- Guido Da Vigevano (1335) *Le machine del re: Texaurus* (see G. Ostuni, 1993).
- Guido Ubaldo del Monte (1577). *Mechanicorum Liber*, Urbino.
- Hachette, Jean N.P. (1830) *Histoire des machine à vapeur*, Corby, Paris.
- Hachette, Jean N.P. (1811) *Traité Elementaire des Machines*, Paris.
- Hall, A.R. (1976a) Translation of Vigevano's *De Rebus Bellicis*.
- Hall, A.R. (1976b) Guido's *Texaurus 1335*, in *On Pre-Modern Technology and Science: A Volume in Honor of Lynn White, Jr.*, B.S. Hall and D.C. West (Eds.), Udena Publ., Malibu, CA, pp. 11–52.
- Hardenberg, H.H. (2000) *The Middle Ages of the Internal Combustion Engine 1794–1886*, Society of Automotive Engineers, Warrendale, PA.
- Hart, I.B. (1925) *The Mechanical Investigations of Leonardo da Vinci*, Chapman and Hall Ltd., London.
- Hart, I.B. (1961) *The World of Leonardo da Vinci*, The Viking Press, New York.
- Hartenberg, R.S. and Denavit, J. (1964) *Kinematic Synthesis of Linkages*, McGraw-Hill Book Co., New York, p. 75.
- Hartmann, W. (1913) *Die Maschinengetriebe*, Stuttgart.

- Haton de la Goupilliere, J.-N. (1864) *Traité des Mécanismes*, Gauthier-Villars, Paris.
- Henderson, D.W. and Taimina, D. (2004) *Experiencing Geometry: Euclidian and Non-Euclidian with History*, 3rd Edition, Pearson Prentice Hall, NJ, Chapter 21, 'Mechanisms'.
- Heron of Alexandria (also known as Hero) (1589) *De Gli Automati, ouero Machine Se Movemati, Libri due*, Translation into Italian by Bardardino Baldi, Editioni Ristampe anastatiche, Milan, 1962.
- Hilbert, D. and Cohn-Vossen, S. (1983) *Geometry and Imagination*, Chelsea Publ., New York, Chapter V, 'Kinematics'.
- Honnecourt, Villard de (see Villard de Honnecourt).
- Homer (750–700 B.C.) *The Odyssey* (Modern translation, E.V. Rieu and D.C.H. Rieu, Penguin Books, 1946, 2003).
- Huygens, C. (1673) *Horologium* (see also English translation of Richard J. Blackwell; Christiaan Huygens' *The Pendulum Clock or Geometrical Demonstrations Concerning the Motion of Pendula as Applied to Clocks*).
- IFTToMM (1990) Terminology for the Theory of Machines and Mechanisms, *Mechanism and Machine Theory* **26**(5).
- Johansson, G. (1973) Visual Perception of Biological Motion and a Model for Its Analysis, *Perception and Psychophysics*, **14**, 201–211.
- Johansson, G. (1975) Visual Motion and Perception, *Scientific American*, **232**, 76–88.
- Johnson, W.A. (Translator) (1963) *Christopher Polhem, The Father of Swedish Technology* (1911). Hartford, Connecticut.
- Jardine, L. (2004) *The Curious Life of Robert Hooke*, HarperCollins, New York.
- Jokish, D., and Troje, N.F. (2002) Biological Motion as a Cue for Perception of Size, *J. Vision* **3**(4), 2252–264.
- Jones, F.D. (1930–1951) *Ingenueous Mechanisms for Designers and Inventors*, 1st Edition, Industrial Press, New York, 3 Volumes, edited by H.L. Horton.
- Kasson, J.F. (1976) *Civilizing the Machine*, Penguin Books, Middlesex, England, Chapter 4, 'The Aesthetics of Machinery'.
- Keller, A.G. (1964) *A Theatre of Machines*, Chapman & Hall, London.
- Kennedy, A.B.W. (1881) *The Kinematics of Machinery: Two Lectures Relating to Reuleaux Methods*, Delivered at the South Kensington Museum with an Introduction by Professor RH Thurston, Reprinted from Van Nostrand's Magazine. D. Van Nostrand Publ., New York.
- Kennedy, A.B.W. (1886) *The Mechanics of Machinery*, MacMillan and Co., London
- Kennedy, A.B.W. (1876a) Book Review, *The Kinematics of Machinery; Outlines of a Theory of Machines*, F. Reuleaux, Translated by A.B.W. Kennedy, *Engineering* **22**, 197.
- Kennedy, A.B.W. (1876b) The Berlin Kinematic Models, *Engineering* **22**, 239–240.
- Kerle, M. and Helm, M. (2000) Animal Kinematics – A Review of a Study of Franz Reuleaux About Restained Animal Motions, in *International Symposium on History of Machines and Mechanisms, Proceedings HMM 2000*, M. Ceccarelli (Ed.), Kluwer Academic Publ., Dordrecht, pp. 181–186.
- King, R. (2000) *Brunelleschi's Dome*, Penguin Books, New York.
- KMODDL (2004) 'Kinematic Models for Design Digital Library', <http://kmoddl.library.cornell.edu>.
- Knight, E.H. (1874–1876) *Knight's American Mechanical Dictionary*, 3 Volumes, New York.
- Knobloch, E. (1984) Editor and Translator of Mariano Taccola (1449) *De Rebus Militaribus De Machinis*, Verlag Valentin Koerner, Baden-Baden.

- Koetsier, T. (2000) 'Mechanism and Machine Science: Its History and Its Identity', in, *International Symposium on History of Machines and Mechanisms, Proceedings HMM 2000*, M. Ceccarelli (Ed.), Kluwer Academic Publ., Dordrecht, pp. 5–24.
- Koetsier, T. (2001a) La theorie des machines au XVIe siecle: Tartaglia, Guidobaldi, Galileo, *Corpus, Revue de Philosophie* **39**, 155–189 (The Theory of Elementary Machines in the 2nd half of the 16th C.: Guido Ubaldo del Monte [1545–1607] and Galileo Galilei [1564–1642], Preprint WS-539, Vrije Universiteit, Amsterdam).
- Koetsier, T. (2001b) On the Prehistory of Programmable Machines: Musical Automata, Looms, Calculators, *Mechanism and Machine Theory* **36**, 589–603.
- Kyaser, Konrad (c. 1405) *Bellifortis* (Facsimile, Edited by the Georg-Agricola Gesellschaft zur Forderung der Geschichte der Naturwissenschaft und der Technik, 1967, VDI Verlag, Dusseldorf, Germany).
- Laboulaye, C. (1849, 1864) *Traite de Cinematique ou Theorie des Mechanismes*, Paris, 1849, 2nd edition 1864.
- Lagrange, J.L. (1788) *Traité de Mécanique Analytique*, Paris.
- Landels, J.G. (1978) *Engineering in the Ancient World, Ancient Culture and Society*, University of California Press, Berkeley, CA.
- Lanz, P.L. & Bétancourt, A. de (1808) *Essai sur la Composition des Machines*, Paris.
- Lanz, P.L. & Bétancourt, A. de (1808) *Analytical Essay on the Construction of Machines*, Paris, Translated from the French, R. Ackermann, London.
- Laurenza, D., *Leonardo's Machines, Da Vinci's Inventions Revealed* (see Taddei, 2006).
- Lefèvre, W. (Ed.) (2004) *Picturing Machines, 1400–1700*, MIT Press, Cambridge, MA.
- Leonardo da Vinci (c. 1500) *Le Manuscrit A–M*, Institut de France (Facsimile Edition: *Les manuscrits de Leonard de Vinci: le manuscrit A–[M] de la Bibliothèque de l'Institut [de France]*, Translation in French, by C. Ravaisson-Mollien, 1881–1901).
- Leonardo da Vinci (c. 1500) *Codex Atlanticus*, Milan (Facsimile Edition, *Il Codice Atlantico della Biblioteca Ambrosiana di Milano/Leonardo da Vinci*, Translation into Italian by A. Marinoni, Preface by C. Pedretti, 2000, Giunti, Firenze, 3 Vols.); (Facsimile Edition: published by Regis Accademia dei Lincei, 1894–1904).
- Leonardo da Vinci (c. 1500) *Codex Madrid or Tratado de Estatica y Mechanica en Italiano, 1493*, Madrid (Facsimile Edition: *The Madrid Codices, National Library Madrid, No. 8937*, Translated by Ladislao Reti, McGraw-Hill Book Co., 5 vols., 1974).
- Leonardo da Vinci (c. 1500) *Codex Leicester*, London (Facsimile Edition: *Leonardo da Vinci: The Codex Leicester – The Notebook of a Genius*, Powerhouse Publishing, Museum of Applied Arts and Sciences, Sydney Australia, 2000, Commentary, C. Pedretti).
- Leonardo da Vinci (c. 1500) *Treatise on Painting*, Translated by John Francis Rigaud, 1802, reprinted 1877 George Bell & Sons, London.
- Leonardo da Vinci (c. 1505) *Sul Volo degli Uccelli*, Treatise on the Flight of Birds (previously part of Manuscript B, Turin) (Facsimile Edition: *Der Vögel Flug – Sul volo degli Uccelli*, Edited and translated by M. Schneider, Schirmer/Mosel, München, 2000).
- Leonardo da Vinci (c. 1510) *Anatomia Fogli A and B*, Royal Library, Windsor.
- Leonardo da Vinci (c. 1510) *Quaderni d'Anatomia I–VI*, Royal Library, Windsor.
- Leupold, Jacob (1724) *Theatrum Machinarum Generale*, Leipzig.
- Libri, G. (1840) *Histoire des Sciences Mathématique en Italie*, J. Renouard, Paris.
- Lilienthal, O. (1889) *Der Vogelflug als Grundlage der Fliegekunst*, R. Gaertners Verlagbuchhandlung, Berlin.
- Lipson, H. (2005) Evolutionary Synthesis of Kinematic Mechanism, *J. Computer Aided Design* (to appear) (see also Zykov et al., 2005).

- Lipson, H. (2006) Evolutionary Robotics and Open-Ended Automation, in *Biomimetics*, Y. Bar-Cohen (Ed.), CRC Press, Boca Raton, FL, Chapter 4, pp. 129–155.
- Lipson, H., Moon, F.C., Hai, J. and Paventi, C. (2005) Three-Dimensional Printing the History of Mechanisms, *J. Mechanical Design* **127**.
- Listing, J.B. (1848) *Topology*, Göttingen.
- Long, P.O. (2004) Picturing the Machine: Francesco di Giorgio and Leonardo da Vinci, in *Picturing Machines, 1400–1700*, W. Lefèvre (Ed.), MIT Press, Cambridge, MA, pp. 117–141.
- MacCord, C.W. (1883) *Kinematics*, J. Wiley & Sons, New York.
- MacCurdy, E. (1906, 1938) *The Notebooks of Leonardo da Vinci*, Reynal & Hitchcock, NY.
- Mahoney, M.S. (2004) Drawing Mechanics, in *Picturing Machines, 1400–1700*, W. Lefèvre (Ed.), MIT Press, Cambridge, MA, pp. 281–306.
- Marey, E.J. (1873) *La Machine Animal: Locomotive terrestre et aeriennne*.
- Martin, E. (1992) *The Calculating Machines* (Die Rechenmaschinen), MIT Press.
- Masi, F. (1883) *Manuale di Cinematica Applicata; Nuova Classificazione Dei Meccanismi*, Nicola Zanichelli, Bologna.
- Masi, F. (1897) *La Teoria Dei Meccanismi*, Nicola Zanichelli, Bologna.
- Masters, R.D. (1999) *Fortune is a River*, Plume, Penguin Putnam, Inc., New York.
- Mauersberger, K. (1985) Suche nach dem Attribut der Technik; Zum Maschinenbaustil des 19 Jahrhunderts (On mechanical engineering style in the 19th century), *Form + Zweck, DDR* (Form and Function) **1**, 15–20.
- Mauersberger, K. (1988) Franz Reuleaux – Begründer der Kinematik, *Feingerätetechnik (Berlin)* **37**, 38–41.
- Mauersberger, K. (1989), The Development of German Engineering Education in the Nineteenth Century – A Comparison with Great Britain and France, in *European Historiography of Technology*, Dan. Ch. Christensen (Ed.).
- Mauersberger, K. (1994) Visuelles Denken und nichtverbales Wissen in Maschinenbau (Visual Thinking and Nonverbal Knowledge in Mechanical Engineering), *Beiträge zur Geschichte von Technik und Techniker Bildung*, Folge, Hochschule für Technik, Wirtschaft und Kultur, Leipzig (FH), 3–27.
- Mauersberger, K. (1997) Die Getriebemodellsammlung der Technischen Universität Dresden (The Mechanism Model Collection of the Technical University Dresden), *Wissenschaftliche Zeitschrift der Technischen Universität Dresden* **46**(3).
- Mauersberger, K. (2005) Franz Reuleaux and die Kinematic – Ein kühner heuristischer Entwurf der Maschinenwissenschaften im 19. Jahrhundert, in *Dahlemer Archivesprache*, Band II, Archiv zur Geschichte der Max-Planck-Gesellschaft, E. Henning and M. Kazemi (Eds.), Berlin, pp. 73–96.
- Maybie, H.H. and Ocvirk, F.W. (1966) *Mechanisms and Dynamics of Machinery*.
- Mayr, O. (1969, 1970) *The Origins of Feedback Control*, Translation of *Zur Frühgeschichte der technischen Regelungen*, MIT Press, Cambridge, MA.
- McGeer, T. (1990) Passive Dynamic Walking, *Intl. J. Robotics Res.* **9**(2) (April).
- Menschik, A. (1987) *Biometrie*, Springer Verlag, Berlin, Germany.
- Minkowski, H. (1911) Über die Körper konstanter Breite (Of Curves of Constant Breadth), *Gesammelte Abhandlungen*, Band II, Leipzig, S. 277–279, p. 67.
- Moll, C.L. and Reuleaux, F. (1854) *Constructionslehre für den Maschinenbau* (Design for Mechanical Engineering), Druck und Verlag von Friedrich Vieweg und Sohn, Braunschweig.
- Monge, G. (1795) *Géométrie Descriptive*, Paris.
- Moon, F.C. (1992) *Chaotic and Fractal Dynamics*, Wiley, New York.
- Moon, F.C. (2000) The Language of Invention, *The Bookpress* **10** (1).

- Moon, F.C. (2003a) Franz Reuleaux; Contributions to 19th Century Kinematics and History of Machines, *Applied Mechanics Reviews* **56**(2), 261–285.
- Moon, F.C. (2003b) Robert Willis and Franz Reuleaux: Pioneers in the Theory of Machines, *Notes and Records of the Royal Society* **57**(2), 209–230.
- Moon, F.C. (2004) The Reuleaux Models: Creating an International Digital Library of Kinematics History, in *International Symposium on History of Machines and Mechanisms, Proc. HMM2004*, M. Ceccarelli (Ed.), Kluwer Academic Publ., Dordrecht.
- Moon, F.C. (2005) The Kinematic Mechanisms of Francesco di Giorgio Martini and Franz Reuleaux, in *Proc. Workshop of Int. Federation for the Theory of Machines and Mechanisms; History of Machines and Mechanisms*, Bauman Moscow State Technical University, May.
- Moon, F.C., Lipson, H. and Kostka, T. (2007) Reverse Engineering and Physical Reconstruction of the 19th Century Arithmometer of Thomas de Colmar, Cornell University Report, Mechanical and Aerospace Engineering (submitted for publication).
- Moon, F.C. and Stiefel, P.D. (2006) Coexisting Chaotic and Periodic Dynamics in Clock Escapements, *Phil. Trans. R. Soc. A* **364** (July), 2539–2563.
- Mumford, L. (1934) *Technics and Civilization*, Harcourt, Brace and Co., New York.
- Muybridge, Eadweard, J. (1887) *Animal Locomotion*, Reprinted by Dover Publishing Co., New York.
- Muybridge, Eadweard, J. (1901) *The Human Figure in Motion*, Reprinted by Dover Publishing Co., New York.
- Needham, J. (1965) *Science and Civilization in China, Vol. 4, Physics and Physical Technology*, Part 3 Mechanical Engineering, Cambridge University Press, Cambridge, UK.
- Newton, Sir Isaac (1686) *Principia*, Translated by Motte (1729), Revised by Cajori (1962), University of California Press, Berkeley, CA.
- Nicholl, Charles (2004) *Leonardo da Vinci: Flights of the Mind*, Viking Penguin Group, New York.
- Nuland, S.B. (2000) *Leonardo da Vinci*, Viking Penguin, NY.
- O'Malley, C. and Saunders, J.B. De C.M. (1952) *Leonardo da Vinci on the Human Body*, Henry Schuman Publishers, New York.
- Ord-Hume, A.W.J.G. (1977) *Perpetual Motion*, St. Martins Press, New York.
- Ostuni, G. (1993) Editor and Translator of *Le Machine Del Re; Il "Texaurus Regis Francie" di Guido da Vigevano*, Societa Storica Vigevanese and Diakronia, Italy.
- Pacey, A. (1999) *Meaning in Technology*, MIT Press, Cambridge, MA.
- Pacioli, Fra Luca (1509) *De Divina Proportione* (Part I, p. 32, Part II, pp. 15, 48).
- Pappus of Alexandria [c. 284–305] *Mathematical Collection* (see Cuomo, 2000).
- Parks, T. (2005) *Medici Money, Banking, Metaphysics and Art in Fifteenth Century Florence*, WW Norton & Co., New York/London.
- Parsons, W.B. (1939, 1968) *Engineers and Engineering in the Renaissance*, 1st edition 1939, MIT Press, Cambridge, MA, 1968.
- Paul, B. (1979) *Kinematics and Dynamics of Planar Machinery*, Prentice Hall, NJ.
- Peaucellier, Charles-Nicholas (1864, 1873) Note sur une question de géométrie de compas, *Nouvelles Annales de Mathématiques, Ser. 2* **12**, 71–78.
- Pedretti, C. (1999, 2000) *Leonardo: The Machines*, Giunti, Florence.
- Phillips, J. (1990) *Freedom in Machinery, Screw Theory Exemplified*, Vols. I and 2, Cambridge University Press, Cambridge, UK.
- Piaget, J. (1969) *The Mechanisms of Perception*, Basic Books, Inc., New York.
- Poincaré, H. (1899) *Cinématique et Mécanismes*, G. Carré et C. Naud Éditeurs, Paris.

- Poinsot, M. (1834) *Outlines of A New Theory of Rotatory Motion*, Translation from the French by Charles Whitley, Cambridge.
- Polhem, Christopher, see William A. Johnson (1963).
- Ponting, K. (1979) *Leonardo da Vinci, Drawings of Textile Machines*, Moonraker Press, Wiltshire, England.
- Pontus Hultén, K.G. (1968) *“The Machine” as Seen at the End of the Mechanical Age*, The Museum of Modern Art, New York.
- Popp, K. and Stein, E. (2000) Ed. *Leibniz*, Univ. Hannover, Schlütersche GmbH Verlag, Hannover.
- Price, D.J. de Solla (1959) An Ancient Greek Computer, *Scientific American*, pp. 60–67.
- Rademacher, H. and Toeplitz, O. (1957) *The Enjoyment of Mathematics*, Princeton University Press, Princeton, NJ, pp. 163–177, 203.
- Raibert, M.H. (1986) *Legged Robots That Balance*, MIT Press, Cambridge, MA.
- Ramelli, Agostino (1588) *Livre des Diverse et Artificieuses Machine*, Paris (Reprinted by Dover Publishing Company, New York, Gnudi & Ferguson (Eds.), 1976, 1994).
- Rankine, W. (1887) *A Manual of Machinery and Millwork*, Edition 6, London.
- Rankine, W. (1868) *A Manual of Applied Mechanics*, Charles Griffin and Co., London.
- Read, A. and Fisher, D. (1994) *Berlin Rising: Biography of a City*, W.W. Norton, New York.
- Redtenbacher, F. (1861) *Resultate für den Maschinenbau*, Verlag von F. Bassermann, Mannheim, Germany.
- Redtenbacher, F. (1862–1865) *Der Maschinenbau*, 3 Volumes.
- Redtenbacher, F. (1857, 1866) *Die Bewegungs Mechanismen*. Verlagsbuchhandlung von F. Bassermann, Mannheim.
- Remberger, S. (1999) *Franz Reuleaux: Ansichten und Selbstverständnis eines Ingenieurs in der deutschen Gesellschaft des späten 19 Jahrhunderts*, Magisterarbeit, Ludwig-Maximilians-Universität, München.
- Remberger, S. (2000) Billig und schlecht – Franz Reuleaux zu den Weltausstellungen in Philadelphia und Chicago, *Kultur & Technik* 3 (July–September), 42–45.
- Reti, L. (1963) Francesco di Giorgio Martini’s Treatise on Engineering and Its Plagiarists, *Technology and Culture* IV(3) (Summer), 287–298.
- Reti, L. (1969) Leonardo The Technologist: The problem of Prime Movers, in *Leonardo’s Legacy*, C.D. O’Malley (Ed.), University of California Press, Berkeley, CA.
- Reti, L. (1972) Leonardo and Ramelli, *Technology and Culture* 13(4) (October), 577–605.
- Reti, L. (Ed.) (1974) *The Unknown Leonardo*, McGraw Hill, New York (see Chapter ‘The Engineer’, by L. Reti).
- Reti, L. (1980) The Engineer, in *Leonardo The Inventor*, L.H. Heydenrich, B. Dibner and L. Reti, McGraw-Hill, New York, pp. 124–185.
- Reuleaux, F. (1861) *Der Constructeur: Ein Handbuch zum Gebrauch beim Maschinen-Entwerfen*, Verlag von Friedrich Vieweg und Sohn, Braunschweig (1st Edition; in German).
- Reuleaux, F. (1862) *Die Thomasche Rechenmaschine Civilingenieur*, Band VIII, Heft 3.
- Reuleaux, F. (1875) *Theoretische Kinematik; Grundzüge einer Theorie des Maschinenwesens*, Verlag Vieweg & Sohn Braunschweig.
- Reuleaux, F. (1876a) *Kinematics of Machinery; Outlines of a Theory of Machines*, ABW Kennedy, Translation MacMillan and Co., London (Dover Edition).
- Reuleaux, F. (1876b) Das Zentrifugalmoment, Ein Beitrag zur Dynamik, *Verhandlungen des Verein zur Beforderung des Gewerbefleisses* 55 (Sitzungsberichte), 50–88.
- Reuleaux, F. (1877) *Briefe Aus Philadelphia*, Braunschweig.

- Reuleaux, F. (1884) *Eine Reise quer durch Indien im Jahre 1881; Erinnerungsblätter*, Allgemeine Verein für deutsche Literatur, Berlin.
- Reuleaux, F. (Ed.) (1884) *Buch der Erfindungen; Gewerbe und Industrien* (The Book of Inventions), Reprinted by Bechtermünz Verlag, 1998.
- Reuleaux, F. (1885) The Influence of the Technical Sciences upon General Culture, Translated from the German by W. Kunhardt, *School of Mines Quarterly* VII(1) (October) (Translation of *Cultur und Technik, ein Zeitschrift des Vereins deutscher Ingenieure*, 1885, S 24).
- Reuleaux, F. (1893) *The Constructor; A Handbook of Machine Design*, 4th Edition, H.H. Suplee, Translation, 1892, Philadelphia.
- Reuleaux, F. (1893) *Mitteilungen über die amerikanische Maschinen-Industrie*, Berlin.
- Reuleaux, F. (1900) *Lehrbuch der Kinematik; Zweiter Band. Die Praktischen Beziehungen Kinematik zu Geometrie und Mechanik*, Verlag von F. Vieweg und Sohn, Braunschweig.
- Rice, E.F. Jr. and Grafton, A. (1994) *The Foundations of Early Modern Europe, 1460–1559*, 2nd Edition, W.W. Norton & Co., New York.
- Rolt, L.T.C. (1970) *Victorian Engineering*, Penguin Books, New York.
- Rosheim, M.E. (1994) *Robot Evolution*, Wiley, New York.
- Rosheim, M.E. (2006) *Leonardo's Lost Robots*, Springer Verlag, Berlin.
- Roth, B. (2000) The Search for the Fundamental Principles of Mechanism Design, in *International Symposium on History of Machines and Mechanisms, Proceedings HMM 2000*, M. Ceccarelli (Ed.), Kluwer Academic Publ., Dordrecht, pp. 187–195.
- Ruina, A., Srinivasan, M. and Bertram, J. (2005) *J. of Theoretical Biology*.
- Sale, K. (1995) *Rebels against the Future, The Luddites and Their War on the Industrial Revolution, Lessons for the Computer Age*, Addison-Wesley, Reading, MA.
- Sand, George (1860) *The Black City*, Carroll & Graf Publishers, New York.
- Sangallo, Guiliano da [1445–1516] *Sketchbook* (Cited in Galluzzi).
- Sass, S.L. (1998) *The Substance of Civilization*, Arcade Pub. Co., New York.
- Scaglia, G. (1985) *Il Vitruvio Magliabechiano di Francesco di Giorgio Martini*, Gonnelli, Firenze.
- Scaglia, G. (1992) *Francesco di Giorgio: Checklist and History of Manuscripts and Drawings*, Lehigh University Press, Bethlehem, PA.
- Scaglia, G. (1984) Translation of Taccola, Mariano (1449) *De Ingeneis: Text and Facsimile*, Prager, U. Montag, Dr. Ludwig Reichert Verlag, Wiesbaden, Germany.
- Scherer, V. (1907) *The Work of Durer*, Brentano Press, New York.
- Schreck, J. (J. Terentino or Terentius) and Wang Chang (1627) *Qi Qi Tu Shou (Chhi Chhi Thu Shou*, pre PRC transliteration) *Diagrams and Explanations of Strange Machines*.
- Schröder, J. (1884) *Catalog of Kinematic Models*, Darmstadt, Germany.
- Schubert, Johann Andreas, see Mauersberger (1997).
- Scientific American*, October 17, 1885, Vol. LIII, No. 16 (New Series). (Cover shows cabinets with Reuleaux kinematic models and the footnote “Sibley College Museum of Mechanisms”.)
- Seiflow, G.H.F. (1999) *The Seiflow Archives*, web site with Reuleaux–Seiflow family tree, <http://freespace.virgin.net/patrick.seiflow/Archives.htm>.
- Severin, D. (2000) Franz Reuleaux, der Wissenschaftler und Ingenieur, *Von der Bauakademie zur Technischen Universität Berlin: Geschichte und Zukunft, 1799–1999*, Earnst & Son, Wiley, pp. 300–304.
- Shepherd, D. (1990) *Historical Development of the Windmill*, NASA Contractor Report 4337, DOE/NASA 5266-1.
- Shigley, J.E. (1963) *Mechanical Engineering Design*, McGraw-Hill.

- Shiroshita, S., Kumamoto, H., Nishihara, O. and Jing, D. (2001) Constructing a Virtual Museum of Machine Mechanism Models Imported from Germany During Japanese Westernization for Higher Education: 3D Animations Based on Kinematics and Dynamics, Presented at *Museums and the Web 2001*, <http://www.archimuse.com/mw2001/papers/Shiroshita.html>.
- Shulman, S. (2002) *Unlocking the Sky: Glenn Curtiss and the Race to Invent the Airplane*, HarperCollins Publ., New York.
- Singer, C., Holmyard, E.J., Hall, A.R. and Williams, T.L. (1956) *A History of Technology*, Oxford University Press, New York.
- Siemens, Werner von (1892) *Inventor and Entrepreneur: Recollections of Werner von Siemens* (Reprinted by Lund Humphries London, 1966, 1983).
- Smith, S. (1993), Drilling Square Holes, *Mathematics Teacher* **86** (October), 579–583.
- Snow, C.P. (1959, 1998) *The Two Cultures*, Cambridge University Press, Cambridge, UK.
- Sobel, D. (1995) *Longitude*, Walker Publ., New York.
- Standage, T. (2002) *The Turk*, Walker and Co., New York, pp. 128–137.
- Strada, Jacob de (1617–1618) *Künstlicher Abriss allerand Wasser-Wind, Ross-und-Handmühlen*, Frankfurt.
- Strandh, S. (1979, 1989) *The History of the Machine*, Dorset Press, New York.
- Strobino, Giovanni (1939) *Leonardo da Vinci e la Meccanica Tessile*, Milan, Italy.
- Suh, N.P. (1990) *The Principles of Design*, Oxford Press, New York.
- Suh, N.P. (2001) *Axiomatic Design*, Oxford Press, New York.
- Sussman, H.L. (1968) *Victorians and the Machine: The Literary Response to Technology*, Harvard University Press, Cambridge, MA.
- Sutera, Salvatore (1999) *Le fantastiche machine di Leonardo da Vinci*, Skira, Milan, Italy.
- Swade, D. (2000) *The Cogwheel Brain*, Abacus, Little Brown & Co London.
- The Sibley Journal of Engineering* **VIII**(9), June 1894, Cornell University.
- Taccola, Mariano (1449) *De Ingeenis: Text and Facsimile*, see G. Scaglia (1984).
- Taccola, Mariano (1449) *De Rebus Militaribus: De Machinis*, see Knobloch (1984).
- Taddei, M. and Zanon, E. (2006) Editors of text by Domenico Laurenzo, *Leonardo's Machines*, Guinti Industries, Florence, Italy.
- Tao, D.C. (1967) *Fundamentals of Applied Kinematics*, Addison-Wesley Publishing Company, Reading, MA.
- Thayer, W. (c.2005) On Vitruvius and His Machines, www.ukans.edu/history.
- Thilo, O. (1901) F. Reuleaux, Kinematik in Tierreiche, Sonderabdruck aus dem *Biologischen Centralblatt*, Band XXI Nr 16, 15. August, 514–528.
- Thurston, R.H. (1873) *Machinery and Manufacturers with an Account of European Manufacturing Districts*, Report on the Vienna Exhibition published by the US Department of State.
- Thurston, R.H. (1878, 1902) *History of the Growth of the Steam-Engine*, 4th Edition, D. Appleton and Co., New York.
- Thurston, R.H. (1894) *The Animal as Machine and a Prime Mover*, J. Wiley & Sons, New York.
- Toledano, R. (1987) *Francesco di Giorgio Martini, Pittore e scultore*, Electa Spa, Milan, Italy.
- Truesdell, C. (1968) *Essays in the History of Mechanics*, The Mechanics of Leonardo da Vinci, Part I, Springer-Verlag, New York, pp. 1–83.
- Turner, A.R. (1994) *Inventing Leonardo*, University of California Press, Berkeley, CA.
- Uccelli, A. (1940) *Leonardo da Vinci, I libri di meccanica, nella ricostruzione ordinata*, Hoepli, Milan, Italy.
- Uglow, J. (2002) *The Lunar Men*, Farrar, Straus and Giroux, NY.

- Usher, A.P. (1954, 1988) *A History of Inventions*, Revised Edition, Dover Pub. Co., New York, 1988.
- Valturio, Roberto (1472) *De Re Militari; Libris XII*, 1535 Edition Paris (on line at <http://kmoddl.library.cornell.edu>; click on References).
- Vasari, G. (1550) *Lives of the Most Eminent Painters, Sculptors and Architects*, Translated by G. DuC. Devere, Modern Library, 1959, Leonardo da Vinci, pp. 190–208.
- Venturi, G.B. (1797) *Essai sur les ouvages physico-mathématique de Leonardo da Vinci avec les fragments tires de ses manuscrits*, Vigevano, Guidodi (1335); *Textaurus*, Chez Duprat, Paris.
- Vesalius, Andreas (1543) *De humani corporis fabrica* (On the Structure of the Human Body).
- Villard de Honnecourt (c. 1225) *The Sketchbook of Villard Honnecourt*, T. White (Ed.), Indiana University Press, 1959.
- Vitruvius Pollio (27 CE) *The Ten Books on Architecture*, Translated by M.H. Morgan, Harvard University Press, Cambridge, MA, 1914.
- Vitruvius Pollio (c. 27 BCE) *The Architecture of Marcus Vitruvius Pollio in Ten Books*, Translated from the Latin by J. Gwilt, Edition of 1826, Priestley and Weale, London, Edition of 1874, Lockwood & Co. London, Book X, ‘On Machines and Engines’.
- Voigt, G. (188?) *Catalog of the Models of Franz Reuleaux*, Berlin, Germany.
- von Guericke, Otto (1672) *Experimenta Nova*, Amsterdam, Holland.
- Wang, Cheng (1637) *T'en-Kung K'ai-Wu* (see Schreck, J.).
- Wankel, F. (1963) *Einteilung der Rotations-Kolbenmaschinen*, Deutsche Verlags-Anstalt, Stuttgart (Published in English as *Rotary Piston Machines*).
- Weihe, C. (1942) *Franz Reuleaux und die Grundlagen seiner Kinematik*, Deutsches Museum, Abhandlungen und Berichte, VDI-Verlag GmbH, Berlin, 14. Jahrgang, Heft 4 (C. Weihe was Reuleaux's last student).
- Weisbach, J. (1848–1849) *Lehrbuch der Ingenieur- und Maschinen-Mechanik* (Principles of the Mechanics of Machinery and Engineering), W.R. Johnson (Ed.), Lea and Blanchard, Philadelphia, American Edition.
- Weller, A.S. (1943) *Francesco Di Giorgio 1439–1501*, The University of Chicago Press, Chicago, IL.
- Whelan, R. (1995) *Alfred Stieglitz, A Biography*, Little Brown and Co., Boston, MA, pp. 64–67.
- White, J. (1822) *A New Century of Inventions*, Manchester, England.
- Willis, R. (1841, 1870) *Principles of Mechanisms*, London, England.
- Willis, R. (1851) *A System of Apparatus for the Use of Lecturers and Experimenters in Mechanical Philosophy*.
- Willis, R. (1821) *An Attempt to Analyze the Automation Chess Player*, London, England.
- Willson, F.N. (1898) *Theoretical and Practical Graphics*, Part I, p. 52.
- Wittenburg, J. (1977) *Dynamics of Systems of Rigid Bodies*, BG Teubner, Stuttgart Germany.
- Wood, G. (2003) *Living Dolls*, Faber and Faber.
- Yaglom, I.M. and Boltyanskii, V.G. (1961) *Convex Figures*, Holt, Rinehart and Winston, New York, Chapters 7 and 8.
- Yan, H.S. (2005) A Systemic Approach for the Restoration of Lu-Ban's Wooden Horse Carriage of Ancient China, in *Workshop Proceedings, IFToMM History of Machines and Mechanisms*, Bauman Moscow State Technical University, Moscow, Russia.
- Yoshida, F. (1983) Robert Willis' Theory of Mechanism and Karl Marx, *Historia Scientiarum* 25 (September).
- Zeising, H. (1609, 1613) *Theatrum Machinarum*, Leipzig, Germany.
- Zonca, Vittorio (1607) *Novo teatro di machine et edificii per et secure operationi*, Padua, Italy.

- Zopke, H. (1896–1897) Professor Franz Reuleaux, A Biographical Sketch, *Cassiers Magazine*, New York.
- Zubov, V.P. (1968) *Leonardo da Vinci*, Harvard University Press, Cambridge, MA.
- Zykov, V., Mytilinaios, E., Adams, B. and Lipson, H. (2005) Self Reproducing Machines, *Nature* **435**(7038), 163–164 (see also Lipson, 2005).

Books on the Life of Leonardo da Vinci and as Machine Engineer

- Atalay, B. *Math and the Mona Lisa*.
- Beck, Th. (1899) *Beiträge zur Geschichte des Maschinenbaues*, Julius Springer, Berlin.
- Cianchi, M. (c. 1995) *Leonardo da Vinci's Machines*, Becocci Editore.
- Clark, K. (1939, 1959) *Leonardo da Vinci*, Revised Edition, Penguin Books, London.
- Cooper, M. *The Inventions of Leonardo da Vinci*, The Macmillan Co., New York.
- Crispino, E. (2000) *Leonardo: Art and Science*, Giunti, Firenze.
- Dibner, B. (1969), Leonardo: Prophet of Automation, in *Leonardo's Legacy*, C.D. O'Malley (Ed.), University of California Press, Berkeley, CA.
- Duhem, P. (1906–1913) *Etudes sur Leonard de Vinci*, 3 Vols., A. Hermann, Paris (Reprinted De Nobele, Paris, 1955).
- Feldhaus, F.M. (1922) *Leonardo, der Techniker und Erfinder*, E. Diederichs, Jena.
- Galluzzi, P. (Ed.) (1996) *Renaissance Engineers from Brunelleschi to Leonardo da Vinci*, Guinti Press, Florence.
- Galluzzi, P. (Ed.) (1997) *Mechanical Marvels: Invention in the Age of Leonardo*, Guinti Press, Florence.
- Gibbs-Smith, C.H. (1967) *Leonardo da Vinci's Aeronautics*, Science Museum, Her Majesty's Stationary Office, London.
- Gibbs-Smith, C. (1978) *The Inventions of Leonardo da Vinci*, Phaidon Press, Oxford.
- Gille, B. (1966) *The Renaissance Engineers*, Lund Humphries, London.
- Grothe, H. (1874) *Leonardo da Vinci als Ingenieur und Philosoph; Ein Beitrage zur Geschichte der Technik und der Inductiven Wissenschaften*, Nicolaische Verlag-Buchhandlung, Berlin.
- Hart, I.B. (1961) *The World of Leonardo da Vinci*, The Viking Press, New York.
- Heydenreich, L.H., Dibner, B. and Reti, L. (1980) *Leonardo the Inventor*, McGraw-Hill, New York.
- Kemp, M. (2004) *Leonardo*, Oxford University Press, Oxford.
- MacCurdy, E. (1906, 1938) *The Notebooks of Leonardo da Vinci*, Reynal & Hitchcock, New York.
- Masters, R.D. (1998) *Fortune Is a River: Leonardo da Vinci and Niccolo Machiavelli's Magnificent Dream to Change the Course of Florentine History*, Plume, Penguin, New York.
- Museo Nazionale della Scienza e della Tecnica Leonardo da Vinci (1998) *Le fantastiche macchine di Leonardo da Vinci: Come costruirle come farle funzionare*, Skira, Milano.
- Nicholl, C. (2004) *Leonardo da Vinci: Flights of the Mind*, Viking Penguin Group, New York.
- Nuland, S.B. (2000) *Leonardo da Vinci*, Penguin, New York.
- Parsons, W.B. (1939, 1968) *Engineers and Engineering in the Renaissance*, 1st edition 1939, MIT Press, Cambridge, MA, 1968.
- Pedretti, C. (1999, 2000) *Leonardo: The Machines*, Giunti, Firenze.
- Ponting, K.G. (1979) *Leonardo da Vinci: Drawings of Textile Machines*, Humanities Press Inc., NJ.

- Reti, L. (Ed.) (1974) *The Unknown Leonardo*, McGraw Hill, see Chapter 'The Engineer', by L. Reti.
- Reti, L. (1980) The Engineer, in *Leonardo The Inventor*, L.H. Heydenrich, B. Dibner, and L. Reti, McGraw-Hill, New York, pp. 124–185.
- Reti, L. (1969) Leonardo The Technologist: The problem of Prime Movers, in *Leonardo's Legacy*, C.D. O'Malley (Ed.), University of California Press, Berkeley, CA.
- Rosheim, A.E. (2006) *Leonardo's Lost Robots*, Springer Verlag, Berlin.
- Schneider, M. (2000) Editor and translator *Leonardo da Vinci: Der Vögel Flug – Sul volo degli uccelli*, Schirmer/Mosel, München [in Italian and German].
- Simone Cremante, Catalogo (2005) *Leonardo da Vinci: Genius of the Machines*, Introduction, M. Lombardi, Presentation, C. Pedretti, Cartei & Becagli, Firenze.
- Taddei, M. and Zanon, E. (2006) Editors of text by Domenico Laurenzo, *Leonardo's Machines, D & C*, Guinti Industries, Florence, Italy.
- Truesdell, C. (1968) *Essays in the History of Mechanics*, Springer-Verlag, New York.
- Turner, A.R. (1994) *Inventing Leonardo*, University of California Press, Berkeley, CA.
- Vasari, G. (1550) *Lives of the Most Eminent Painters, Sculptors and Architects*, Translated by G. DuC. Devere, Modern Library, 1959, Leonardo da Vinci, pp. 190–208.
- Venturi, G.-B. (1797) *Essai sur les ouvages physico-mathématique de Leonardo da Vinci avec les fragments tires de ses manuscrits*, Chez Duprat, Paris
- Zubov, V.P. (1968) *Leonardo da Vinci*, Harvard University Press, Cambridge, M.

Books on the History of Machines in the Industrial Age

- Ampere, A.-M. (1838) *Essai sur la Philosophie des Sciences*, Paris.
- Bassala, G. (1988) *The Evolution of Technology*, Cambridge University Press.
- Calvert, M. (1967) *History of Mechanical Engineering*, J. Hopkins Press.
- Daumas, M. (1962, 1969) *A History of Technology and Invention: Progress Through the Ages*, Vols, 1 and 2, Crown Publishers, New York (Translated from the French).
- Eco, U. and Zorzoli, G.B. (1963) *The Picture History of Inventions*, MacMillan Co., New York.
- Farey, J. (1827) *Treatise on the Steam Engine*.
- Gillispie, C.C. (1971) *Lazare Carnot Savant*, Princeton University Press, Chapter II 'The Science of Machines', pp. 31–61.
- Hardenberg, H.H. (2000) *The Middle Ages of the Internal Combustion Engine 1794–1886*, Society of Automotive Engineers, Warrendale, PA.
- Hindle, B. and Lubar, S. (1986) *Engines of Change: The American Industrial Revolution 1790–1860*, Smithsonian Institution Press, Washington, DC.
- Kennedy, A.B.W. (1876b) The Berlin Kinematic Models, *Engineering* **22**, 239–240.
- Mauersberger, K (1989) The Development of German Engineering Education in the Nineteenth Century – A Comparison with Great Britain and France, *European Historiography of Technology*, Dan. Ch. Christensen (Ed.).
- Moon, F.C. (2003) Robert Willis and Franz Reuleaux: Pioneers in the Theory of Machines, *Notes and Records of the Royal Society*, London.
- Pacey, Arnold (1990) *Technology in World Civilization*, MIT Press, Cambridge, MA.
- Pontus Hultén, K.G. (1968) "The Machine" As Seen at the End of the Mechanical Age, The Museum of Modern Art, New York.

- Reuleaux, F. (Ed.) (1884) *Buch der Erfindungen; Gewerbe und Industrien* (The Book of Inventions), Reprinted by Bechtermünz Verlag, 1998.
- Reuleaux, F. (1885) The Influence of the Technical Sciences upon General Culture, Translated from the German by W. Kunhardt, *School of Mines Quarterly* VII(1) (October) (Translation of *Cultur und Technik, ein Zeitschrift des Vereins deutscher Ingenieure*, 1885, S 24).
- Rolt, L.T.C. (1970) *Victorian Engineering*, Penguin Books, New York.
- Singer, C, Holmyard, E.J., Hall, A.R. and Williams, T.L. (1956) *A History of Technology*, Oxford University Press, New York.
- Siemens, Werner von (1892) *Inventor and Entrepreneur: Recollections of Werner von Siemens*, Reprinted by Lund Humphries London, 1966, 1983.
- Strandh, S. (1979, 1989) *The History of the Machine*, Dorset Press, New York.
- Sussman, H.L. (1968) *Victorians and the Machine: The Literary Response to Technology*, Harvard University Press, Cambridge MA.
- Swade, D. (2000) *The Cogwheel Brain*, Abacus, Little Brown & Co., London.
- Thurston, R.H. (1878, 1902) *History of the Growth of the Steam-Engine*, 4th Edition, D. Appleton and Co., New York.
- Usher, A.P. (1954, 1988) *A History of Inventions*, Revised Edition, Dover Publ., New York, 1988.
- Wankel, F. (1963) *Einteilung der Rotations-Kolbenmaschinen*, Deutsche Verlags-Anstalt, Stuttgart (Published in English as *Rotary Piston Machines*).

Books on the History of the Renaissance in Europe

- Burckhardt, J. (1860) *Die Kultur der Renaissance in Italien* (The Civilization of the Renaissance in Italy), 2002 Edition, Modern Library, Random House, New York.
- Feldhaus, Franz M. (1954) *Die Maschine im Leben der Völker: Ein Überblick von der Urzeit bis zur Renaissance*, Birkhäuser, Basel.
- Gille, B. (1966) *The Renaissance Engineers*, Lund Humphries, London
- Grafton, A. (2000) *Leon Battista Alberti: Master Builder of the Italian Renaissance*, Harvard University Press, Cambridge.
- King, R. (2000) *Brunelleschi's Dome*, Penguin Books, New York.
- Parsons, W.B. (1939, 1968) *Engineers and Engineering in the Renaissance*, 1st edition 1939, MIT Press, Cambridge, MA, 1968.
- Rice, E.F. Jr. and Grafton, A. (1994) *The Foundations of Early Modern Europe, 1460–1559*, 2nd Edition, W.W. Norton & Co., New York.
- Vasari, G. (1550) *Lives of the Most Eminent Painters, Sculptors and Architects*, Translated by G. DuC. Devere, Modern Library, 1959, Leonardo da Vinci, pp. 190–208.

Books and Articles on Franz Reuleaux and the Kinematic Theory of Machines

- Ampere, A.-M. (1838) *Essai sur la Philosophie des Sciences*.
- Babbage, C. (1826) On a Method of Expressing by Signs The Action of Machinery, *Phil. Trans. Royal Soc.* **116**, 250–265 (in *The Works of Charles Babbage*, M. Campbell-Kelly (Ed.), Vol. 3, William Pickering, London, 1989).

- Borgnis, J.A. (1818) *Traite Complet De Mechanique Applique aux Arts: Composition des Machines*, Bachelier, Librairie, Quai des Augustins, Paris.
- Braun, H.J. (1990) Franz Reuleaux, in *Berlinische Lebensbilder*, Band 6 Techniker, W. Treue and W. König (Eds.), Colloquium Verlag, Berlin, pp. 279–292.
- Braun, H.J. and Weber, W. (1979) Ingenieurwissenschaft und Gesellschaftspolitik: Das Wirken von Franz Reuleaux (Engineering Science and Corporate Politics: The Work of Franz Reuleaux), *Technik und Gesellschaft* **1**, 285–300.
- Burmester, L. (1888) *Lehrbuch der Kinematik*, Leipzig.
- Dimarogonas, A.D. (1993), *The Origins of the Theory of Machines and Mechanisms*, in *Modern Kinematics*, A.G. Erdman (Ed.), J. Wiley & Sons, New York, Section 1.2.
- Ferguson, E.S. (1962) Kinematics of Mechanisms from the Time of Watt, *United States National Museum Bulletin* **228**, Paper 27, 185–230.
- Gradenwitz, A. (1908) The Mutual Relations of Geometry and Mechanics and Prof Reuleaux's Mechanical Movements, *Scientific American*, March 21, 204–205.
- Grübler, M. (1917) *Getriebelehre*, Verlag von Julius Springer, Berlin.
- Hachette, Jean N.P. (1811) *Traité Elementaire des Machines*, Paris.
- Hartenberg, R.S. and Denavit, J. (1964) *Kinematic Synthesis of Linkages*, McGraw-Hill Book Co., New York, p. 75.
- Kennedy, A.B.W. (1881) *The Kinematics of Machinery: Two Lectures Relating to Reuleaux Methods*, Delivered at the South Kensington Museum with an Introduction by Professor R.H. Thurston, Reprinted from Van Nostrand's Magazine. D. Van Nostrand Publisher, New York.
- Kennedy, A.B.W. (1886) *The Mechanics of Machinery*, MacMillan and Co., London.
- Kennedy, A.B.W. (1876a) Book Review *The Kinematics of Machinery; Outlines of a Theory of Machines*, F. Reuleaux, Translated by A.B.W. Kennedy, *Engineering* **22**, 197.
- Kennedy, A.B.W. (1876b), The Berlin Kinematic Models, *Engineering* **22**, 239–240.
- Kerle, M. and Helm, M. (2000) Animal Kinematics – A Review of a Study of Franz Reuleaux About Restained Animal Motions, in *International Symposium on History of Machines and Mechanisms, Proceedings HMM 2000*, M. Ceccarelli (Ed.), Kluwer Academic Publ., Dordrecht, pp. 181–186.
- Laboulaye, C. (1849, 1864) *Traite de Cinematique ou Theorie des Mechanismes*, Paris, 1849, 2nd edition 1864.
- MacCord, C.W. (1883) *Kinematics*, J. Wiley & Sons, New York.
- Mauersberger, K. (1988) Franz Reuleaux – Begründer der Kinematik, *Feingerätetechnik* **37**, 38–41.
- Moll, C.L. and Reuleaux, F. (1854) *Constructionslehre für den Maschinenbau* (Design for Mechanical Engineering), Druck und Verlag von Friedrich Vieweg und Sohn, Braunschweig.
- Moon, F.C. (2000) The Language of Invention, *The Bookpress* **10**(1).
- Moon, F.C. (2003a) Franz Reuleaux; Contributions to 19th Century Kinematics and History of Machines, *Applied Mechanics Reviews* **56**(2), 261–0285.
- Moon, F.C. (2003b) Robert Willis and Franz Reuleaux: Pioneers in the Theory of Machines, *Notes and Records of the Royal Society* **57**(2), 209–230.
- Redtenbacher, F. (1861) *Resultate für den Maschinenbau*, Verlag von F. Bassermann, Mannheim.
- Remberger, S. (1999) *Franz Reuleaux: Ansichten und Selbsterkenntnis eines Ingenieurs in der deutschen Gesellschaft des späten 19. Jahrhunderts*, Magisterarbeit, Ludwig-Maximilians-Universität, München.
- Remberger, S. (2000) Billig und schlecht – Franz Reuleaux zu den Weltausstellungen in Philadelphia und Chicago, *Kultur & Technik* **3** (July–September), 42–45.

- Reuleaux, F. (1875) *Theoretische Kinematik; Grundzüge einer Theorie des Maschinenwesens*, Verlag Vieweg & Sohn Braunschweig.
- Reuleaux, F. (1876) *Kinematics of Machinery; Outlines of a Theory of Machines*, Translated by A.B.W. Kennedy, MacMillan and Co., London.
- Reuleaux, F. (1893) *The Constructor; A Handbook of Machine Design*, 4th Edition, Translated by H.H. Suplee, Philadelphia, 1892.
- Reuleaux, F. (1900) *Lehrbuch der Kinematik; Zweiter Band. Die Praktischen Beziehungen Kinematik zu Geometrie und Mechanik*, Verlag von F. Vieweg und Sohn, Braunschweig.
- Severin, D. (2000) Franz Reuleaux, der Wissenschaftler und Ingenieur, *Von der Bauakademie zur Technischen Universität Berlin: Geschichte und Zukunft, 1799–1999*, Earnst & Son (Wiley), pp. 300–304.
- Shiroshita, S., Kumamoto, H., Nishihara, O. and Jing, D. (2001) Constructing a Virtual Museum of Machine Mechanism Models Imported from Germany During Japanese Westernization for Higher Education: 3D Animations Based on Kinematics and Dynamics, Presented at *Museums and the Web 2001*, <http://www.archimuse.com/mw2001/papers/Shiroshita.html>.
- Thilo, O. (1901) F. Reuleaux, Kinematik in Tierreiche, *Sonderabdruck aus dem Biologischen Centralblatt*, Band XXI Nr. 16, 15. August, pp. 514–528.
- Voigt, G. (1907) *Catalog of the Models of Franz Reuleaux*, Berlin.
- Weihe, C. (1942) *Franz Reuleaux und die Grundlagen seiner Kinematik*, Deutsches Museum, Abhandlungen und Berichte, VDI-Verlag GmbH, Berlin, 14 Jahrgang, Heft 4 (C. Weihe was Reuleaux's last student).
- Willis, R. (1841, 1870) *Principles of Mechanisms*, London.
- Zopke, H. (1896–1897) Professor Franz Reuleaux, A Biographical Sketch, *Cassiers Magazine*, New York.

Books and Articles on Kinematics of Human and Animal Motion

- Alberti, Leon Battista (1452, 1485) *De re artificatore* (On the Art of Building).
- Atalay, B. (2004) *Math and the Mona Lisa*, Smithsonian Books, Washington.
- Bezerra, C.A.D. and Zampieri, D.E. (2004) Biped Robots: The State of the Art, in *International Symposium on History of Machines and Mechanisms, Proceedings, HMM 2004*, M. Ceccarelli (Ed.), Kluwer Academic Publ., Dordrecht.
- Borelli, G.A. (1680) *De Moto Animalium*, Rome.
- Borgnis, J.-A. (1818) *Traite Complet De Mecanique; Appliquee Aux Arts, Composition des Machines*, Bachelier Libraire, Paris.
- Egorova, Olga (2005) The Evolution History of Biomechanics as a Branch of Machine and Mechanism Science, in *Workshop Proceedings History of Machines and Mechanisms*, Bauman Moscow State Technical University, Moscow, Russia.
- Galluzzi, P. (1996) *Mechanical Marvels: Invention in the Age of Leonardo*, Giunti.
- Grafton, A. (2000) *Leon Battista Alberti; Master Builder of The Italian Renaissance*, Harvard University Press, Cambridge, MA.
- Kerle, Hanfried and Helm, Manfred (2000) Animal Kinematics: A Review of a Study of Franz Reuleaux about Restrained Animal Motions, *Conference of History of Machines and Mechanisms*, Int. Federation for the Theory of Machines and Mechanisms.
- Leonardo da Vinci (c. 1500) *Treatise on Painting*, Translated by John Francis Rigaud, 1802, Reprinted by George Bell & Sons, London, 1877.

- Leonardo da Vinci (c. 1510) *Anatomia Fogli A and B*, Royal Library, Windsor.
- Leonardo da Vinci (c. 1510) *Quaderni d'Anatomia I–VI*, Royal Library, Windsor.
- Marey, Etienne-Jules (1873) *La Machine Animal: Locomotive terrestre et aerienne*.
- McGeer, T. (1990) Passive Dynamic Walking, *The Intl. J Robotics Res.* 9(2) (April).
- MacCurdy, E. (1906, 1938) *The Notebooks of Leonardo da Vinci*, Vols. I, II, Reynal & Hitchcock, New York.
- Menschik, A. (1987) *Biometrie: Die Konstruktionsprinzip des Kniegelenks, des Hüftgelenks, der Beinlänge und der Körpergrösse*, Springer-Verlag, Berlin.
- Muybridge, Eadweard (1887) *Animal Locomotion*.
- Muybridge, Eadweard (1901) *The Human Figure in Motion*, Reprinted by Dover Publ.
- Nuland, S. B. (2000) *Leonardo da Vinci*, Viking Penguin, New York.
- O'Malley, C. and Saunders, J.B. de C.M. (1952) *Leonardo da Vinci on the Human Body*, Henry Schuman Publ., New York.
- Raibert, M.H. (1986) *Legged Robots That Balance*, MIT Press, Cambridge, MA.
- Redtenbacher, Ferdinand (1862) *Der Maschinenbau*, Erster Band, Freidrich Bassermann, Mannheim.
- Reuleaux, Franz (1900) *Lehrbuch der Kinematik; Zweiter Band, Die Praktischen Beziehungen Kinematik zu Geometrie und Mechanik*, Verlag von F. Vieweg und Sohn, Braunschweig.
- Rosheim, M.E. (1994) *Robot Evolution: The Development of Anthrobotics*, J. Wiley, New York.
- Ruina, A. et al. (2000) Passive Walking Machines, Cornell University Report.
- Taccola, Mariano (c. 1450) *De Ingeniis*.
- Thilo, O. (1901) F. Reuleaux, Kinematik im Tierreiche, Sonderabdruck aus dem *Biologischen Centralblatt* XXI(16), 15 August, 514–528.
- Thurston, R.H. (1894) *The Animal as a Machine and a Prime Motor and the law of Energetics*, John Wiley & Sons, New York.
- Vasari, Giorgio (1550, 1568) *Lives of the Most Eminent Painters Sculptors and Architects*.
- Versalius, Andreas (1543) *De humani corporis fabrica* (On the Structure of the Human Body).
- Willis, Robert (1841, 1870) *Principles of Mechanism*, London.
- Wood, G. (2002) *Edison's Eve: A Magical History of the Quest for Mechanical Life*, Knopf, Random House, New York.
- Wood, G. (2003) *Living Dolls*, Faber and Faber.
- Yan, Hong-Sen (2005) A Systematic Approach for the Restoration of Lu-Ban's Wooden Horse Carriage of Ancient China, in *Workshop Proceedings IFToMM History of Machines and Mechanisms*, Bauman Moscow State Technical University, Moscow, Russia.

History of Machines-related Books for a Teaching, Design Studio Library

[These books are available in affordable facsimile editions or from antiquarian book dealers, e.g. ABEBOOKS.com. They were chosen mainly for visual and graphic content related to machines and mechanisms.]

- Agricola, G. (1556) *De Re Metallica*, Transl. H.C. Hoover and L.H. Hoover in 1912, Dover Publ. Inc., New York, 1950.
- Al-Jazari, Ibn al-Razzaz (1204–1206) *The Book of Knowledge of Ingenious Mechanical Devices*, Translated and Annotated by Donald R. Hill, D. Reidel Publ. Co., Boston, MA.

- Artobolevsky, I.I. (1975, 1979) *Mechanisms in Modern Engineering Design*, 5 Vols. (2288 mechanisms), Mir Publishers, Moscow.
- Brown, H.T. (Ed.) (1868) *Five Hundred and Seven Mechanical Movements*, Brown, Coombs & Co, New York (models based on this catalog by Clark [c. 1930] in the Boston Museum of Science, may be seen on the KMODDL website).
- Cianchi, M. (c. 1995) *Leonardo's Machines*, Becocci Editore, Florence.
- Clark, W.M. (1943) *A Manual of Mechanical Movements*, Garden City Publishing Co, Garden City, New York (see also the KMODDL website, Boston Museum of Science models).
- Daumas, M. (1962, 1969) *A History of Technology and Invention: Progress Through the Ages*, Vols. 1 and 2, Crown Publishers, New York (Translated from the French).
- Drachmann, A.G. (1963) *The Mechanical Technology of Greek and Roman Antiquity*, Munksgaard, Copenhagen.
- Dudley, D.W. (1969) *The Evolution of Gear Art*, American Gear Manufacturers Assoc., Washington, DC.
- Dugas, R. (1955, 1988) *A History of Mechanics*, Dover Publications, New York.
- Eco, U. and Zorzoli, B.G. (1963) *The Picture History of Inventions*, MacMillan Co., New York.
- Erdman, A.G. and Sandor, G.N. (1997) *Mechanism Design: Analysis and Synthesis*, Third Edition, Prentice Hall, Upper Saddle River, NJ.
- Evans, Oliver (1805) *The Abortion of the Young Steam Engineer's Guide*, Reprinted by The Oliver Evans Press (1990). (Despite the strange title, this is one of the early practical texts on the steam engine.)
- Ferguson, E.S. (1962) Kinematics of Mechanisms from the Time of Watt, *United States National Museum Bulletin* **228**, Paper 27, 185–230.
- Ferguson, E.S. (1992) *Engineering and the Mind's Eye*, MIT Press, Cambridge, MA.
- Gibbs-Smith, C.H. (1978) *The Inventions of Leonardo da Vinci*, Phaidon Press, Oxford.
- Gille, B. (1966) *The Renaissance Engineers*, Lund Humphries, London. (This book provides a good balanced picture of other engineers of the Renaissance besides Leonardo.)
- Gimpel, J. (1976) *The Medieval Machine, The Industrial Revolution of the Middle Ages*, Holt, Rinehart, Winston, New York.
- Hardenberg, H.H. (2000) *The Middle Ages of the Internal Combustion Engine 1794–1886*, Society of Automotive Engineers, Warrendale, PA. (This book has a fascinating story of Reuleaux's role in the Otto-Langen Engine of 1867.)
- Hart, I.B. (1961) *The World of Leonardo da Vinci*, The Viking Press, New York. (One of the first English language books on Leonardo as a scientist and engineer.)
- Hartenberg, R.S. and Denavit, J. (1964) *Kinematic Synthesis of Linkages*, McGraw-Hill Book Co., New York, p. 75.
- Jones, F.D. (1930–1951) *Ingenuous Mechanisms for Designers and Inventors*, 1st Edition, Industrial Press, New York, 3 Volumes, H.L. Horton (Ed.).
- KMODDL, (2004) Kinematic Models for Design Digital Library, <http://kmoddl.library.cornell.edu>. (This website has over 400 kinematic models of Reuleaux, Redtenbacher and others, many with movies of the mechanisms in motion.)
- Knight, E.H. (1874–1876) *Knight's American Mechanical Dictionary*, 3 Volumes, New York.
- Leonardo da Vinci (c. 1500, 2000) *Codex Atlanticus*, Milan (Modern facsimile available in condensed format of 3 volumes, by Giunti, Florence).
- Mayr, O. (1969, 1970) *The Origins of Feedback Control* (Translation of *Zur Frühgeschichte der technischen Regelungen*), MIT Press, Cambridge, MA.
- Parsons, W.B. (1939, 1968) *Engineers and Engineering in the Renaissance*, 1st edition 1939, MIT Press, Cambridge, MA, 1968.

- Pedretti, C. (1999, 2000) *Leonardo: The Machines*, Giunti, Florence.
- Ramelli, Agostino (1588) *Livre des Diverse et Artificiose Machine*, Paris (Reprinted as *The Various and Ingenious Machines of Agostino Ramelli*, by Dover Publishing Company, New York. Gnudi & Ferguson, Eds.)
- Reti, L. (Ed.) (1974) *The Unknown Leonardo*, McGraw Hill, New York (see Chapter 'The Engineer' by L. Reti)
- Reuleaux, F. (1876) *Kinematics of Machinery; Outlines of a Theory of Machines*, Translated by A.B.W. Kennedy, MacMillan and Co., London (Reprinted by Dover Publ., New York).
- Reuleaux, F. (1893) *The Constructor; A Handbook of Machine Design*, 4th Edition, Translated by H.H. Suplee, Philadelphia, 1892. (This book has over 1200 illustrations.)
- Rosheim, M.E. (1994) *Robot Evolution*, Wiley, New York. (Many photos and drawings of robot components.)
- Rosheim, M.E. (2006) *Leonardo's Lost Robots*, Springer Verlag, Berlin.
- Singer C, Holmyard, E.J., Hall, A.R. and Williams, T.L. (1956) *A History of Technology*, Oxford University Press, New York.
- Strandh, S. (1979, 1989) *The History of the Machine*, Dorset Press, New York. (This book has lots of wonderful graphics of ancient and historic machines.)
- Sutera, Salvatore (1999) *Le fantastiche machine di Leonardo da Vinci*, Skira, Milan, Italy
- Taddei, M. and E. Zanon, (2006) Editors of text by Domenico Lorenzo, *Leonardo's Machines, D & C*, Guinti Industries, Florence, Italy. (Comes in a DVD format showing CAD drawings of the machines.)
- Usher, A.P. (1954, 1988) *A History of Inventions*, Revised Edition, Dover Pub. Co., New York, 1988.
- Wankel F (1963), *Einteilung der Rotations-Kolbenmaschinen*, Deutsche Verlags-Anstalt, Stuttgart (Published in English as *Rotary Piston Machines*).

APPENDIX I: A SUMMARY OF 'THEATRE OF MACHINES' BOOKS 15th–18th CENTURIES

Vitruvius Pollio, *De architectura* (c. 27 BCE)

Marcus Vitruvius Pollio was a Roman architect and engineer who likely worked during the reign of Julius Caesar and Augustus the first. The work consists of 10 books, most related to architecture, Roman construction methods, methods to find water, astronomy and finally the study of machines. Although there is some discussion of water clocks at the end of Book IX, our focus will be on Book X, which deals with machines. The extant versions of Vitruvius' work did not have any pictures of machines. However his work was passed down through the Middle Ages and many editions in several languages added sketches of what each translator understood to be the machines described by Vitruvius.

Following the Greek tradition, Vitruvius defined a machine in terms of forces rather than in terms of motions. “*A machine is a combination of timber fastened together chiefly efficacious in moving great weights*” (Book X, §i). He also distinguished between what is now called prime movers or ‘engines’ (‘organon’, in the Greek) and ‘machines’ (‘mechani’ in the Greek) or devices that are moved by prime movers. He stated that machines are inspired by the motions of planets and stars and discussed the lever and the circle as basic machine elements. Book X is divided into 16 sections which cover specific machine applications; §X.ii, Hoisting machines, §X.iv, Engines for raising water, §X.v, Water wheels and mills, §X.vi, The water screw, §X.x, Catapults, §X.xiii, Siege machines. Vitruvius’ program of describing machines by applications such as construction machines, production machines (e.g. mills), and military machines continued into the 17th century as we shall see in later machine books.

Amongst the applications described during Roman times are wine and oil presses, carts, carriages and wagons, mills, blacksmith bellows and turning lathes. In describing a machine for a mill, Vitruvius mentioned “*a drum with teeth is fixed into an end of the axle*” that appears to be a toothed wheel or ancient form of gear. In section X.vii, Vitruvius described the Pump of Ctesibius as a pair of bronze cylinders and valves with pistons rubbed with oil. Later translators drew a pair of cylinders on each side of a lever balance, moved in alternating motion by humans, animals or a water mill. This design propagated through the centuries until Newcomen’s double piston steam engine on a *balancier* arm, of 1732, with one of the pump cylinders replaced by a piston driven by steam generated vacuum.

Vitruvius also described a ‘hodometer’, a device to measure the distance traveled. A similar device was also attributed to Leonardo da Vinci, 15 centuries later.

Ibn al-Razzāz al-Jazari, *The Book of Knowledge of Ingenious Mechanical Devices* (1204–1206)

Little is known of this 13th century author of this text written in Arabic of which there are several copies in Oxford, Leiden and Dublin. The Arabs played a crucial role in the transmission of mathematical and technical knowledge both as a conveyer of ancient Greek and Asian knowledge and as a creator of new ideas and devices. Al-Jazari apparently worked for a ruler under the hegemony of Saladin. The *Book of Knowledge* is largely about hydraulic devices and machines for water clocks, fountains, pumps and related applications. There are many illustrations that show gear trains and water escapements for alternating fountains. The escapements are fairly sophisticated since they are inherently dynamic devices that require some understanding of the laws of physics whereas kinematic mechanisms rely generally on an understanding of geometry. The English-speaking student of technical history is fortunate to have the 1974 translation of Donald Hill, a scholar of Arabic and also an engineer. He has taken many of the drawings of al-Jazari, which are more like flat cartoons, and rendered them in isometric machine drawings.

Villard de Honnecourt, *Album de Villard de Honnecourt (The Sketchbook)* (c. 1225–1250)

This work can hardly be called a book of machines since it consists mainly of drawings of people, animals and architectural objects. Of the 65 plates, only 3–4 depict machines. The importance of the *Sketchbook* is as a marker in the history of machines since it includes a few devices that repeatedly appear in machine books centuries later. For example, on Plate 59, there is a cartoon sketch of a log-cutting machine used to produce planking. The machine appears to have gearing as well as a wheel type ratchet to advance the log into the saw blade. Similar machines are found in Francesco di Giorgio, Leonardo da Vinci and Besson (see below). There is also a catapult and a rendering of the famous *perpetual mobili* or perpetual motion wheel of broken pendulums that is also found in Leonardo and later technical illustrators. (An English translation can be found in an edited work by T. Bowie, 1960.)

Guido da Vigevano, *Texaurus* (1335)

Guido de Vigevano was the physician to the Queen of Burgundy. In 1328 he wrote a military treatise to his patron Phillip VI of Valois on techniques for conducting a successful crusade to the Holy Land. He was likely trained in his native city of Pavia, as well as Bologna. The principal copy of the manuscript is in the Paris Bibliothèque Nationale (MS 11015). Seven machine figures can be found in the seminal work of Gille (1966) on Renaissance engineers. A textural translation into English as well as a few figures can be found in the paper by Hall (1976b). The importance of this work, like that of Villard is that the military machines described anticipate the more precise drawings of Taccola, Francesco di Giorgio, Valturio, and Leonardo. For example there are drawings of a four-wheeled battle wagon, a folding bridge pontoon, a boat with barrel floats, wind driven wagon, scaling ladders and other devices for a mediaeval siege. The figures however, like those of Villard are flat and two-dimensional and are more iconic than technically descriptive.

Konrad Kyeser [1366–c. 1405?], *Bellifortis*

Kyeser was born in Eichstatt Bavaria. He is reported to have been a military consultant to many kings and princes of Germany, Austria, Bohemia and Bavaria. According to Gille (1966), the drawings for his book of war machines *Bellifortis* were drawn by another artist. This work is very colorful and includes fanciful drawings of mediaeval castles, costumes and banners. The machines represented in this book include attack towers, battering rams, trebuchets, pontoon bridges, cross-bows and scaling ladders. These machines were the stock devices for siege warfare. Also included is an Archimedes screw pump, chain-of-pots pump, a paddle wheel boat and a water wheel. The illustrations are flat looking, lack depth and solidity compared to those found in Francesco di Giorgio and Leonardo. Yet again as with many machine books of the early Renaissance we can find similar figures in the later work of Leonardo and 16th century artist engineers. A facsimile of *Bellifortis* has been published by the German Society of Engineers or VDI in 1967.

Giovanni Fontana [c. 1393–c. 1455], *Bellicorum Instrumentorum Liber*

Though the title translates as a book of instruments of war, this is mainly an early ‘theatre of machines’ picture book with almost no explanations. There is only one known copy of this manuscript in the State Library in Munich (Cod. Icon. 242). According to Gille (1966) Fontana had studied arts and medicine

in Padua and was appointed physician in the Republic of Venice and served from 1420–1432. He had also studied physics and natural science. A manuscript on physics and alchemy in the Bibliothèque Nationale in France is attributed to Fontana. His machine book contains colorful drawings of hydraulic devices, a few siege machines, designs for automata and a operator actuated, gear-driven four-wheel cart. The most curious drawings however are of designs for what one could call a winged devil automata. The mechanism consists of serial kinks for arms and flapping wings operated by a cable system to move the head, arms and wings (Folios 59v, 60r, 62r, 63v of the Cod. Icon 242 Munich). This design predates a similar pulley and linkage design for an automata of Leonardo da Vinci (see Rosheim, 2006). Luckily there is a facsimile copy of Fontana's work in print by Battisti and Battisti (1984) available in a number of university libraries.

Giuliano da Sangallo [c. 1445–1516], *Manuscript of construction machines*

Giuliano was an architect and engineer. He was a follower of Brunelleschi and a favorite architect of the Medicis, designing both palaces and fortifications, similar to the career of Francesco di Giorgio. His machine drawings are limited to 51 folios in the Siena City Library (Bibl. Comunale). The manuscript is labeled MS S. IV. 8 (BCS). A facsimile was published in Siena in 1902. The importance of these drawings is that they capture the features of the construction machines that Brunelleschi used to build the dome of the Cathedral in Florence. Some of these drawings are similar to designs in the drawings of Francesco di Giorgio and Leonardo da Vinci. Several drawings of Giuliano da Sangallo can be seen in the recent book of Galluzzi (1997).

Mariano Taccola [1382–c. 1460], *De Ingeneis* (c. 1450)

The Italian city-state of Siena was the birthplace of a number of early Renaissance artist-engineers who likely influenced the work of Leonardo da Vinci. Mariano Taccola was the son of a wine dealer and there are records that early in his life (1408) he worked as a wood carver for the Cathedral of Siena. He later became a scribe and secretary to a hospital and student dormitory. He was a friend of the sculptor Jacopo della Quercia. Taccola completed drawings for a manuscript on machines in 1433. His *Notebook*, now housed in the State Library in Munich, shows his interest in the work of the architect and engineer Filippo Brunelleschi whom he quoted often about inventions and construction machines. In 1449, Taccola completed his book *De machinis*,

dealing mostly with military machines. He also completed another work titled, *De ingeneis*, also dealing with machines. Parts of *De ingeneis* and the *Notebook* have been made available in facsimile and translated in English in 1984. (See list of references for details; see also Galluzzi, 1997.)

The facsimile edition, *De ingeneis*, (see Scaglio, 1984) contains large detailed isometric drawings of machines and applications that include both human and animal figures as sources of energy to drive these machines. The drawings sometimes contain textural material that describes some aspect of the machines. There are other drawings with no text at all. A good number of machines are related to military operations on land and water and include projectile throwing trebuchet devices as well as wheeled vehicles for moving cannon and wall scaling ladders. There are also drawings of bellows pumps, chain of pots on a pulley (Folio 96v) and the double piston pump (Folio 88r) described in Vitruvius. Basic machine elements include the screw and many toothed wheels with lantern pinions (Folio 65r) to drive pumps and mills. A slider crank pump is shown in Folio 82v. A lazy tongs design for a scaling ladder also found in Leonardo and later books in on Folio 127v.

Apparently Taccola did not travel much but received information about machines from other countries from visiting engineers. Like Leonardo, there is also little record that he actual built anything or supervised the construction of any major work. Taccola's textural notes are in the form of technical instructions rather than philosophic musings that one often finds in Leonardo:

If you wish to raise water rapidly from a well or cistern, provide a winch with buckets tied together by ropes. At one end thereof let it be turned by a toothed wheel of forty teeth and a pinion of seven or five teeth. (Folio 20v)

Of interest to the history of dynamics, Taccola drew a famous 'perpetual motion wheel' with folded pendulums (Folio 58r). This drawing also appeared in Leonardo's *Codex Madrid I* as well as later machine books. Many of these machines appear in the books of Francesco di Giorgio, Leonardo and 16th century authors. However there are very few industrial process machines of the kind that appear in Leonardo, Besson, Ramelli and Strada. (See Appendix II for a list of on-line books on the KMODDI website.)

Roberto Valturio [1405–1475], *De Re Militari* (c. 1455–1460, published in Verona, 1472)

Valturio was the secretary to Pope Eugene IV and was neither an artist nor military engineer. *De re militari* was commissioned by Roberto's patron, Sig-

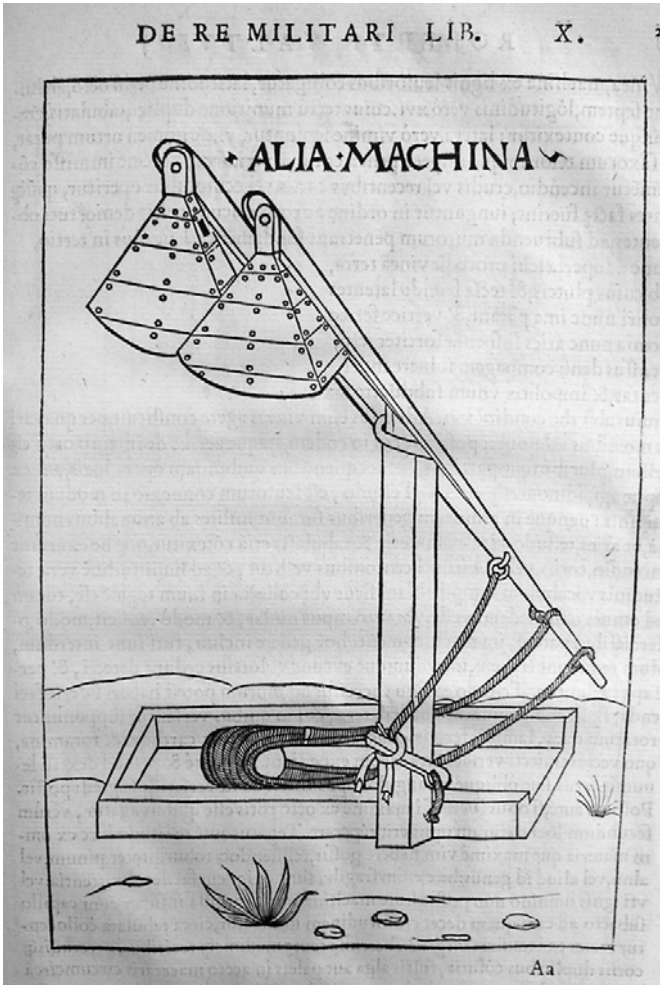

Figure IV.1. Theatre of Machines: Roberto Valturio (1472); Trebuchet siege machine

mondo Malatesta of Rimini as a summary of military techniques. Several sources attribute the drawings to an architect-painter named Matteo de' Pasti (see e.g. the website of the Institute and Museum for the History of Science (IMSS) in Florence). The *De re militari*, published originally in Latin in 1472 and in Italian in 1483, has similar figures found in Guido da Vigevano, Conrad Kyeser and Taccola. The work is divided into 12 books, with many of the machines in Book X. Among the machines illustrated are trebuchets (Figure IV.1), battering ram, siege ladders, folding pontoon bridge, a bellows pump, cross bows, moveable battle towers, gear-driven battle-wagon and an Archimedes pump. Some sources say that Leonardo had a copy of *De re mil-*

itari. For example a battle chariot with scythe blades on the wheels is similar to a design in the later work of Leonardo. (See Appendix II for a list of on-line books on the KMODDL website.)

Francesco di Giorgio Martini [1439–1501], *Trattato di architettura* (c. 1470–1480)

Francesco di Giorgio was born in Siena. His principal work in machine engineering exists in several manuscripts, the most quoted one being *Il Codice Ashburnham: manuscript 361* in Florence. Fortunately this work has been translated and published in facsimile in 1979 and is available in many libraries (see the Bibliography for details). Like Leonardo, Francesco was a respected painter, sculptor and architect. As an artist and architect he left a greater record of works than Leonardo but he is not as well known in the popular press. There is evidence that not only did Francesco di Giorgio carry the mantle of Taccola's engineering work forward but that Leonardo was influenced by Francesco's work in architecture and machine engineering. Widely respected, Francesco consulted as an engineer and traveled beyond Siena to Rome, Turin, Urbino, and Milan in 1490 where he met the younger Leonardo di Vinci.

The *Trattato* consists of 53 Folios or 106 plates, some of which have textual material as well as extensive drawings. Folios 1–32 deal mainly with architectural designs for forts, cities, churches, domes, measurement and surveying. The principal folios relating to machines are Folios 33–47. Following the work of Vitruvius and Taccola, there are designs for chain of pots pumps, mills, gearing and the famous dual cylinder balancier pump of Ctesibius described in Vitruvius. There is also a lumber sawing machine similar to that found in the Middle Ages work of Villard di Honnecourt.

Of special interest are designs for wheeled carts with steering, not unlike drawings for later in the Notebooks of Leonardo. Francesco also drew designs for winches, screw mechanisms, what appears to be a rack and pinion device and an amphibious boat design. There is also a design for a barge with a grapple to lift sunken cannon off the bottom of a sea or lake also found in Leonardo's Notebooks. There is evidence that Leonardo had a copy of Francesco di Giorgio's book in his library. The range of machines drawn by Leonardo, however, is greater than those of Francesco di Giorgio.

Vannuccio Biringuccio [1480–1538], *Pirotechnia* (1540)

Biringuccio was born in Siena. This work, like that of Agricola, treats mainly the technology of chemical processing and metallurgy. It is often cited in

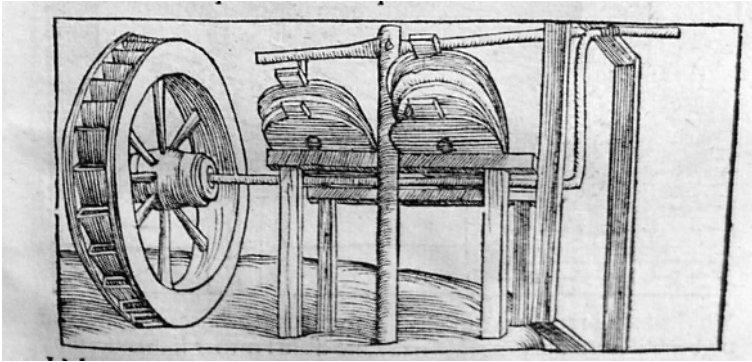

Figure IV.2. Theatre of Machines: Vannuccio Biringuccio (1540); Water wheel driven bellows

histories of machines but it contains very few figures related to machines, perhaps ten engravings. Biringuccio noted the importance in having a water-power source to run the bellows of metal producing workshops. The work is divided into 10 ‘books’. There are many figures related to chemical technology. Of the few on machines, one shows a water wheel connected to a cannon-boring machine. Others show water wheels driving large bellows for a furnace (Figure IV.2). As far as a source for machine history, it does not measure up to its contemporary works of Besson and Ramelli, nor even Agricola. For those who read German, Beck (1899) has a chapter devoted to Biringuccio with drawings showing machines driving bellows for metal processing.

Georgius Agricola [1494–1555], *De Re Metallica* (1556)

Georgius Agricola was born in Saxony. His father’s name was Georg Bauer, which means peasant or farmer. It is likely ‘Agricola’ is the Latinized form of the German, ‘Bauer’. He studied at the University of Leipzig and taught Greek and Latin at a school at Zwickau and later became a lecturer at the University in Leipzig. Agricola traveled to Italy where he studied philosophy, medicine and the sciences. He returned to a town near the mining area of Bohemia as a physician and when not attending to medical duties, visited many mines and smelters in the area. He later practiced medicine in Chemnitz, Germany. He worked on *De re metallica* for nearly 25 years.

De re metallica is the first modern comprehensive book on mining and the manufacture of metals. As such it contains many descriptions and pictures of mining machines including pumps and lifting machines as well as mill gearing and related machine elements. The work is divided into 12 books with Book VI containing the most machine descriptions. Beck (1899) (in

German) devoted a chapter to the work of Agricola with many illustrations of machines for mining operations.

Luckily for the English-reading student, Agricola's work was translated by the former President of the United States, Herbert C. Hoover in 1912 and was reissued in 1950.

Jacques Besson [c. 1540–c. 1576], *Theatre des instruments mathematiques et mechaniques* (1569–1578)

Jacques Besson was born in Briançon near Grenoble, France. He was reportedly engineer and mathematician to the king. He also served as professor at Orleans and died in Geneva. The association of mathematics and machines that continued from the time of Aristotle to Reuleaux is evident in the title page of Besson's treatise, in which he describes himself as a 'learned mathematican'. Besson's work is similar to that of Ramelli with many beautiful plates detailing different kinds of machines including a dredging device, screw cutting machine and a fire engine pump. He has a log-sawing machine that has antecedents in the drawings of Leonardo da Vinci, Francesco di Giorgio and Villard de Honnecourt. Several of Besson's machines use a human driven pendulum to operate the machine (see Figure IV.3). This concept of dynamic resonance to drive a machine was not in the earlier work of Leonardo. Also in contrast to Leonardo's drawings, Besson includes human machine operators in his drawings. Unlike Ramelli's work, Besson does not have war machines. The quality of his drawings is far superior to those of Taccola and Francesco di Giorgio a century earlier. Many of Besson's drawings were copied in later machine encyclopedias including one that was printed in China a century later. Besson's work can be viewed on the Dibner Library website of the Smithsonian Institution in Washington, DC.

Agostino Ramelli [c. 1531–c. 1610], *Le diverse et artificiose machine del capitano Agostino Ramelli* (The Various and Ingenious Machines of Agostino Ramelli, 1588)

Agustino Ramelli was born in Ponte Tresa, near Lake Lugano, north of Milan. He worked as a military engineer for several patrons including the French king Henry III. His machine book contains nearly 200 machines with a description of each machine. The original work was written in both Italian and French. The format consists of a beautiful engraved plate of a machine with an accompanying text on the opposite page. The descriptions are technical

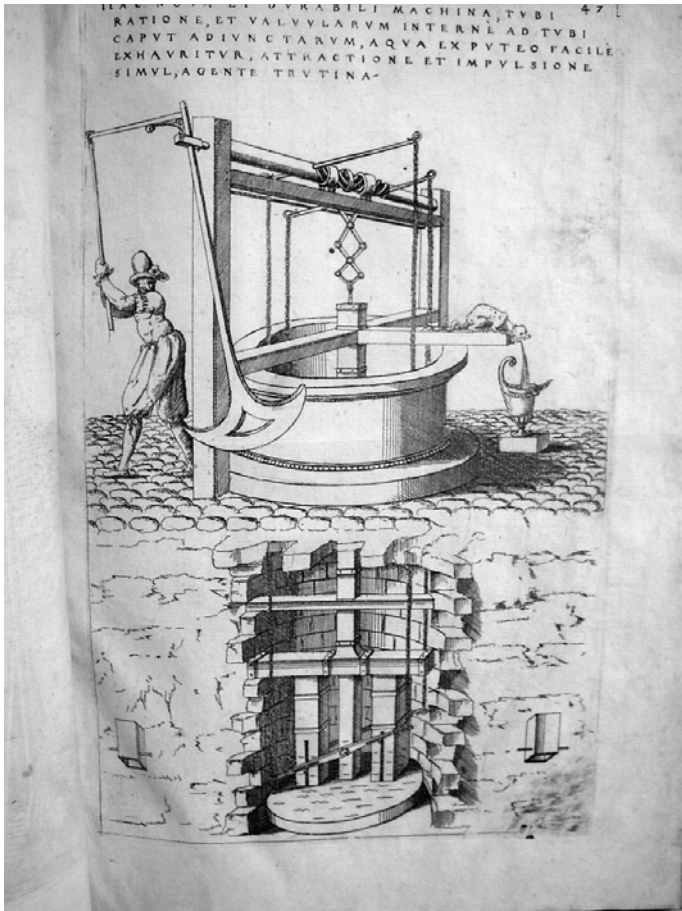

Figure IV.3. Theatre of Machines: Jacques Besson (1578); Nürnberg shears and pendulum driven pump

and to the point with no mathematical or philosophical discussion. His drawings exhibit great detail and some include cutaway drawings. The devices include gearing for water pumps, mills, construction cranes and machines as well as military machines such as a projectile throwing machine.

There is a noticeable influence of Francesco di Giorgio in a few plates and the work contains a toroidal pump similar to one drawn by Leonardo. However, Ramelli's work exhibits such clear detail that went beyond many of his predecessors. The book contains over 30 different types of pumps and shows a great variety of gearing.

There is a wonderful English translation by M.T. Gnudi and E.S. Ferguson (1976) with interpretive discussion of the machines and the impact of

Ramelli's work on later generations. *Ingenious Machines* has influenced the machine books of Zeising (1612), Strada (1617), Böckler (1662) as well as Leupold (1724). Böckler, for example, copied 18 plates from Ramelli's work. According to Ferguson, the Jesuits took copies of Western machine books to China, such as Besson and Ramelli, which were copied into a work entitled *Chhi chhi thu shuo* (Qi qi tu shou) (1627) translated as 'Diagrams and explanations of wonderful machines'.

Jacobus de Strada [1523–1588] *Künstlicher Abriss allerhand Wasser-, Wind-, Ross-, und Handt-Mühlen* (1617–1618) (A compendium of many kinds of water, wind, horse and hand mills)

The author of this work is not clear since this machine book was published by the grandson of Jacobus, Octavius de Strada. However according to Keller (1964) records do not show that Jacobus had any training connected with machines. Some of the drawings seem to have antecedents in Agricola. The cover of this book is handsomely decorated with images of Archimedes and Vitruvius (Figure IV.4). Strada's book can be viewed on the website KMODDL under References (see Appendix II, below).

Jean Errard de Bar-Le-Duc [c. 1554–1610], *Le Premier Livre des Instruments mathematitque mechaniques* (1584)

Jean Errard was born in the western French village of Bar-Le-Duc to parents of noble background. At some time he professed Protestant beliefs. He studied mathematics and geometry at the University of Heidelberg around 1573. His Protestantism did not prevent him serving Charles III, Duke of Lorraine. In 1584 he published his book *Le premier livre des instruments mathématiques* in Nancy, financed by the Duke. During the religious wars, he served as a military engineer. His reputation later earned him an invitation to serve Henry IV, King of France. Errard like Francesco di Giorgio, designed many fortifications and wrote a manuscript on the geometry of fortifications. The King named Errard '*ingenieur ordinaire de fortifications*' in 1599. In his earlier book on machines, he had 40 plates, many illustrating the use of the pulley and gear systems. The drawings show construction cranes and hoists, some for lifting boats out of the water. He also has several designs for windmills, water pumping systems, a couple of textile spinning devices and a lathe. The drawing technique shows a ground grid as well as machine operators, that help give some scale and relative dimensions. There are also several machine drawings with isolated sub-components showing details of construction.



Figure IV.4. Theatre of Machines: Jacobus de Strada (1617); Cover with images of Archimedes and Vitruvius

Heinrich Zeising [?–1613?], *Theatrum Machinarum* (Leipzig, 1612)

The drawings in this book do not have the quality of Ramelli and Besson and a number of machines appear to have been copied from earlier machine books. German readers can find a chapter on Zeising's book in Beck (1899). (See Appendix II for a list of on-line books on the KMODDL website.)

Vittorio Zonca [1568–1603], *Novo teatro di machine et edificiij* (Padua, 1607)

Very little is known about Zonca. The title of his book describes him as an architect to the city of Padua. His illustrations are on a par with those of Ramelli and Besson (Figure IV.5). Some references in his book suggest that a few of his machines were actually built. Zonca's book can be viewed on the website KMODDL under References (see Appendix II below).

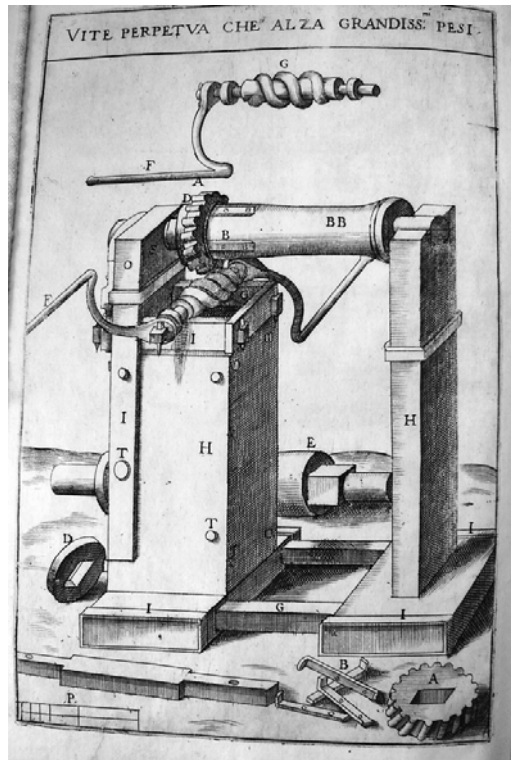

Figure IV.5. Theatre of Machines: Vittorio Zonca (1607); Endless screw and winch

Salomon de Caus [1576–1630], *Les Raisons des Forces Mouvantes* (Paris, 1615)

Salomon de Caus was a Renaissance engineer who worked for a time in Heidelberg. One of the unique features of his work is the design of full-scale automata based on the work of Hero of Alexandria. One of his designs is a garden for the Duke of Burgandy's palace in Saint Germain outside of Paris in which he animated figures, birds, animals and dragons. He used water-power to drive gears, levers and copper cables that moved parts of the statues. The program information was stored on cylindrical cams. De Caus also designed solar powered fountains and automata or so-called 'sun-machines'. He used a lens to focus the sun's rays on a container of water that was connected to a fountain or used hot air to play two organ pipes (see Strandh, 1979). Beck (1899) devoted a chapter to De Caus' book. De Caus' book can be viewed on the website KMODDL under References (see Appendix II below).

Johann Schreck (J. Terentius) and Wang Cheng, *Qi qi tu shou* (1627) (Chhi Chhi Thu Shou, pre PRC transliteration), *Diagrams and Explanations of Strange Machines*

This work is not an original source of machine designs but is a marker in the transmission of machine knowledge between cultures. The work followed the Christian Jesuit missionaries into China. Schreck, who was born Swiss and studied with both Galileo and Kepler, apparently knew of the work of Ramelli, Besson and Strada and either copied or had Chinese scholars copy the drawings. This three-volume work contains a discussion of basic principles of mechanics, simple machines and applications of more complex machines copied from the earlier European machine books. According to Joseph Needham who wrote the seminal work on science and technology in China, Wang Cheng was a scholar in Beijing. He is known as the first 'modern Chinese engineer' and published some of his own machine designs in another book entitled 'Chu Chhi Thu Shuo' also in 1627. Needham's work (Vol. 4, Part 2) on mechanical engineering in China, compared many of the European designs of machines with those that appeared in Chinese artifacts and manuscripts.

Georg Andreas Böckler [1648–1685], *Theatrum Machinarum Novum/Schauplatz der mechanischen Künsten* (Nürnberg, 1661)

On the title page, Böckler calls himself 'architect and engineer'. This book, written in German and part Latin, has many full plates with detailed illus-

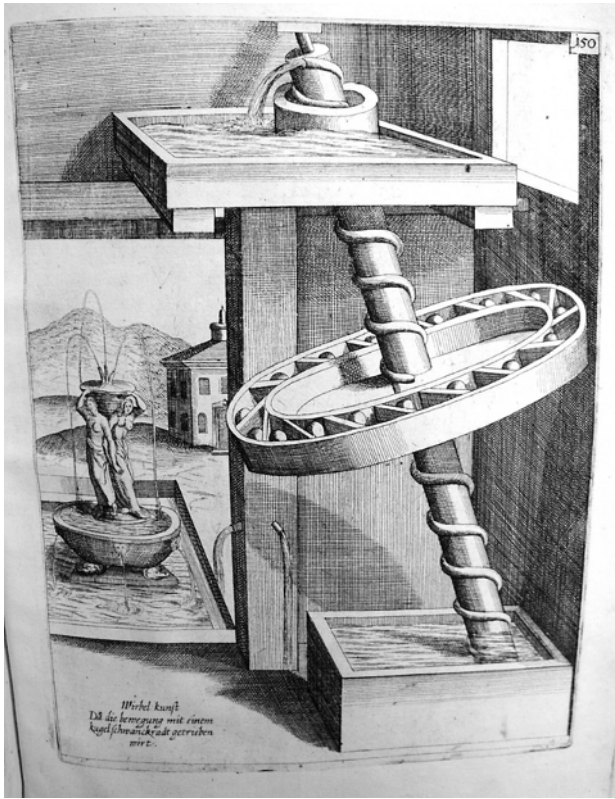

Figure IV.6. Theatre of Machines: Georg Bockler (1661); Perpetual motion machine design

trations of machines similar to earlier books of Besson and Ramelli a century before. Included are wind machines, water driven pumps including the dual cylinder valve pump described by Vitruvius. There is also a fire engine pump and a unique large, verge and foliot clock escapement to regulate the motion of a large chain-of-pots pump. Bockler had an interest in perpetual motion machines that manage to pump water and at the same time drive the machine (Figure IV.6). In Arthur Ord-Hume's 1977 monograph on perpetual motion machines, he describes at least six such impossible devices designed by Bockler. Bockler's book can be viewed on the website KMODDL under References (see Appendix II, below).

Giovanni Branca [1571–1640], *Le machine* (Rome, 1629)

This book contains 77 full-page woodcut plates. One of the plates shows a steam turbine often cited as one of the first designs for a steam powered machine. Steam from a vessel is directed against buckets on an impellor wheel.

The turbine is connected via a lantern pinion and crown gear to a cam that drives two hammers that are used to pulverize some material. The drawings in this work are not as artistic as those in Besson, Ramelli or Zonca. He was employed in Loreto Italy as an engineer attending to fortifications and other government projects. In addition to his book on machines, he also published a manual on architecture.

Phillipe De Le Hire [1640–1718], *Traite de mecanique* (Paris, 1695)

This work does not have large plates as earlier machine books. His book is written as a series of propositions about machines and focuses on mechanisms rather than entire machines. De le Hire had no formal training but appears to have studied mathematics, mechanics and astronomy. De le Hire was a member of the French Royal Academy of Science and held the title of Royal Professor of Mathematics. In one drawing he has an unusual three-tooth escapement that was used in an intermittent mechanism to drive a reciprocating saw (Figure IV.7). In another diagram he has a sinusoidal cam with a positive

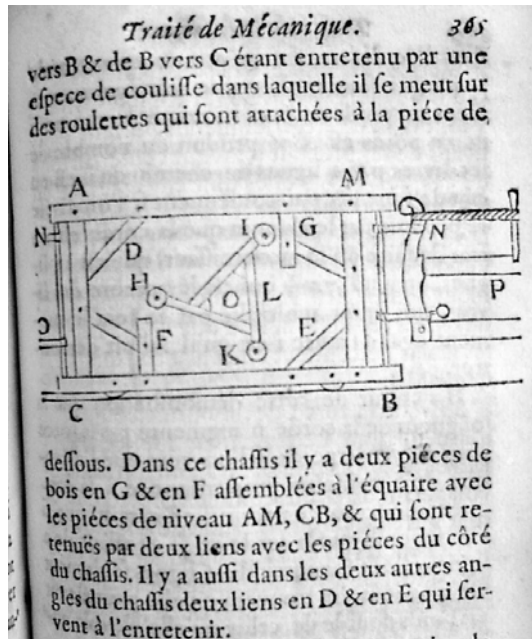

Figure IV.7. Theatre of Machines: Phillipe De le Hire (1695); Three-tooth escapement

return follower wheel. He also shows a bevel lantern pinion similar to that found in Leonardo. He is one of the first to consider an epicycloid shape for gear teeth.

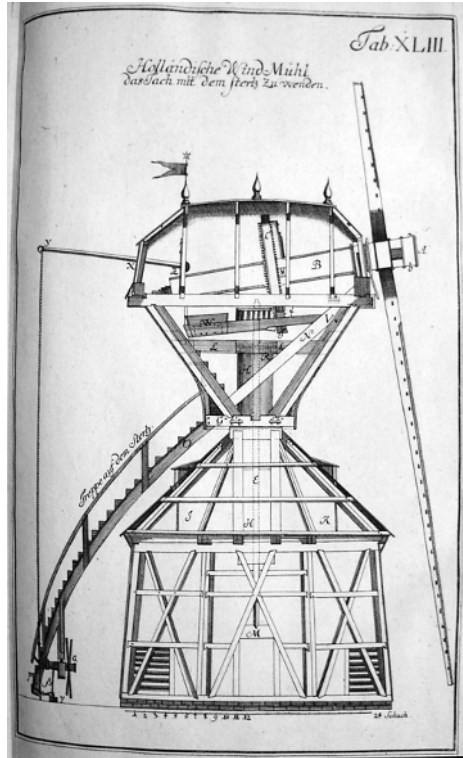

Figure IV.8. Theatre of Machines: Jacob Leupold (1724); Windmill

Jacob Leupold [1674–1727], *Theatrum machinarum generale/Schau-Platz des gründse mechanischer Wissenschaftten/das ist: deutliche Anleitung zur Mechanic oder Bewegungs-kunst* (Leipzig, 1724)

This work is one of the first machine books to describe basic machine elements as well as applications of machines. There are 24 chapters and 71 plates, some with up to 10 drawings or figures. A few of the topics treated include arrangements of pulleys, gear trains, construction of toothed wheels or gears, varieties of endless screws, cranks, flywheels, ratchets, alternating mechanisms, lazy tongs, bearings, cylinder pumps, windmill design (Figure IV.8), water turbine wheels, and a Papin vacuum pump. Some of the

mechanisms remind one of drawings in Leonardo's Notebooks such as designs for bearings. Like Böckler (1662) a century earlier, Leupold had a fascination with perpetual motion machines, especially of the self-turning wheel with moving balls (see e.g. Ord-Hume, 1977). Leupold also published a machine book devoted to hydraulic machines. Reuleaux credits Leupold with attempting to list the constructive elements common to all machines.

Leupold (1724) seems to be the first writer who separates single mechanisms from machines, but he examines these for their own sakes, and only accidentally in reference to their manifold applications.

Leupold's books can be viewed on the website KMODDL, under References (see Appendix II below).

Denis Diderot [1713–1774] and Jean d'Alembert [1717–1783],

Encyclopédie, ou, Dictionnaire raisonne des sciences, des arts et metier
(1751–1772)

This heroic work of 17 textual and 11 figurative volumes is distinguished from earlier attempts in that it contains not only knowledge in the arts and sciences but also the crafts and manufacturing trades. There are hundreds of drawings, many containing pictures of working machines of the 18th century. For example there are volumes on machines in mining, agriculture, textiles and horology. The figures are on large plates and the drawings feature cut-away views that rival the best modern CAD drawings today. In spite of the sophistication of the machine drawings, however, many of the machine components and mechanisms shown in this work show little advance over those in the Renaissance such as the use of crown wheel and lantern pinion gear pairs.

Diderot was born in Langres, France and received a Jesuit education, though he did not study for the clergy, choosing law and mathematics instead. He worked for publishers and was soon asked to translate Chamber's *Cyclopedia*, into French. He had a bigger vision of a grand compendium of knowledge that would counter the backwardness of the church and state. He assembled a team of experts in both the humanities and sciences, J. Le Rond D'Alembert among them who initially was a co-editor but resigned in 1758. Though the *Encyclopédie* did not directly attack the Church, there were many critics throughout the early years of its publication. Diderot also wrote plays and novels.

A DVD version of Diderot's *Encyclopedie* can be found in many libraries as well as on the web and recently a French publisher has produced a facsimile edition.

APPENDIX II: ON-LINE BOOKS AND PAPERS AT CORNELL UNIVERSITY LIBRARY ON THE HISTORY OF MACHINES AND MECHANISMS

[<http://kinematic.library.cornell.edu:8190/> or
<http://kmoddl.library.cornell.edu>]

- Babbage, Charles (1826) On a Method of Expressing by Signs, The Action of Machinery, *Phil. Trans. Royal Soc. London* **116**, 250–265.
- Bickford, John H. (1972) *Mechanisms for Intermittent Motion*, Industrial Press, Inc., New York.
- Böckler, Georg Andreas (1661) *Theatrum Machinarum Novum*, Nürnberg, In Verlegung Paulus Fürsten, Gedruckt bey Christoff Gerhard.
- Borgnis, J.-A. (1818) *Traité complet de mécanique appliquée aux arts*, Bachelier, Libraire, Paris.
- Brown, Henry T. (1871) *Five Hundred and Seven Mechanical Movements*, Brown, Coombs & Co., New York.
- Carnot, Lazare (1803) *Principes fondamentaux de l'équilibre et du mouvement*, Bachelier, Paris.
- Durley, R.J. (1903) *Kinematics of Machines*, John Wiley & Sons, New York/Chapman & Hall, Ltd., London.
- Euler, Leonhard (1765) *Theoria motus corporum solidorum seu rigidorum*, Rostochii, Gryphiswaldiae, Litteris et impensis A.F. Rose.
- Evans, Oliver (1834) *The Young Mill-Wright and Millers Guide*, Carey, Lea & Blanchard, PA.
- Ferguson, Eugene S. (1962) Kinematics of Mechanisms from the Time of Watt, *United States National Museum Bulletin* **228**, Paper 27, 185–230.
- Gosner, Kenneth L. (1954) Mechanical Models: A Collection of the Newark Museum, *The Museum* **6**(3) (Summer), 1–24.
- Gradenwitz, Alfred (1908) The Mutual Relations of Geometry and Mechanics and Prof Reuleaux's Mechanical Movements, *Scientific American*, March 21, 204–205.
- Grübler, Martin (1917) *Getriebelehre*, Julius Springer, Berlin.
- Hachette, J.N.P. (1811) *Traité Elementaire des Machines*, J. Klostermann fils, Paris/Saint-Pétersbourg.
- Hartenberg, Richard and Jacques Danavit (1964) *Kinematic Synthesis of Linkages*, McGraw-Hill, New York.
- Kennedy, Alex B.W. (1876) Book Review: *The Kinematics of Machinery; Outlines of a Theory of Machines*, Reuleaux, Translated by A.B.W. Kennedy, *Engineering* **22**, 197.
- Kennedy, Alex B.W. (1876) The Berlin Kinematic Models, *Engineering* **22**, 239–240.
- Kennedy, Alex B.W. (1881) The Kinematics of Machinery, Two lectures relating to Reuleaux Methods, Delivered at South Kensington Museum, D. Van Nostrand, New York.
- Kennedy, Alex B.W. (1886) *The Mechanics of Machinery*, Macmillan, London.
- Laboulaye, Charles Pierre Lefebvre de (1861) *Traité de cinématique, ou Théorie des méchaismes*, E. Lacroix, Paris.
- Lanz, Philippe Louis (1817) *Analytical Essay on the Construction of Machines*, Translated from the French of Lanz & Betancourt, R. Ackermann, London.

- Leonardo da Vinci (1493, 1974) *Codex Madrid I*, The Madrid Codices: National Library Madrid, Facsimile Edition of Codex Madrid I (Original Spanish Title: *Tratado de Estatica Y Mechanica en Italiano*), Library Number 8937, Switzerland, McGraw Hill, 1974 (1493).
- Leupold, Jacob (1725) *Theatri Machinarum Hydraulicarum Tomus I*, Zufindenn bey dem Autore und Joh. Friedr. Gleditschens seel. Sohn, Druckts Christoph Zunkel, Leipzig.
- Leupold, Jacob (1725) *Theatri Machinarum Hydraulicarum Tomus II*, Zufindenn bey dem Autore und Joh. Friedr. Gleditschens seel. Sohn, Druckts Christoph Zunkel, Leipzig.
- Leupold, Jacob (1725) , *Theatrum Machinarum Generale*, Zufindenn bey dem Autore und Joh. Friedr. Gleditschens seel. Sohn, Druckts Christoph Zunkel, Leipzig.
- Newark Museum (1930) *Mechanical Models*, The Newark Museum, Newark, NJ
- Poinsot, Louis (1834) *Outlines of a New Theory of Rotatory Motion*, Translated from the French, with explanatory notes by Charles Whitney, R. Newby, Cambridge.
- Rankine, William J.M. (1887) *A Manual of Machinery and Millwork Vol. 1*, Charles Griffin & Co., London.
- Rankine, William J.M. (1887) *A Manual of Machinery and Millwork Vol. 2*, Charles Griffin & Co., London.
- Redtenbacher, F. (Ferdinand Jacob) (1866) *Die Bewegungs-Mechanismen*, F. Bassermann, Heidelberg.
- Reuleaux, Franz (1877) *Briefe aus Philadelphia, A Series of lectures*, F. Vieweg und Sohn, Braunschweig.
- Reuleaux, Franz (1875) *Lehrbuch der Kinematik, Vol. 1, Theoretische Kinematik: Grundzüge einer Theorie des Maschinenwesens*, F. Vieweg und Sohn, Braunschweig.
- Reuleaux, Franz (1875) *Lehrbuch der Kinematik, Vol 2, Die praktischen Beziehungen Kinematik zu Geometrie und Mechanik, Grundzüge einer Theorie des Maschinenwesens*, F. Vieweg und Sohn, Braunschweig.
- Reuleaux, Franz (1876) *Kinematics of Machinery: Outlines of a Theory of Machines*, Translated by A.B.W. Kennedy, Macmillan and Co., London.
- Reuleaux, Franz (1885) The Influence of the Technical Sciences upon General Culture, Translated by W. Kunhardt, *School of Mines Quarterly* **VII**(1) (October), 67–94.
- Reuleaux, Franz (1894) *The Constructor: A Handbook of Machine Design with Portrait and over 1200 Illustrations*, H.H. Suplee, Philadelphia.
- Schröder, J. (1899) *Catalog of Reuleaux Models* (Illustrationen von Unterrichts-Modellen und Apparaten), Polytechnisches Arbeits-Institut, Darmstadt.
- Scientific American* (1885) Sibley College, Cornell University: New Schools of Mechanical Engineering and Mechanical Arts, *Scientific American* **LIII**(16) October 17 (New Series).
- Strada, Jacobus (1617–1618) *Kunstliche Abrisz allerhand Wasser-Wind-Rosz-und Handt Muhlen*, Getruckt durch Paulum Iacobi in Verlegung Octavii de Strada, Franckfurt am Mayn.
- Taccola, Mariano (1984) *De Ingeneis, Vol. II, The Notebook*, Taccola's Introduction, Drawings of Engines and Latin Texts, Descriptions of Engines in English Translation. Editorial Notes by Gustina Scaglia, Frank Prager and Ulrich Montag, L. Reichert, Wiesbaden.
- Thurston, Robert H. (1894) *The Animal as a Machine and a Prime Motor*, John Wiley & Sons, New York.
- Thurston, Robert H. (1902) *A History of the Grown of the Steam Engine*, D. Appleton, New York.
- Valturio, Roberto (1535) *De re militari libris XII*, Apud Christianum Wechelum, Parisiis.
- Voigt, G. (1907) *Kinematische Modelle nach Prof Reuleaux* (A Catalog of the Kinematic Models of Professor Reuleaux, in 2 sections).
- Voigt, G. (1907) *Kinematische Modelle nach Prof Reuleaux* (Description and Price List).

- Wankel, Felix (1963) *Rotary Piston Machines: Classification of Design Principles for Engines, Pumps and Compressors* (Translation of *Einteilung des Rotations-Kolbenmaschinen*), ILIFFE Books Ltd., London.
- Weisbach, Julius (1848–1849) *Principles of the Mechanics of Machinery and Engineering, Vol. 1*, Lea and Blanchard, Philadelphia.
- Weisbach, Julius (1848–1849) *Principles of the Mechanics of Machinery and Engineering, Vol. 2*, Lea and Blanchard, Philadelphia.
- Willis, Robert (1841) *Principles of Mechanism*, John W. Parker, London.
- Willis, Robert (1851) *A System of Apparatus for the Use of Lecturers and Experimenters in Mechanical Philosophy*, John Weale, London.
- Zeising, Heinrich (1613?–1614) *Theatri machinarum erster*, Leipzig.
- Zonca, Vittorio (1656) *Novo teatro di machine et edificii per uarie et sicure operationi*, Appresso F. Bertelli, Padoua.
- Zopke, Hans (1896) Professor Franz Reuleaux, A Biographical Sketch, *Cassiers Magazine*, **XI**(2) (December), 133–139.

APPENDIX III: STUDENT EXERCISES IN THE HISTORY OF MACHINES

It is the Author's hope that some of the material in this book will find its way into the curriculum of engineers, architects and historians. Engineering students might find the variety of mechanisms in Leonardo's drawings of value in machine design and architectural students might find the comparisons of design and style in machines between the Renaissance and Industrial Age of interest. In the spirit of Ferguson's *Engineering in the Mind's Eye* (1992) on the value of non-textual, non-verbal learning in science, we list a number of homework and student projects that could be used in both design and history of science and technology courses.

The Author is aware of several universities that are using historical artifacts in design technology courses. At Cornell University, Professor Hod Lipson teaches a creative design course for mechanical engineering sophomores using models from the Reuleaux Collection. Students use the KMODDL website on kinematic mechanisms to make CAD drawings. (SOLID WORKS with animation.) In some cases the computer models that can be printed in a rapid prototype machine. At Princeton University there is a course on the history of technology in which students construct prototypes of historic inventions such as the Morse telegraph, or they make a model of the Eiffel tower and test the strength under load and relate their results to analytical calculations. Students at the University of Porto, which has a fine collection of Reuleaux–Voigt models, are also using the collection to help learn CAD drawing skills.

The Problems below are divided into three categories:

- (i) History,
- (ii) Drawing, Design & CAD, and
- (iii) Models & Experiments.

The numbers in brackets show the book sections relevant to the problem or project.

HISTORY BASED PROJECTS

H1. (Sections I.4, I.5) One of the graphical tools in studying the evolution of technology, is an influence chart or diagram. Take a modern technical artifact, such as a robot, and trace its path back as far as one can using solid links for direct influences and dotted links for indirect influences. Code the nodes in the diagram with different symbols for different countries. Trace

back at least two centuries. A good example is the internal combustion engine.

H2. (Sections II.3, II. 4) Find an English translation of the Roman engineer Vitruvius, whose work was translated by Francesco di Giorgio and was referenced by Leonardo da Vinci (e.g Morgan, 1914 or Gwilt, 1874). Read carefully Book X that describes various machines. Give a description of six of these machines as well as their Latin names (see e.g. Drachmann, 1963).

H3. (Section II.9) Compare the drawings in the machine book of Ramelli (1588) (Dover Edition) and those of Leonardo's *Codex Madrid* (KMODDL or recent Guinti facsimile) and make a chart of similar machine components.

H4. (Section II.9) Trace some of the paths of machine evolution in early China. What role did contact between Europe and Asia play in the evolution of machine engineering in both China and Europe (see e.g. Needham, 1965).

H5. (Section II.11) Take a volume of paintings of an artist, such as Vincent van Gogh and make a list of the technical artifacts contained in his or her drawings. Also look at earlier Dutch painters.

H6. (Section II.11, II.12) Discuss some of the architectural drawings of Leonardo da Vinci in the context of modern architectural theory and history.

H7. (Section II.11) Futurism was an art movement in the early 20th century. Discuss in what ways the machine was or was not an important icon or symbol to these artists (see e.g. Pontus Hulten, 1968, the catalog of a exhibition on the machine in art held at the Museum of Modern Art in New York).

H8. (Sections II.14, II.18) Discuss why the United States was late in using and developing the steam engine (see e.g. Hindle and Lubar, 1986).

H9. (Sections II.14, II.18) Write a short paper on the life and inventions of the American inventor Oliver Evans. Compare his life with that of James Watt.

H10. (Section II.15) Review the political revolutions of 1848 in Germany and Europe and investigate whether engineers such as Redtenbacher, Reuleaux and others played any role in this movement.

H11. (Section II.19) Construct an influence chart with annotations chronicling the history of flight from the late 18th to the early 20th century. Include balloon, gliders and manned flight.

H12. (Section II.19) Make a detailed study of the aeronautical experiments of Otto Lilienthal and compare his glider designs with the aeronautical drawings of Leonardo.

H13. (Section II.21) Construct an influence diagram for robotic technology. Trace the relation between modern robotics and automata back to the Arab 13th century and perhaps to the ancient Greeks and the automata of Hero. See e.g. Rosheim (2006) and Wood (2003).

DRAWING, DESIGN AND CAD PROJECTS

D1. (Section I.1) Consider the ‘*elementi macchinali*’ or basic machine elements of Leonardo da Vinci enumerated in Part III. Design a machine using at least three of these elements.

D2. (Sections I.2, II.12) Using wood dowels and thin plywood, construct a crown-wheel gear and lantern pinion as designed by Leonardo (see e.g. Figure I.12b or *Codex Madrid I*, Folio 30v).

D3. (Section I.3) Take one of Leonardo’s drawings of a machine, such as his textile spinning machine in Figure I.15 (CA Folio 1090v) or ratchet wrench in Figure I.16 (CA Folio 30v) and create a standard three-view drawing and isometric of the machine by hand or with a CAD program. Note that you will have to ‘invent’ some of the details not shown in the original drawing.

D4. (Section I.3) Identify a machine drawing of Leonardo da Vinci from a popular book and make a CAD model with a parts list and estimate the cost to make it today. For example consider the thread-spinning machine from the *Codex Atlanticus*, Folio 1090v (in the new numbering system).

D5. (Section II.10) The *cycloid* and related mathematical curves such as the epicycloid played a major role in early astronomy as well as in the design of gear teeth. Cut out a circular shape from cardboard or thin plastic. Puncture or drill a set of small holes along a radial line from the center to the edge just big enough for a pencil tip. Place the circle on a straight edge such as a long ruler and put a pencil or pen tip in one of the holes and slowly roll the circle

along the straight edge without slipping. You might have to tape down the ruler. The wonderful curves are from the cycloid family. Can you figure out how to draw epicycloids, trochoids and hypocycloid curves in a similar way?

D6. (Section II.11) The kinetic sculpture of Arthur Ganson can be found on the web. Sketch one of his machines and identify the machine elements and kinematic mechanisms. Determine which of these machine elements and mechanisms were known in the manuscripts of Leonardo da Vinci.

D7. (Sections I.7, II.17) Sketch the Reuleaux model of the *Peaucellier straight-line mechanism* (S-35) in the Voigt catalog, see also KMODDL. Identify the number of joints and links and use the mobility criterion Grübler to find the number of degrees of freedom of the mechanism. Cut out links from thin plastic and connect with pins and demonstrate the straight-line property (see e.g. Henderson and Taimina, 2004, or KMODDL Tutorial).

D8. (Section II.17) The drawing of geometric shapes made up of circular arcs called *lunate curves* was popular in the Renaissance. One special lunate is a *curved triangle* drawn with arcs from the vertices of an equilateral triangle. The curved triangle has the property of having a constant width and can rotate between two parallel lines without losing contact with both lines. This property was used in cams to control the valves of steam engines. Cut out two such curved triangles (called Reuleaux triangles by mathematicians today) and place them between two rulers. Move one ruler parallel to the other while the two curved triangles roll between them. Try making a curved pentagon of constant width. (Look at Reuleaux's models in the Voigt B series.)

D9. (Section II.17) Use a CAD program to draw a curved triangle (the so-called *Reuleaux triangle*). Fit the triangle in a square or rhombus shaped bearing and move the triangle relative to the bearing. Plot the path of the center of the curved triangle. (Look up the Reuleaux triangle on KMODDL in the Voigt B series.)

D10. Take one of Reuleaux's kinematic models such the slider crank mechanism in Model C-2 (Figure III.2b) or the universal joint in Model P-1 (Figure III.4b) and make an exploded-view drawing of the model by hand or using CAD software.

D11. Take one of the historical kinematic models of Reuleaux (see Part III) from the website <http://kmoddl.library.cornell.edu>, and make a CAD drawing using a standard drawing software. With more advanced software (e.g. SOLID WORKS), connect the parts so that the mechanism can be animated.

MODELS AND EXPERIMENTS

M1. (Sections I.2, I.3) Take an old motorized toothbrush of the \$3–\$5 variety and carefully take it apart. Identify the mechanical components and try to find counterparts in the mechanisms drawn by Leonardo da Vinci.

M2. (Sections I.3, II.12) Leonardo and other engineers of the Renaissance used lantern pinions and crown wheel gears with pegs as toothed wheel pairs. Use a wooden or plastic thread spool as a form for a lantern pinion with a wooden dowel as a shaft. Construct a crown wheel gear from a food container cover and glue small dowels for the teeth around the circumference. Note that the pitch of the lantern posts and the crown wheel teeth must be identical. Use a piece of Styrofoam to support two shafts and animate the kinematic pair. (See the drawing in the Dover reprint of Ramelli (1588) and the sketch on page 566, Figure 56.)

M3. (Sections II.3, II.4) The Archimedes screw pump has roots in ancient Egypt and was used in pump designs in numerous ‘theatre of machines’ books. Take some clear plastic tubing of at least a 3/4 inch (2 cm) diameter and wrap it around a wooden dowel of about 1–2 inches (2.5–5 cm) diameter. (Such clear tubing can usually be found in a hardware store.) Place the helical tube in a bucket of water at an angle of about 45 degrees and slowly turn the tube and see if you can make the water rise up the tube. Once you have it working you can design a structure and bearings to hold your ancient pump (see Drachmann, 1963, or Strandh, 1989).

M4. (Section II.9) Many ‘theatre of machine’ books contain designs for projectile throwing war machine called a ‘trebuchet’. Leonardo da Vinci has several designs in his *Codex Atlanticus* (CA Folio 160a-r). Modern designs can be found on the web. The trebuchet is a double pendulum dynamic mechanism that also incorporates an elastic energy storage or spring. Under supervision, design, build and test a small trebuchet along the lines of Leonardo. Can you estimate the efficiency of this ancient machine comparing the elastic energy storage with the kinetic energy of the moving object. (This experiment requires attention to safety when propelling the object.)

M5. (Section II.10) Leonardo showed that the volume of a cube could contain six tetrahedra of equal volume. See Figure II.13 from *Codex Madrid II*, Folio 70r. Use paper to fold and construct two different tetrahedra and show that one can construct a cube as per Leonardo's rule.

M6. (Section II.10) Leonardo measured the coefficient of friction for many pairs of surfaces, which is the ratio of the force before sliding to the normal force between the block and the surface. Use a block on an inclined plane. Raise the plane until the block slides. Use this angle to measure the coefficient of friction. Do you get a number close to Leonardo's value of $1/4$?

M7. (Section II.14) There is a German model maker (Wilesco®) who still produces small hobby steam engines along with a catalog of miniature machine tools. Teachers can order a working steam engine for less than 100 Euros. The engine comes with fuel pellets and a small boiler. After getting the engine to run, try to estimate the efficiency of the engine and compare with the efficiency of the Watt and Newcomen engines of the 18th century. The web address of the company: www.wilesco.de and email address; wilesco@aol.com. (Oddly the name of the distributing company is Wilhelm Schröder & Co. Lüdenscheid. It is not known if this name is related to the Darmstadt company named Schröder that produced Reuleaux models in the 19th century.)

M8. (Sections II.14, II.17) Using wooden 'popsicle' sticks or thin plastic strips, make a model of James Watt's straight-line mechanism that he used to produce a straight path for his piston motion. (See e.g. Ferguson, 1962, or the KMODDL website, click on References.)

M9. (Section II.14) Using a cylindrical cavity, such as an empty food can, built a piston and see if one can experimentally measure the expansion of water into steam and find the ratio that Leonardo reported.

M10. (Section II.21) Both Leonardo and Reuleaux were interested in clock escapements. Construct an escapement and measure the period under a heavy weight (see e.g. Bruton, 1979 or Reuleaux–Voigt models, X series, on KMODDL).

M11. (Section II.21) Mechanisms for a possible 'robot knight' are shown in Figure II.46, Section II.21. More detailed drawings and models are found

in Rosheim (2006). Use pulleys, cable, gear wheels and cam mechanism to design a small automaton doll.

M12. (Section II.21) In problem M11 the motors and controller for a 'robot knight' can be found in a LEGO Mindstorms™ kit for students or classrooms that have this system. Use the LEGO motor block with two motors, to control cable spools that actuate the cable-pulley system that will move two arms back and forth. Program the microprocessor to move the arm motors together to hold or release some object.

Author Index

- Adams, B., 364
Agricola, Georgius, 46, 147, 351, 369, 379
Alberti, Leon Battista, 263, 351, 368
Al-Jazari, Ibn al-Razzaz, 118, 121, 147, 278, 351, 369, 373
American Machinist, 58
Ampere, A-M., 66, 351, 365, 366
Archimedes, 111, 351
Aristotle, 107, 108, 351
Aronhold, S.H., 94, 351
Artobolevsky, I.I., 145, 351, 370
Atalay, B., 265, 351, 364, 368
- Babbage, C., 31, 54, 242, 351, 366
Bacon, Roger, 119, 257, 351
Barr, J.H., 205, 351
Bassala, G., xii, 351, 365
Battisti, E., 351, 375
Beck, T., 63, 64, 114, 146, 148, 169, 195, 351, 364, 379, 384
Bennett, G.T., 351
Bennett, S., 286, 287, 352
Beohn, von M., 279, 352
Bernheim, C., 352
Besson, J., 27, 46, 62, 132, 147, 150–152, 198, 310, 352, 380
Betancourt, A. de, 61, 67, 146, 147, 156, 180
Bevan, T., 352
Bezerra, C.A.D., 368
Bickford, J.H., 326, 352
Biringuccio, Vannuccio, 46, 147, 352, 378
Blake, R., 104, 355
- Böckler, Georgius, 62, 135, 144, 147, 152, 154, 155, 254, 352, 385
Boltyanskii, V.G., 241, 363
Borelli, G.A., 368
Borgnis, J.A., 79, 85, 144, 147, 156, 157, 268, 286, 352, 367, 368
Bottema, O., 352
Branca, Giovanni, 62, 249, 352, 386
Braun, H.J., 352, 367
Brose, E.D., 352
Brown, H.T., 156, 158, 312, 324, 328, 334, 352, 370
Bruton, E., 334, 352
Buckingham, E., 352
Burckhardt, J., 352, 366
Burmester, L., 95, 166, 241, 352, 367
Burstall, A.F., 352
Bush, V., 242, 352
Butler, S., 233, 352
- Calvert, M., 227, 352, 365
Cambridge University Engineering Department, 352
Canestrini, G., 352
Carnegie, A., 219, 352
Carnot, Lazare, 352
Ceccarelli, M., 77, 145, 150, 172, 352, 353
Chanute, O., 258, 353
Chasles, M., 60, 63, 353
Chebyshev, P.L., 165, 243, 273, 353
Cialdi, Alessandro, 61, 353
Cianchi, M., 120, 353, 364, 370

- Cigola, M., 77, 145
 Claggett, Marshall, 121, 170, 353
 Clark, K., 37, 165, 289, 353, 364, 370
 Clark, W.M., 156, 353
 Cohn-Vossen, S., 162, 356
 Collins, S., 274, 353
 Cooper, M., 353, 364
 Craig, J.J., 287, 353
 Crispino, E., 364
 Cuomo, S., 114, 353

 D'Alembert, J., 147, 389
 Dasgupta, S., 353
 Daumas, M., 131, 353, 365, 370
 Davies, C., 78, 353
 de Caus, Salomon, 147, 148, 248, 353, 385
 de le Hire, Phillipe, 387
 Deleuil, 200, 353
 deSolla Price, D.J (See Price, D.J deSolla)
 Diamond, J., 6, 106, 353
 Dibner, B., 289, 353, 364
 Diderot, D., 147, 353, 389
 Denavit, J., 89, 91, 355, 370
 Dijksterhuis, E.J., 353
 diLuzzi, Mondino, 353
 Dimarogonas, A.D., 353, 367
 Drachmann, A.G., 113, 320, 353, 370
 Dudley, D.W., 194, 195, 353, 370
 Dugas, R., 150, 170, 354, 370
 Duhem, P., 69, 168, 170, 354, 364
 Dunkerly, S., 354
 Durley, R.J., 206, 354

 Eco, U., xii, 170, 236, 285, 354, 365, 370
 Egorova, O., 368
 Emerson, R.W., 233, 354
 Endrei, W.G., 199, 354
 Erdman, A.G., 91, 354, 370
 Erlande-Brandenburg, A., 182, 354
 Errard de Bar-le-Duc, Jean, 147, 354
 Essinger, J., 285, 354
 Euler, L., 81, 93, 166, 197, 241
 Evans, O., 218, 249, 354, 370

 Farey, J., 214, 221, 248, 354, 365
 Feldhaus, F.M., 64, 77, 354, 364, 366
 Ferguson, E.S., xii, 61, 66, 76, 127, 163, 173, 208, 243, 354, 367, 370, 381
 Fisher, D., 228, 360

 Fontana, Giacomo, 44, 133, 147, 171, 354, 374
 Francesco di Giorgio (See Martini, F. d.G.)
 Freudenstein, F., 354

 Galileo, Galilei, 149, 167, 171, 354
 Galluzzi, P., 44, 132, 133, 135, 137, 138, 169, 187, 262, 289, 354, 364, 366, 375
 Gardner, M., 241, 354
 Ghiberti, Bonaccorso, 133, 147, 355
 Gibbs-Smith, C.H., xii, 37, 255, 355, 370
 Gies, F., 121, 355, 364
 Gies, J., 121, 355, 364
 Gille, B., xii, 46, 121, 123, 124, 131, 141, 146, 264, 355, 364, 366, 370, 374
 Gillispie, C.C., 355, 365
 Gimpel, J., 121, 355, 370
 Giulio, 355
 Gnudi, M.T., 381
 Goldberg, M., 241, 355
 Gradenwitz, A., 208, 355, 367
 Graf von Seherr-Thoss, C., 194, 355
 Grafton, A., 125, 264, 355, 361, 366, 368
 Grese, M.A., 104, 355
 Grossman, E.D., 104, 355
 Grothe, H., 60, 61, 64, 138, 169, 195, 244, 355, 364
 Grübler, M., 90, 92, 95, 161, 312, 355, 367
 Guericke, von Otto, 147, 249
 Guido da Vigevano, 121, 123, 147, 148, 171, 355, 374

 Hachette, Jean N.P., 61, 67, 78, 84, 355, 367
 Hall, A.R., 11, 121, 122, 123, 137, 157, 355, 362, 366, 371, 374
 Hardenberg, H.H., 355, 365, 367, 370
 Hart, I.B., 37, 44, 60, 124, 125, 129, 131, 138, 168, 198, 213, 355, 364, 370
 Hartenberg, R.S., 89, 91, 355, 370
 Hartmann, W., 95, 355
 Haton de la Goupilliere, J.-N., 172, 356
 Helm M., 270, 356, 367, 368
 Henderson, D.W., 162, 356
 Heron of Alexandria, 113, 278, 356
 Heydenreich, L.H., 364
 Hilbert, D., 162, 356
 Hill, D., 373
 Hindle, B., 365

- Holmyard, E.J., 11, 121, 122, 137, 157, 362, 266, 371
Homer, 107, 356
Honnecourt, Villard de (See Villard de Honnecourt)
Hoover, H.C., 380
Huygens, C., 167, 283, 330, 356

IFToMM, xvi, 356

Jardine, L., 356
Johansson, G., 103, 356
Johnson, W.A., 200, 356
Jokish, D., 104, 356
Jones, F.D., 145, 356, 370

Kasson, J.F., 176, 356
Keller, A.G., 148, 356
Kennedy, A.B.W., 53, 80, 94, 204, 207, 356, 367
Kemp, M., 364
Kerle, M., 270, 356, 367, 368
Kim, C.Y., 104, 355
King, R., 356, 366
KMODDL, 66, 83, 88, 134, 198, 241, 284, 304, 326, 356, 370, 382, 386, 389
Knight, E.H., 356, 370
Knobloch, E., 132, 356
Koetsier, T., 149, 172, 282, 357
Kyeser, Konrad, 44, 124, 133, 147, 171, 357, 374

Laboulaye, C., 156, 270, 357, 367
Lagrange, J.L., 165, 357
Landels, J.G., 357
Lanz, P.L., 61, 67, 146, 147, 156, 357
Lardner, 214, 357
Laurenza, D., 357
Lefèvre, W., 357
Leonardo da Vinci, 9, 26, 34, 59, 63, 68, 93, 130, 131, 147, 148, 152, 153, 163, 166, 191, 196, 249, 255, 265, 277, 304, 357, 368, 369, 370
Leupold, Jacob, 27, 59, 62, 71, 135, 144, 147, 155, 160, 254, 357, 388
Libri, G., 60, 357
Lilienthal, O., 258, 357
Lipson, H., 106, 189, 209, 242, 282, 286, 358
Listing, J.B., 81, 358
Long, P.O., 358
Lubar, S., 365

MacCord, C.W., 358, 367
MacCurdy, E., 42, 161, 265, 358, 364, 369
Mahoney, M.S., 127, 358
Marey, E.J., 271, 358, 369
Martin, E., 358
Martini, Francesco di Giorgio, 39, 62, 127, 131, 133, 135, 139, 142, 147, 310, 346, 354, 378
Masi, F., 87, 88, 95, 358
Masters, R.D., 131, 358, 364
Mauersberger, K., 127, 200, 226, 358, 365, 367
Maxwell, J.C., 286
Maybe, H.H., 332, 358
Mayr, O., 112, 278, 281, 286, 358, 370
McGeer, T., 358, 369
Menschik, A., 268, 271, 358, 369
Minkowski, H., 241, 358
Moll, C.L., 197, 358, 367
Monge, G., 61, 67, 78, 160, 163, 358
Moon, F.C., 74, 143, 223, 242, 282, 284, 286, 358, 359, 365, 367
Mumford, L., 237, 359
Museo Nazionale della Scienza e della Tecnica Leonardo da Vinci, 364
Muybridge, E.J., 271, 359, 369
Mytilinaios, E., 364

Needham, J., xii, 76, 106, 314, 359, 385
Newton, I., 54, 161, 168, 359
Nicholl, C., 125, 359, 364
Nuland, S.B., 263, 359, 364, 369

Ocvirk, F.W., 332, 358
O'Malley, C., 267, 359, 389
Ord-Hume, A.W.J.G., 254, 359, 389
Ostuni, G., 123, 359

Pacey, A., 76, 359, 365
Pacioli, Fra Luca, 39, 129, 130, 164, 359
Pappus of Alexandria, 114, 359
Parks, T., 126, 359
Parsons, W.B., 359, 364, 366, 370
Paul, B., 90, 336, 359
Peaucellier, Charles-Nicholas, 243, 359
Pedretti, C., 357, 359, 364, 365, 371

- Phillips, J., 359
 Piaget, J., 103, 359
 Poggio, T., 104, 355
 Poincaré, H., 259
 Poinsoot, M., 94, 360
 Polhem, Christopher (See William A. Johnson, 1963), 199, 360
 Ponting, K., 33, 126, 360
 Pontus Hulten, K.G., 360, 365
 Popp, K., 360
 Price, D.J. de Solla, 100, 353, 360

 Rademacher, H., 241, 360
 Raibert, M.H., 273, 360, 369
 Ramelli, Agostino, 11, 26, 46, 62, 132, 147, 150, 152, 153, 269, 313, 344, 360, 380
 Rankine, W., 96, 172, 251, 360
 Read, A., 228, 360
 Redtenbacher, F., 62, 96, 147, 172, 205, 236, 270, 360, 367, 369
 Remberger, S., 360, 367
 Reti, L., xii, 5, 42, 43, 62, 135, 144, 146, 150, 153, 169, 190, 191, 213, 289, 292, 308, 316, 360, 364, 365, 371
 Reuleaux, F., 8, 11, 13, 28, 47, 50, 56, 63, 70, 80, 82, 84, 144, 146, 147, 156, 159, 172, 192, 194, 197, 236, 286, 304, 360, 361, 366, 368, 369, 371
 Rice, E.F. Jr., 125, 361, 366
 Rolt, L.T.C., 361, 366
 Rosheim, M.E., 267, 272, 276, 314, 361, 365, 369, 371, 375
 Roth, B., 361
 Ruina, A., 273, 274, 353, 361

 Sale, K., 231, 232, 361
 Sand, G., 234, 361
 Sandor, G.N., 91, 354
 Sangallo, Guiliano da, 147, 361, 375
 Sass, S.L., 361
 Saunders, J.B. De C.M., 267, 359, 369
 Scaglia, G., 135, 137, 141, 143, 265, 361
 Scherer, V., 181, 182, 361
 Schneider, M., 365
 Schreck, J. (J. Terentino or Terentius), 76, 361, 385
 Schröder, J., 203, 361
 Schubert, Johann Andreas, 361

Scientific American, 101, 208, 361
 Seiflow, G.H.F., 49, 361
 Severin, D., 361, 368
 Shepherd, D., 361
 Shigley, J.E., 91, 361
 Shiroshta, S., 280, 362, 368
 Shulman, S., 261, 362
Sibley Journal of Engineering, 362
 Siemens, Werner von, 54, 290, 362, 366
 Simone Cremante, 365
 Singer, C., 11, 121, 122, 137, 157, 362, 366, 371
 Smith, S., 362
 Snow, C.P., 175, 180, 362
 Sobel, D., 283, 362
 Standage, T., 362
 Stein, E., 360
 Stevin, 172
 Strada, Jacob de, 62, 133, 135, 147, 330, 362, 382
 Strandh, S., 170, 231, 362, 366, 371
 Strobino, G., 33, 362
 Suh, N.P., 362
 Suplee, H., 80
 Sussman, H.L., 362, 366
 Sutura, S., 362, 371
 Swade, D., 362, 366

 Taccola, Mariano, 124, 127, 131, 147, 269, 362, 369, 375
 Taddei, M., 170, 201, 257, 362, 365, 371
 Taimina, D., 162, 356
 Tao, D.C., 90, 362
 Tedrake, R., 274, 353
 Thayer, W., 362
 Thilo, O., 270, 362, 368, 369
 Thurston, R.H., 170, 180, 206, 207, 212, 221, 250, 270, 362, 366, 369
Time Magazine, 201
 Toledano, R., 257, 362
 Toeplitz, O., 241 360
 Troje, N.F., 104, 356
 Truesdell, C., 69, 168, 169, 362, 365
 Turner, A.R., 362, 365

 Ubaldo del Monte, Guido, 149, 167, 171, 362
 Uccelli, A., 362
 Uglow, J., 59, 216, 362

- Usher, A.P., xi, 363, 366, 371
Valturio, Roberto, 62, 127, 133, 147, 363, 376
Vasari, G., 129, 276, 363, 365, 366, 369
Venturi, G.B., 60, 259, 363, 365
Vesalius, Andreas, 263, 363, 369
Villard de Honnecourt, 76, 118, 121, 147, 148, 152, 278, 363, 373
Vitruvius Pollio, 43, 78, 112, 372, 363, 376
Voigt, G., 11, 143, 205, 304, 312, 363, 368
- Wang, Cheng, 76, 361, 363, 385
Wankel, F., 244, 246, 363, 366, 371
Weber, W., 352, 367
Weihe, C., 363, 368
Weisbach, J., 172, 363
Weller, A.S., 135, 144, 363
Whelan, R., 363
White, J., 363
Whitman, W., 232
Williams, T.L., 11, 121, 122, 137, 157, 362, 366
- Willis, R., 62, 70, 79, 84, 96, 146, 156, 166, 172, 178, 200, 287, 332, 363, 368, 369
Willson, F.N., 73, 163, 363
Wisse, M., 274, 353
Wittenburg, J., 363
Wood, E.H., 205, 351
Wood, G., 284, 363, 369
- Yaglom, I.M., 241, 363
Yan, H.S., 272, 363, 369
Yoshida, F., 363
- Zampieri, D.E., 368
Zanon, E., 170, 201, 157, 362, 365, 371
Zeising, H., 135, 147, 149, 363, 384
Zonca, Vittorio, 135, 147, 149, 154, 155, 254, 269, 363, 384
Zopke, H., 178, 229, 364, 368
Zorzoli, B.G., 170, 236, 285, 354
Zubov, V.P., 61, 163, 364, 365
Zykov, V., 364

Subject Index

- Aachen (Aix la Chapelle), 48
Age of Machines, 166, 223, 239
Agricola, Georgius, 46
 mining machines, 379
Airbus jet, 17
Alberti, Leon Batisti, 113, 263
Alexander the Great, 107, 110, 120
Alexandrian School, 44, 110, 149
Al-Jazari, ibn al-Razzar, 76, 118, 148, 278
 water clocks, 373
American Gear Manufacturers Association (AGMA), 195
American machine designers, 177
American Machinist, 58
American Society of Mechanical Engineering (ASME), 80, 208, 227, 252
Ampere, A.M., 26, 66
Anonymous Engineer, 133
Antikythera Mechanism, 100, 101
anti-machine voices, 231
Arab and Moslem civilization, 32, 121, 122, 148, 291
Archimedes, 44, 111, 114, 161, 162, 290, 318, 320
 screw pump, 172
Aristotle, 106, 109, 263
arithmometer, 286
artificial intelligence, 102
artist-engineers, 131, 158, 187, 190
assault towers, 123
automata, 18, 27, 32, 276-281, 284
automobiles, 19, 29
Auvergne, William, 119
Babbage, Charles, 27, 31, 32, 223, 225, 285
 difference machine, 224
Babylonian Empire, 76, 105, 116, 188
Bacon, Roger, 118, 119, 216
balance wheels, 346
balancier, 253
ball bearing, 307
ball joint mechanism, 21
Ballet Mechanique, 183
barulkos, 114
Bauman Moscow State Technical University, 304
Beck, Theodor, 63
Bellefortis, 124, 133
belt drive mechanism, 35, 68, 305, 306, 316
Benz, Carl, 28, 29, 31, 32, 33, 225, 261, 316
Berlin, 49, 178, 183, 228, 230
Berlin Industrial Academy, 48
Berlin Technical University, 173
Besson, Jacques, 46, 150, 151, 199, 268, 310, 381
 log-sawing machine, 380
 screw-cutting machine, 198, 380
Betancourt, Augustin de, 61, 180
“billig und schlecht”, 56
bio-engineering, 19
biomechanics, 268
Biringuccio, Vannuccio, 46, 378
Black, Joseph, 217, 219
Böckler, Georg Andreas, 152, 155, 385
 perpetual motion machine, 386
Borgnis, 79, 85, 157
 des moteurs animes, 268

- man in the machine, 269
 Boston Museum of Science, 156, 312, 314, 326
 Boulton, Matthew, 213, 216, 220
 Bramah, Joseph, 223
 Branca, Giovanni, 386
 Briefe aus Philadelphia, 50, 229
 British Museum, 100
 Brown, Henry T., 156, 157, 312, 324, 326
 Bruegel, Pieter, 184, 185
 Brunel, Marc I., 223
 Brunelleschi, Filippo, 38, 77, 129, 133, 199
 Buch der Erfindungen, The Book of Inventions, 11–13, 50, 57, 156, 178
 Burmester, L., 165, 241
 Bush, Vanemar, 242
 Butler, Samuel, 233

 CAD (Computer Aided Design), 209, 211
 calculating machines, 223, 242
 Calder, Alexander, 179
 Cambridge University, 287
 cam mechanism, 7, 144, 240, 282, 305, 306, 342
 positive return 297
 Capek, Karel, 281
 Cardan suspension, 314
 Cardano, Fazio, 129
 Cardano, Girolamo, 194, 279
 Carnot, Lazare, 61
 Carnot, Nicolas L.S., 249
 catapults, 33, 114, 372
 Centennial Exhibition of 1876, Philadelphia, 15, 56
 centrodes, 53, 71, 73, 240
 chain drives, 307
 chain of pots, 76, 152
 chamber crank trains, 244
 Chaplin, Charles, 182, 238
 chaos in ball bearings, 74
 in gears, 74
 Chaos theory, 74, 172
 chariots, 34, 116
 Chasles, M., 60, 63
 Chebyshev, Pafnutil L'vovich, 90, 165, 221, 243, 272, 287
 passive walking machine, 273
 China, 76, 106, 108, 122
 Chinese walking horse, 272

 Chanute, Octave, 258
 cinématique, 66
 Clark, Kenneth, 37, 165
 Clark, William M.
 models, 156, 304, 312, 314, 328
 Clement, Joseph, 223
 clepsydra, 121
 clocks, 18, 74, 126, 276, 282, 283, 305
 clock escapements, 51, 76, 126, 206, 278
 pendulum, 283
Codex Atlanticus, 4, 26, 34, 42, 60, 64, 144, 189, 276
 facsimile, 63
Codex Madrid, 9, 10, 16, 24, 25, 26, 27, 42, 66, 68, 130, 133, 141, 144, 162, 189, 263, 303
Codice Ashburnham, 361, 144
Codice sul volo degli uccelli (1505), 41
 (on the flight of birds) 261
 cognitive science, 102, 105
 Colmar, Thomas de, 286
 (see also arithmometer)
 Columbian Exposition of 1893, Chicago, 50, 56, 180
 compliant mechanisms, 18, 303
 constructive elements, 7, 28, 53, 190, 303
The Constructor, or “The Designer” (1861–1893), 5, 7, 80, 159, 178, 197, 281
 Der Constructeur (1861), 50, 194
 Der Constructor, 28
 controlled machines, 276
 control valves, 328
 Corliss engine, 15
 Cornell, Ezra, 227
 Cornell University, 7, 53, 134, 148, 205, 212, 229, 244, 252, 258, 274, 279, 304
 collection of kinematic models, 66, 83, 200, 295, 296, 297, 298, 299, 300
 couplings, 307
 cranes, 113, 114, 133, 152, 182
 crank mechanisms, 7, 144, 303, 305
 cross bows, 33, 34
 crown-wheel, 23
 Ctesibius, 44, 111, 112, 149, 253, 278
 “Cultur und Technik”, 50
 Curtiss, Glenn, 255, 258, 261
 curves of constant breadth, 239
 cybernetic machines, 281
 cylinder and piston, 215

- d'Alembert, Jean, 389
De divina proportione, 39, 129, 130
 De le Hire, Phillipe, 387
De re militari, 133
 degrees of freedom, 70
 descriptive geometry, 75, 78, 160, 163
 design theory, 56
 Deutsches Museum, 7, 53, 159, 206, 208,
 227, 244, 260, 270, 304, 338
 Diderot, Denis, 389
 digital machines, 285
 dolls, 284
Domesday Book, 118, 121
 double slider mechanism, 36, 244
 Dresden Technical University, 200
 Duhem, Pierre, 69
 Durer, Albrecht, 181, 184., 195
 dynamics of machines, 74, 291
- eccentric crank mechanisms, 83, 305
 Ecole Polytechnique in Paris, 29, 61, 67, 75,
 78, 96, 160, 162, 225, 228, 250
 Egypt, 76, 105, 108, 110, 116, 188
Ehewhon, 233
 Eidgenössische Technische Hochschule
 (ETH), 48
 "elementi macchinali", 303, 326
 Ellipsenzirkel, 244
 Emerson, Ralph Waldo, 233
 endless screw, 36, 76, 184, 191, 306, 318, 384
 Engelberger, Joseph, 282
 engines, 32
 Enlightenment, 60
 epicycloids, 72, 336
 Errard de Bar-le-Duc, Jean
 textile spinning devices, 382
 windmills, 382
 escapements, 34, 68, 283
 anchor, 283
 crown wheel, 330
 cylinder, 284, 299
 deadbeat, 283
 gravity, 284
 three-tooth, 387
 verge and foliot, 283, 306, 331
 Eschweiller-Pumpe, 49
 Euler, Leonard, 81, 160, 166, 171 197, 241,
 332
 Evans, Oliver, 218, 219, 249, 281
- evolution of machine design, 145
 evolution of mechanisms, 156
- Feinmechanik, 140
 Feldhaus, Franz M., 64
 Ferguson, Eugene, 173, 208
 Florence, 37, 123, 126, 129, 133, 140, 144,
 200, 201, 290
 Florentine Academy, 129
 flying machines, 65
 flywheels, 306
 Fondazione Scienza e Tecnica, 200, 204, 304
 Fontana, Giovanni, 374
 winged devil automata, 375
 four-bar mechanism, 21, 24, 72, 79, 85, 243,
 257, 271, 300, 306, 308, 309
 four-wheeled carts, 148
 Franklin, Benjamin, 176
 French King, Francis I, 41
 friction, 167, 168
 friction wheel mechanisms, 305, 306, 338,
 340
 fused deposition modeling (FDM), 209
 Futurist movement, 183
- Galen, 263
 Galileo Galilei, 149, 150, 167, 171
 Ganson, Arthur, 179, 180
 gas engine, 222
 gear(s), 133
 bevel, 195, 306, 338
 conical, 195
 crown wheel, 21, 322
 design, 194
 globid, 192, 318
 lantern pinions, 195
 spur, 195
 stepped drum, 285
 teeth, 182, 299
 spur gear, 332
 tooth profiles, 305
 trains, 306
 epicyclic, 216, 336
 planetary, 297, 300
 gear-pinion mechanism 21, 24
 Geneva wheel mechanism, 296, 326
 geometrica situs, 81
 geometry, 18, 162, 175, 190, 264, 291
 of motion, 72

- Gewerbe Akademie, Berlin, 48, 207, 229
 Ghiberti, Bonaccorso, 133
 gimbal bearings, 306
 Glasgow, 215, 217, 219, 253
 Göethe, 54
 golden mean, 178, 264
 governors, 286
 Greece, ancient, 100, 106
 Grosseteste, Robert, 119
 Grothe, Hermann, 61, 63, 260
 Grübler, Martin, 90, 161
 mobility criterion, 89, 93
 Guatelli, Roberto, A., 201
 Guido da Vigevano of Pavia, 123
 folding bridge pontoon, 374
 four-wheeled battle wagon, 374
 guilds, 215, 290
 Gutenberg, 127
- Hachette, Jean N.P., 61, 62, 78
 Harrison, John, 283
 Hauch Collection, Denmark, 199
 Hero of Alexandria, 62, 111, 113, 161, 212, 278, 290
 aeolipile, 212
 Homer, 106
 Hooke, Robert, 88, 175, 251
 Hooke's joint, 83
 Hoover, Herbert C., 380
 Huygens, Christian, 283, 330
 hypocycloids, 336
- IBM Museum, 201
 Il Moro, 39
 Illinois Gear Company, 298
 India, 50
 Industrial Age, 100
 Information Age, 16
 influence networks, 44, 45, 55, 105, 292
 instant centers, 71
 intermittent mechanism, 35, 36, 195, 306, 326
 internal combustion machines, 18, 222
 International Exhibition, Vienna, 212
 International Expositions, 47
 International Federation for the Theory of Mechanisms and Machines, IFToMM, xvi, 239
 invention, 188, 291, 215
- avalanche theory, 261
 general laws of, 57
 societal conditions, 99
 inventors, 223
- Jacquard, Joseph-Marie, 285
 loom, 281
 textile machine, 282
 Jaquet-Droz, Pierre, 285
 Japanese tea-serving automata, 280
 Johansson, Gunnar, 103
 Junkers, Hugo, 226, 261
- Karakuri doll, 280
 Karlsruhe Polytechnique Institute, 48
 Kennedy, Alexander, B.W., 53, 71, 80, 204, 207
 Kensington Exhibition of 1876, London, 205
 kinematic chains, 7, 15, 31, 70, 71, 72, 80, 85, 87, 94, 303, 305
 closed, 70
 open link, 70
 kinematic design, 172
 kinematic mechanisms, 19, 203, 282
 model collections, 204, 200
 kinematic pairs, 6, 30
 higher element, 30, 70, 141, 239, 305
 lower element, 30, 70, 141, 239, 305, 320
 kinematic perception, 102, 103
 kinematic synthesis, 53
 kinematics, 26, 53, 74, 138, 239, 291
 geometry of motion, 66
 human motion, 262
 inversions, 82, 88
 path points, 73
Kinematics of Machinery (1876), 7, 8, 50, 72, 80, 85, 163, 179, 220, 244
 kinesiology, 262, 271
 kinetic sculpture, 179, 105
 Alexander Calder, 179
 Arthur Ganson, 179
 George Rhoads, 180
 Jean Tinguely, 179
 Kirchhoff, 81
 Kirchhoff's circuit law, 94
 KMODDL, 66, 88, 93, 134, 148, 197, 198, 200, 243, 284, 304
 Koch Modellwerk, 203
 Kyser, Konrad, 78, 124, 133, 148

- paddle wheel boat, 374
- Laboulaye, C., 156
- LaGrange, J.L., 66, 150, 161, 165
- La Machine Animal*, 271
- Langen, Eugen, 54, 222, 225
- language of invention, 106
- language of machines, 77
- Lanz, Phillipe Louis, 61
- lathes, 113
- lazy tongs (see also Nürnberg shears), 93, 124, 306, 312, 376
- Leibnitz, Gottfried, W., 161, 285
- Leonardo da Vinci, 37, 39, 52, 57, 76, 77, 96, 121, 124, 126, 129, 133, 140, 152, 153, 161, 189, 289, 303
- anatomical drawings, 262, 266
- anatomy, 170, 264, 265
- automaton three-wheeled cart, 280
- avalanche model for invention, 191
- basic machine elements, 191
- belt and rope drives, 316
- biographies of, 37
- canals and pageants, 39
- Cardano, Fazio, 39
- clock technology, 126, 236
- Clos-Luce Amboise models, 201
- Codex Atlanticus*, 42
- Codex Madrid*, 42
- drawings of machines, 37, 154, 63, 131
- ellipse-drawing mechanism, 60
- endless screw, 318
- as engineer, 38
- escapements, 330
- expansion of water into steam, 249
- experimentation, 218
- flight of birds, 41, 255
- Florence, 37
- flying machines, 255
- four-bar linkage, 21, 308, 309
- Francesco di Giorgio Martini, meeting with, 39, 131
- friction, 75, 340
- gear systems, 195, 196, 332
- gimbals, 314
- globoid gear design, 191
- helical screw mechanism, 69, 321
- his library, 39, 42, 130, 148
- hydrodynamics, 41
- influence network, 44, 59
- intermittant mechanism, 326
- inventions and inventors, 169, 190
- lazy tongs or Nürnberg shears, 94, 312
- lunate drawing, 240
- machine elements, 64
- machines, 34
- mechanics, 41, 167
- planetary gear, 68, 197, 336
- rack and pinion, 334
- ratchet, 328
- reversing or mangle, 324
- screw jack, 320
- slider crank, 24, 310
- and the Medici, 125
- Manuscript A–M*, Paris, 4, 40, 42, 60, 64, 128
- Manuscript B*, Paris, 60
- Milan, 39, 126, 127, 129, 133, 201
- models, 200
- Pacioli, Fra Luca, 39
- paintings
- Benois Madonna, 37
 - Ginevra de' Benci, 37
 - Last Supper, 39
 - Madonna and child, 37
 - Madonna of the Yarnwinder, 37, 157
 - Mona Lisa, 41
- path points, 166
- Pavia, 39
- robot, 267, 276
- steam cannon, 215
- steam power, 213, 249
- textile industry, influence of, 126
- textile spinning machine, 35
- thrust bearing, 68
- Vitruvius, 42
- wing designs, 202, 257
- winged angel, 257
- yarnwinder, 157, 186
- Letters from Philadelphia (see *Briefe aus Philadelphia*), 56, 229
- Leupold, Jacob, 155, 388
- Libri, Guillaume, 60
- Lilienthal, Otto, 54, 65, 226, 255, 258, 260
- Linde, Carl, 226
- linkages, 68, 70, 191
- eight-bar, 92, 231
- Linnaeus, Carolus, 67, 85

- Lipkin, 165
 London Exhibition of 1851, 204
 London Science Museum, 205
 Luddites, 231
 Lyapunov, A.M., 287
- McGill University, kinematic model
 collection, 205
 Henry Bovey, 206
 Gustav Voigt, 206
- McNeil, Herman Atkins, 180
- Machine Age, 7, 84, 177, 228
 (see also Age of Machines)
- machines, 70
 aesthetics in design, 176-178
 ancient times, 100
 and architecture, 77
 in art, 181, 187
 in the Bible, 116, 117
 construction, 34, 20, 51, 132, 152, 182
 design, 172, 190, 103, 198, 239
 elements, 29, 124, 139, 143, 155
 evolution of, 99, 118, 145, 150
 language of, 106
 log-cutting, 119, 151, 154
 manufacturing, 19, 34, 51
 mechanics of, 170
 military, 34, 51, 123, 126, 153
 mills, 132
 pontoons, 124
 power and transmission, 51
- Magnus, Albertus, 119
- Maltese cross mechanism, 326
- man in the machine, 268
- mangle mechanism, 36, 324
- Marey, Etienne-Jules, 271
- Martini, Francesco di Giorgio, 4, 34, 42, 59, 62, 77, 78, 119, 124, 127, 131, 135, 137, 139, 265, 310, 318, 320, 378
 Leonardo da Vinci, meeting, 39 131
 machine drawings, 139
 military fortresses, 136
 rack and pinion, 334
 Taccola, influence of, 133
 Urbino, carved panels of machines, 137
 water pumps, 142
 wheeled vehicles, 142, 143
 wing, 257
- Maschinenbau, 193
- mathematical drawing instruments, 151
- mathematics, 160, 161, 164, 168, 175, 215, 217, 218, 290
- Maudslay, Henry, 223
- Maxwell, James Clerk, 286
- measurement devices, 34
- mechanical alphabet, 200
- mechanical calculators, 282, 285
- mechanical notation, 31
- mechanics, 169, 170, 172
- mechanisms, 31, 70, 102
 compound, 84, 90
 force closed, 70
- mechanism models in Berlin, 53
- mechatronics, 16, 21, 33, 280
- Medici
 Cosimo, 37, 125
 Family, 125, 375
 Francesco I, de', 181, 199
 Library, 133
 Lorenzo de, 37
- Mendeleyev, 67, 84
- Merton College, 66, 170
- Mesopotamia, 108
- micro-electromechanical systems (MEMS), 17, 18, 27, 33, 285
- Middle Ages, 100, 118, 124, 170, 215, 216, 278, 291
- Milan, Duke of, 189, 201, 290
- military engineers, 113, 126, 131, 152
- Minkowsky, 241
- MIT Museum, 181
- mobility criterion, 70, 89
- model collections, kinematic mechanisms, 128, 204
- models, 7, 49, 128, 199
 Clark, 156, 204, 304
 Clos-Luce Amboise, 201
 Cornell University, 204, 206
 Redtenbacher, 198, 204, 304
 Schröder, 200, 203, 204
 Voigt-Reuleaux, 205, 264
- modular elements, 190
- Moll, Carl L., 50, 203
- monasteries, 122
- Monge, Gaspard, 61, 67, 75, 78, 160, 163
- Morse, Samuel, 227
- Mumford, Lewis, 237
- Mussolini, 201

- Muybridge, Eadweard J., 271
- Napier, double screw of, 324
- Nasmyth, James, 223
- National Library of Spain, 4
- Newark Museum models, 156, 204
- Newcomen, Thomas, 213, 252
 steam engine, 217
- Newton, Isaac, 54, 74, 161, 171
- non-holonomic constraints, 74
- Nürnberg shears linkage, 93, 312
 (see also lazy tongs)
- ornithopter, 255
- Otto-Langen gas engine, 261
- Otto, Nicholas, 32, 222, 225, 229, 290
- Oresme, Nicole, 168
- Pacioli, Fra Luca, 39, 129, 130, 164
- pantograph, 312
- Papin, Denys, 215, 218
- Pappus of Alexandria, 114
- parallel guide mechanisms, 305
- Paris Manuscripts, A–M*, 34, 241
- Pascal, Blaise, 285
- Peaucellier, Charles Nicolas, 165, 243
 straight-line mechanism, 93, 243
- Peaucellier–Lipkin mechanism, 243
- Pedretti, C., 359, 371
- periodic table of chemical elements, 79, 84
- Peripatetic School of Aristotle, 108
- perpetual motion machines, 253
- Philadelphia 1876 Centennial Exhibition, 14, 61, 176, 207
- Philo of Byzantium, 111
- phronomy, 74
- Piaget, Jean, 103
- Picabia, Francis, 183
- planetary wheel chains, 305
- Polbahnen, 71, 72
- Polhem, Christopher, 199
- polyspaston, 114
- Polytechnisches Arbeitsinstitut Darmstadt, 203
- Polytechnische Schule at Karlsruhe, 225
- potter’s wheel, 108
- precision engineering, 140
- Price, Derek J. de Solla, 100
- prime movers, 27, 32, 248
- printing technology, Renaissance, 127
- prismatic joint, 30, 303
- Prussian Society for the Advancement of Industry, 80
- Ptolemaic geocentric theory, 72
- pulley chain, 7, 144, 303, 307
- pump of Ctesibius, 372
- pumps, 76, 113, 114, 344
 double piston, 141, 149, 154, 376
 positive displacement, 295
 spiral positive displacement, 298
- puppets, 279
- quadrivium, 129
- Qi Qi Tu Shou*, 76
- rack and pinion mechanism, 299, 306, 334
- Raibert, hopping machines, 273
- Ramelli, Agostini, 46, 150, 152, 380
 pump-engines, 344
- Rankine, William J.M., 158, 251
- Rapid prototyping, 209, 312, 318
- ratchet chain, 144, 303
- ratchet mechanism, 7, 28, 191, 195, 306, 328
- ratchet wheel, 296
- Redtenbacher, Ferdinand, 193, 205, 225, 226, 229, 236
 humans and animals as motors, 269
 kinematic models, 198, 304
- regulator, 281
- Renaissance, 7, 138, 145, 150, 158
 Age of machines, 125
- Reti, Ladislao, 5, 42, 62, 142, 153, 213, 303
- Reuleaux, Franz, 5, 47, 65, 74, 80, 83, 96, 105, 139, 140, 156, 157, 161, 163, 177, 193, 289, 303
 aesthetic principles in design, 178
 art, 178
 basic machine elements, 43
 Belgian roots, 220
 “billig und schlecht”, 50
 Borgnis, 268
 Colombian Exposition of 1893, 50, 56
 critics, 290
 Cultur und Technik, 236
 death, 58
 on dynamics in machines, 74, 167
 on education, 52
 family, 49

- Charlotte Overbeck, 49
 Eugen, 49
 Johannes Jacob, 49
 Oscar, 49
 Francesco di Giorgio, comparison with,
 139, 140
 gear design, 197
 gear friction loss, 197
 gear train models, 198
 as German ambassador to World
 Expositions, 56
 Gewerbe Institute, Berlin, 48, 207
 guidelines for machine design, 194
 Hiawatha translation, 50
 influence network, 55
 internal combustion engine, 18
 international expositions, 230
 on invention, theory of, 57, 193
 kinematic models, 206, 304
 kinematics of animals, 265, 268, 270
Kinematics of Machinery, 85, 142
 language of invention, 76, 106
 Leonardo da Vinci's drawings, 9, 10, 43,
 63
 Lilienthal, Otto, 65, 257
 Leupold, Jacob, influence of, 55, 71
 machine kinematics, 71
 machines in *The Constructor*, 51
 Mannesmann Brothers, 226, 229, 290
 models of kinematic mechanisms, 84,
 203
 Moll, Carl, 50, 203
 monument, 231
 Otto and Langen, 222
 Philadelphia Centennial Exposition 1876,
 50, 56, 61
 Prussian patent board, 194
 as rector of Berlin Technical University,
 229
 rotary piston machines, 245
 "School" of kinematics, 95
 spindle-whorl collection, 49, 157
 steam engine, 221
 straight-line mechanisms, 244
 Thomas tens-carry mechanism, 286
 Thurston, Robert, 212, 222, 227, 252
 triangle, 73, 239, 240
 Watt, James, 219
 Willis, Robert, influence of, 70, 84
 Reuleaux–Voigt models, 205, 295, 296, 297,
 298, 299, 304, 308
 belt and rope drive mechanisms, 316
 friction wheel mechanisms, 340
 gear teeth, 332
 Geneva mechanism, 296, 326
 parallel mechanisms, 312
 planetary gear systems, 297, 336
 positive-return cam, 297, 342
 ratchet mechanism, 296, 328
 reversing mechanism, 322, 324
 screw mechanism, 320
 slider-crank mechanism, 310
 universal joint, 83, 295
 verge and foliot escapement, 330
 worm drive mechanism, 318
 reversing mechanism, 306
 revolute joint, 30, 70, 303
 Rhoads, George, 180
 robotic manipulator arm, 20
 robots, 17, 19, 280
 rolling constraint, 58
 rotating ball mechanism, 216, 281
 rotating ball regulator, 286
 Rosheim, Mark, 276, 280
 rotary piston engines, 194, 239, 244
 rotary pump, 86
 Royal Technical University, Berlin, 48
 Royal Industrial Academy, Berlin
 (Königliche Gewerbe Akademie), 65, 229
 Ruina, Andy, 273
 walking machines, 274
 Sand, George, 234
 Sangallo, Guiliano da, 44, 133, 375
 Savery, Thomas, 215
 Scholastics, 99
 Schoolmen, 66, 168, 170, 216
 Johann Schreck (J. Terentius), Jesuit
 Missionaries, 385
 Schröder, Jacob Peter, 203
 models, 200, 203, 300
 Science Museum in London, 240
 scientific cabinets, 199
 screw joint, 30
 screw mechanisms, 7, 144, 303, 305, 306,
 320
 scriptoria, 127
 Sellers, William, 177

- servo-mechanisms, 281, 286, 287
 Sforza, Ludovica, 38, 126
 shadoof, 253
 Shubert, Johann Andreas, 200
 siege machines, 372
 Siena, 135
 Sienese engineers, 138
 Siemens, von Werner, 229
 Siemens, Werner, 47, 54, 235, 290
 simple machines, 28, 66, 76, 79, 106, 107,
 117, 141, 149, 170
 inclined plane, 28, 66
 lever, 28, 66, 68
 pulleys, 28, 35, 66, 307
 screw, 28, 66, 68, 85
 wedge, 28
 winch, 28
 slider-crank mechanism, 21, 23, 24, 82, 85,
 88, 210, 244, 303, 306, 310
 Smithsonian Institution, 49, 259
 Snow, C.P., 175
 Soho manufactory, 216
 Salomon de Caus, 213, 218
 automata, 385
 space technology, 19
 spherical four-bar linkages, 314
 spindle whorls, 157
 steam engine, 16, 188, 193, 212, 232, 248,
 303
 high pressure, 218
 steam turbine, 222
 Stephenson, George, 89
 reversing linkage, 213
 stereolithography (STL), 209
 Stevens Institute of Technology, 180, 212,
 227, 252
 Stieglitz, Alfred, 54
 Strada, Jacobus de, 382, 383
 straight-line mechanisms, 91, 93, 216, 221,
 241, 305
 Studiolo, Florence, 181, 199
 Su-Sung Chinese clock, 278
 Suplee, Henry, 80
 Sweet, John E., 227
 Swiss Federal Technical University
 (ETH), 48
 Sylvester, 90
 symbol notation, 54, 84
 synthesis in design, 53, 56, 71, 106, 161, 193
 Taccola, Mariano de Iacopo (aka Marianus
 Jacobus Taccola), 4, 39, 78, 124, 127,
 131, 132, 135, 183, 265, 375
 perpetual motion wheel, 376
Teatrum Machinarum Generale (of Leupold),
 59
 Technische Hochschule Berlin-
 Charlottenburg, 206, 229, 230
 Technische Hochschule Dresden, 90
 technology and society, 105
 tens-carry mechanism, 285
 Terentius, Johann (see Johann Schreck), 76
 textile machines, 33, 34, 124, 126, 285
 theatre of machines books, 65, 127, 147,
 153, 199, 249, 253, 372
 thermodynamics, 172, 217, 219, 248, 249
 first law of, 250
 Thilo, O., 270
 Thomas arithmometer, 51, 242
 Thurston, Robert, 158, 180, 206, 207, 212,
 221, 222, 227
 first president of ASME, 252
 materials of engineering, 251
 The Animal as a Machine, 270
 Tinguely, Jean, 179
 toothbrush kinematics, 15, 20, 22, 23
 toothed wheels (gears), 35, 68, 195, 332
 topological ideas, 77, 80
 topological synthesis, 81
 topology, 18, 81, 175
 rubber sheet, 81
 transportation machines, 51
Trattato di Architettura, 137
 treadmill winch, 183, 186
 trebuchet machines, 116, 124, 377
 trivium, 129
 Truesdell, Clifford, 69, 168, 169
The Two Cultures, 175, 180
 Type synthesis, 161
 Ubaldo, Guido del Monte, 149, 150, 171
 United States Military Academy, 78
 universal joint, 83, 85, 206, 279, 295, 306,
 314
 University of Porto, Portugal, 7, 204
 Urbino, 127, 137, 187
 Valturio, Roberto, 127, 133, 148, 376
 chariot with scythe blades, 378

- value mechanism, steam engine, 300
- Van Gogh, Vincent, 186
- Vasari, Giorgio, 129, 170, 189, 267
- Vaucanson, Jacques, 284
- Vecchietta, 136
- Venturi, Giovanni Battista, 60
- Verrocchio, 37, 127
- Vienna Exposition of 1893, 206, 212, 227
- Villard de Honnecourt, 44, 118, 119, 152, 278, 314
 - log-cutting machine, 373
- visual knowledge, 128, 208
- visual motion perception, 103
- visual thinking, 173
- Vitruvius, Pollio, 62, 78, 106, 111, 112, 113, 141, 146, 264, 290, 372
- Voigt, Gustav, 143, 205, 304
- Voigt Catalog of Reuleaux Models*, 11, 91, 304
- Voigt–Reuleaux models, 205

- walking machines, 271
- Wang Cheng, Chinese engineer, 76, 385
- Wankel, Felix, 244
 - Rotary engine, 194
- war machines, 113, 132
- water clocks, 114, 121, 122
- water mill, 122
- water pumping machines, 150, 153
- water wheels, 344
- Watt, James, 32, 47, 52, 89, 165, 188, 212, 220, 243, 253, 281
 - straight-line mechanism, 165, 220
- Weisbach, Julius, 193
- wheel and axle, 28
- wheel chains, 7, 144
- wheeled chariot, 109
- White, Andrew Dickson, 205, 212
- Whitman, Walt, 232
- Whitworth, Joseph, 223
- William the Conqueror, 121
- Willis, Robert, 27, 62, 77, 79, 96, 156, 178, 195, 224, 225, 287
 - biomechanics, 268
 - mechanical models, 200
 - mechanical notation, 84
- windmill, 122, 172, 186, 388
 - post, 185
- wind power, 32
- Woolf steam engine, 240
- workshop engineering, 223, 226, 290
- world expositions, 56
- World Exhibition in Vienna, 270
- worm gear drive, 197, 210, 298, 306
- Wright Brothers, 255, 259
- Wright, Michael, 100

- Zeising, Heinrich, 384
- Zibaldone*, 133
- Zonca, Vittorio, 149, 155, 384
- Zurich Polytechnique (ETH), 48
- Zwinger in Dresden, 199

About the Author



Francis C. Moon is the Joseph Ford Professor of Mechanical Engineering in the Sibley School of Mechanical and Aerospace Engineering at Cornell University. He served as director of this school from 1987–1992. He is an elected member of the US National Academy of Engineering. Moon's research interests have ranged from nonlinear and chaotic dynamics in mechanical systems to magnetic levitation of trains. He has published five books in applied dynamics. Moon has given more than 40 invited lectures at American universities and over 40 international lectures. He was a Humboldt-Stiftung Preisträger in 1988 and was the winner of the 2007 Lyapunov Award by the ASME Design Division for lifetime contributions to nonlinear dynamics. For the past decade he has studied the life and kinematics contributions of Franz Reuleaux including a 2001–2 research visit to the Deutsches Museum and Archives sponsored by the Humboldt Stiftung. He is currently the Curator of the historic Cornell Collection of Kinematic Models and is a member of the Commission on History of the Theory of Machines and Mechanisms of the International Federation for the Theory of Machines and Mechanisms (IFTToMM).