

Sirios™ - Roller Blind for Windows by Umbra
in Blindspace® S100x100

HEAD BOX S100x100SS

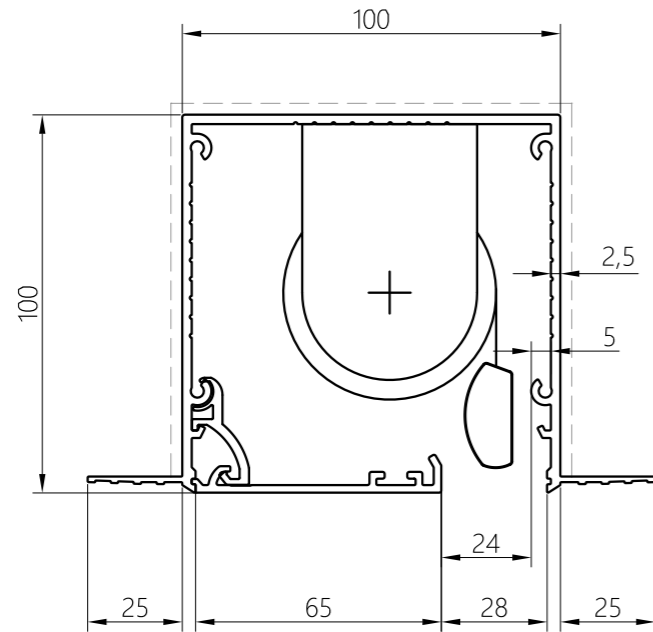

1:2 scale

PRODUCT REFERENCE

S100x100SS
SERIES SIZE CORNERS

CONCEALMENT CONFIGURATION



Head Box

BOX VARIATIONS

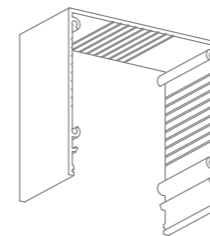

S100x100NN
No Flanges

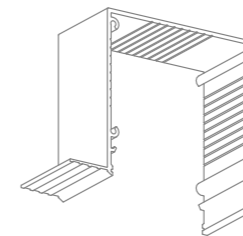

S100x100NS
Skim Coat Flange
on one side
(reversible)

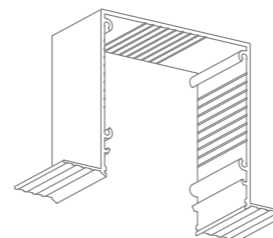

S100x100SS
Skim Coat Flange
on both sides



COVER HINGE
to hold cover plate,
installed on either side

Product	Umbra solution for blinds in dedicated concealed Blindspace® boxes
Description	Recessed roller blind application concealed in dedicated box with hinged cover flush with wall or ceiling finished surface.
Blind sizes	Please see size chart and supplier details for blind sizes such as max. width, height and area.
Finishes	Provided in RAL 9016 (white) Optional powder coating to other RAL colours available.
Material	Powder Coated Aluminium, EN 6063 T6
Optional accessories	End cap Splice pin (to align boxes) Splice plate (to align covers) Chain guide (for manual blinds) Covers in various widths
Box length	6000mm Cut to size for shorter lengths. Spliced together for longer lengths.
Installation	Boxes to be fixed with countersunk screws every 200mm through back (and both flanges when available) into appropriate backing. Scrim tape to be used on flanges. Finished plaster level to be flush with cover. Allow 3mm recess space for ease of installation, shown in dash line around boxes
Print date	2023/12/21
Page size	ISO A3 420x297

