

Steering Wheel Controller | Harley Davidson | 350

→ Vehicle Installation Instructions

The instructions below will guide you through installation of the Steering Wheel Controller in your vehicle.

Connections

Aftermarket Radio Harness

1. Connect **Pin 6 (Black wire)** of the Steering Wheel Controller harness to the **Black** ground wire of the aftermarket radio.
2. (**IMPORTANT**) Connect **Pins 1 (Pink/White wire)** and **8 (Orange/Black wire)** of the bike's radio harness to **Pin 6** of the Steering Wheel Controller harness and the **Black** ground wire of the aftermarket radio (shown below).
3. Connect **Pin 12** of the Steering Wheel Controller to the **RED** accessory wire of the aftermarket radio.

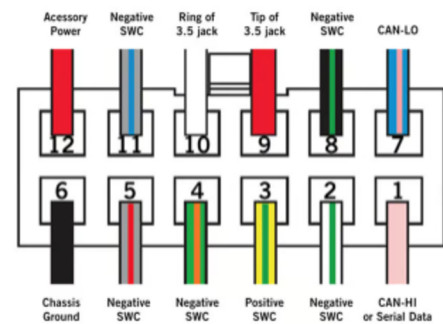
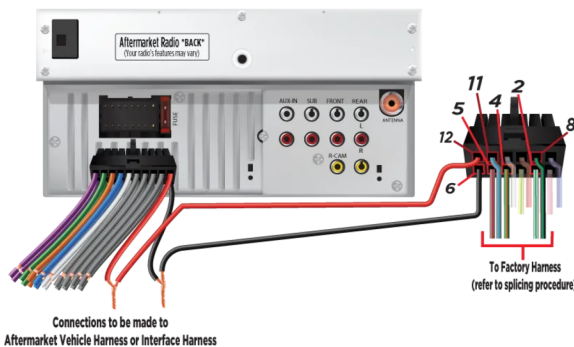

Vehicle Connection(s) to Factory Harness

1. Connect **Pin 4** of the Steering Wheel Controller (**Green/Orange** wire) to the wire in **Pin 3 (Gray/Green wire)** of the bike's radio harness.
2. Connect **Pin 8** of the Steering Wheel Controller (**Black/Green** wire) to the wire in **Pin 4 (Green/Blue** wire) of the bike's radio harness.
3. Connect **Pin 2** of the Steering Wheel Controller (**White/Green** wire) to the wire in **Pin 5 (Brown/White** wire) of the bike's radio harness.
4. Connect **Pin 5** of the Steering Wheel Controller (**Gray/Red** wire) to the wire in **Pin 6 (Grey/White** wire) of the bike's radio harness.
5. Connect **Pin 11** of the Steering Wheel Controller (**Gray/Blue** wire) to the wire in **Pin 7 (Violet/Black** wire), and splice a **1K Ohm 1/4 watt** resistor to the connection point of **Pin 11 and Pin 7**.
6. Connect the other end of the **resistor** to **Pin 2 (Brown/Black** wire) of the bike's radio harness.

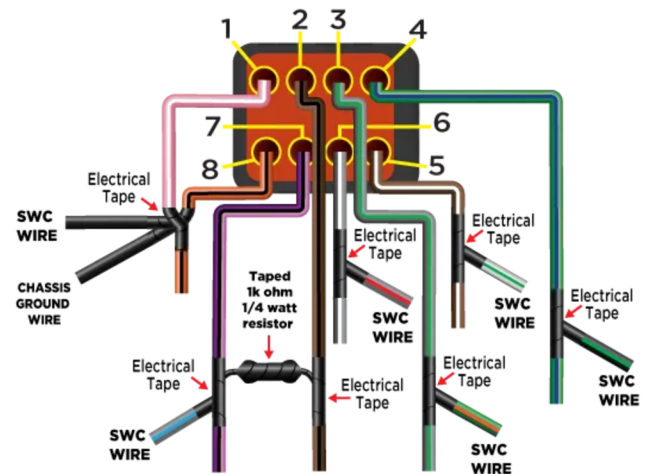

Wire color depicted does not necessarily represent the actual wire color in the vehicle.

Connections (cont.)

SWC 3.5 Jack Connections

For radios with a 3.5mm port located on the rear, plug the male 3.5mm jack directly into the back of the radio.

1. Connect the **3.5mm Jack** to the SWC (Steering Wheel Control) input on the back of the radio.

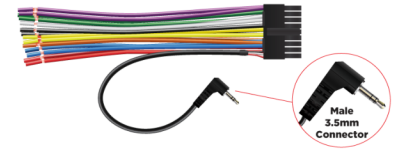

Kenwood/JVC Radios with Single SWC wire

1. Connect the **Blue/Yellow** wire labeled **Steering Wheel Remote Input** to the **Brown** wire of the female 3.5mm jack.
2. Plug in the male 3.5mm jack into the female 3.5mm jack.

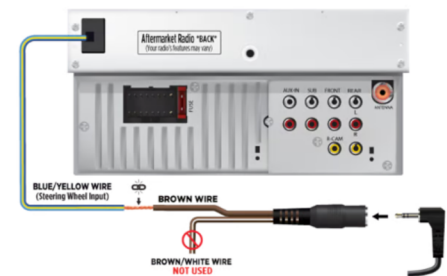

NOTE
Programming instructions on the following page.

Programming the Steering Wheel Controller

In order to effectively program the Steering Wheel Controller, the aftermarket radio needs to be (or remain) completely wired. The Steering Wheel Controller harness should be wired and the (Steering Wheel Control) SWC 3.5mm Jack or SWC wiring should be connected.

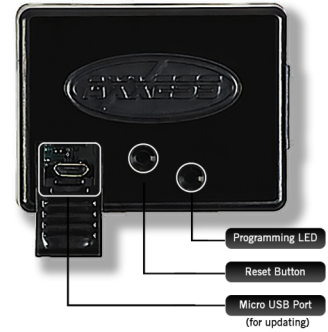

Follow the steps below to programming the Steering Wheel Controller to your vehicle:

1. Open the driver's door. **Keep it open during the programming process.**

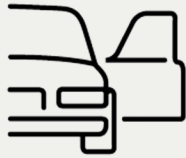

2. Turn the vehicle's ignition **On**.



3. Plug in the **Steering Wheel Controller**.



4. The LED on the SWC begins rapid flashing **Green** and **Red**.



5. **(Optional)** If the LED does not turn on, refer to **Connections** above and ensure all steps were performed precisely.



6. Hold the **Volume Up** button on the steering wheel.

7. **(Optional)** If the **Green** and **Red** flashes are missed, reset the **Steering Wheel Controller** and restart the programming process from the beginning.

8. The Steering Wheel Controller programs to SWC. Seven (7) **Green** LED flashes indicate vehicle type. After detection, LED pauses 1–2 seconds.



9. The LED flashes **Red** while the interface programs to the aftermarket radio. Feedback varies by model (**AXSWC** vs. **AXSWC-2**); confirm your model and follow the correct section below.

- **AXSWC**: A series of up to twenty-four (24) **Red** LED flashes identifies the detected Radio Type.
- **AXSWC-2**: A series of **Red/Green** LED flashes identifies the detected Radio Type.



10. Upon successfully programming, the LED turns solid **Red**.



11. Test all functions of the Steering Wheel Controller installation for proper operation.

